

PARTS CHECKLIST

1. Handset
2. Base Unit
3. Wall Mounting Bracket
4. AC power Adaptor
5. Telephone Line Cords (x2)
Short Telephone Line Cord
6. Battery Pack

7. Short Line Cord
8. Belt Clip

To purchase replacement battery packs, call **VTECH** Communications at 1-800-595-9511. In Canada, call VTECH Electronics at 1-800-267-7377.

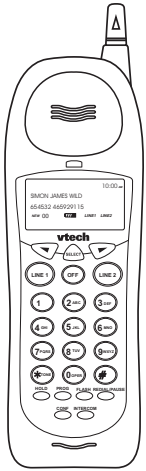

HANDSET

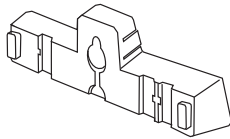

WALL MOUNTING BRACKET

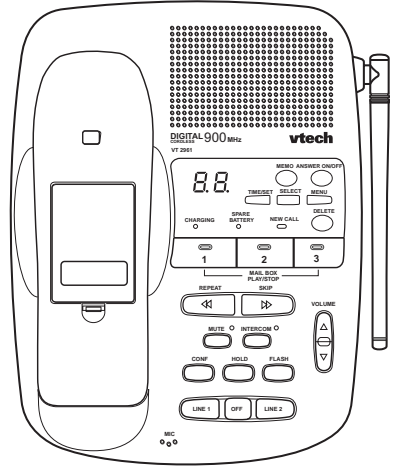

BASE UNIT

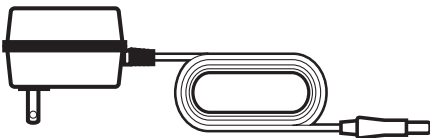

AC POWER ADAPTOR

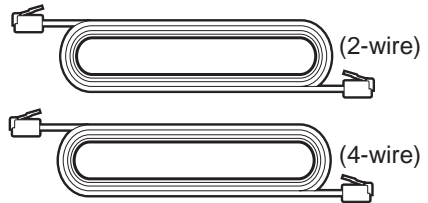

TELEPHONE LINE CORDS

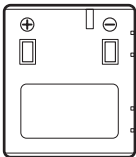

BATTERY PACK



SHORT TELEPHONE LINE CORD

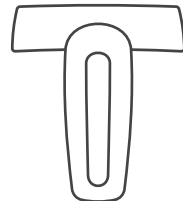

BELT-CLIP

IMPORTANT SAFETY INSTRUCTIONS

When using your telephone equipment, basic safety precautions should always be followed to reduce the risk of fire, electric shock and injury to persons, including the following:

1. Read and understand all instructions.
2. Follow all warnings and instructions marked on the product.
3. Unplug this product from the wall outlet before cleaning. Do not use liquid cleaners or aerosol cleaners. Use a dry cloth for cleaning.
4. Do not use this product near water, for example, near a bath tub, wash bowl, kitchen sink, or laundry tub, in a wet basement, or near a swimming pool.
5. Do not place this product on unstable cart, stand, or table. The telephone may fall, causing serious damage to the telephone.
6. Slots and openings in the cabinet and the back or bottom are provided for ventilation, to protect it from overheating, these openings must not be blocked or covered. The openings should never be blocked by placing the product on the bed, sofa, rug, or other similar surface. This product should never be placed near or over a radiator or heat register. This product should not be placed in a built-in installation unless proper ventilation is provided.
7. This product should be operated only from the type of power source indicated on the marking label. If you are not sure of the type of power supply to your home, consult your dealer or local power company.
8. Do not allow anything to rest on the power cord. Do not locate this product where the cord will be abused by persons walking on it.
9. Do not overload wall outlets and extension cords as this can result in the risk of fire or electric shock.
10. Never push objects of any kind into this product through cabinet slots as they may touch dangerous voltage points or short out parts that could result in a risk of fire or electric shock. Never spill liquid of any kind on the product.
11. To reduce the risk of electric shock, do not disassemble this product, but take it to a qualified service personnel when some service or repair work is required. Opening or removing covers may expose you to dangerous voltages or other risks. Incorrect reassembly can cause electric shock when the appliance is subsequently used.
12. Unplug this product from the wall outlet and refer servicing to qualified service personnel under the following conditions:
 - A. When the power supply cord plug is damaged or frayed.
 - B. If liquid has been spilled into the product.
 - C. If the product has been exposed to rain or water.

IMPORTANT SAFETY INSTRUCTIONS

- D. If the product does not operate normally by following the operating instructions. Adjust only those controls, that are covered by the operating instructions because improper adjustment of other controls may result in damage and will often require extensive work by a qualified technician to restore the product to normal operation.
 - E. If the product has been dropped or the cabinet has been damaged.
 - F. If the product exhibits a distinct change in performance.
13. Do not use the telephone to report a gas leak in the vicinity of the leak.

CAUTION: TO REDUCE THE RISK OF FIRE OR INJURY, READ AND FOLLOW THESE INSTRUCTIONS.

1. Use only the appropriate type and size battery pack specified in the instruction manual provided for this product.
2. Do not dispose of the battery pack in a fire. The cell may explode. Check with State and local codes for possible special disposal instructions.
3. Do not open or mutilate the battery pack. Released electrolyte is corrosive and may cause damage to the eyes or skin. It may be toxic if swallowed.
4. Exercise care in handling battery in order not to short the battery with conducting materials such as rings, bracelets, and keys. The battery or conductor may overheat and cause burns.
5. Charge the battery pack provided with or identified for use with this product only in accordance with the instructions and limitations specified in the instruction manual.
6. Observe proper polarity orientation between the battery pack and battery charger.

SAVE THESE INSTRUCTIONS

SETTING UP YOUR VT2961

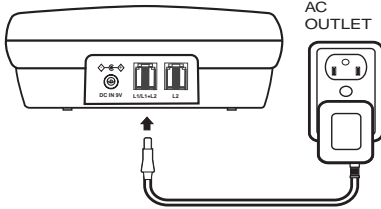

1. Plug the **AC POWER ADAPTER** into a live electrical outlet and the **DC POWER CONNECTOR** into the back of the Base Unit.

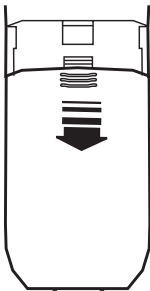

PRESS and SLIDE
DOWNWARD

2. Slide the Handset battery cover down, and remove it from the Handset.

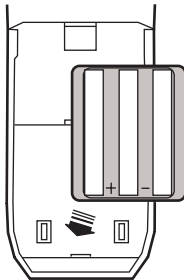

PLACE THE NEW
BATTERY PACK
INTO THE
BATTERY
COMPARTMENT

PLEASE NOTE THE
CORRECT POSITION
OF THE BATTERY
PACK WHEN
INSTALLING

3. Install the BATTERY PACK, with the metal contacts facing down and aligned with the Handset contacts. Replace Handset battery cover.

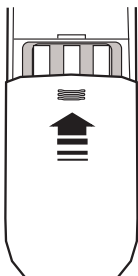

SLIDE IN THE
BATTERY
COVER

4. Place the Handset into the Base Unit cradle. Make sure the Charging light is illuminated. **Charge for at least 16 hours before first using the phone.** The Handset can charge face up or down.

5. Set the **TONE/PULSE** switch, located on

SETTING UP YOUR VT2961

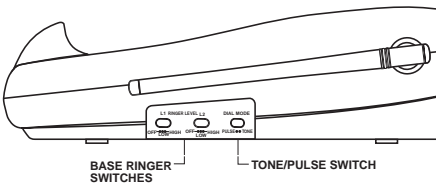

the antenna side of the Base Unit, to the desired dialing mode. In most areas, **TONE** is the desired mode.

6. After charging the battery pack, connect the telephone line(s)

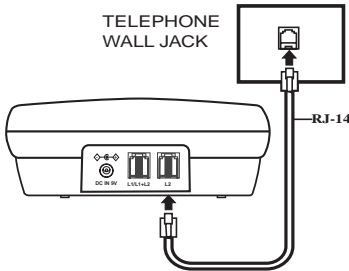

1. If you have 2 lines coming out of a single wall jack:

Connect a 4-wire (RJ-14) phone cord between the wall jack and the phone jack labeled **L1 / L1+L2**.

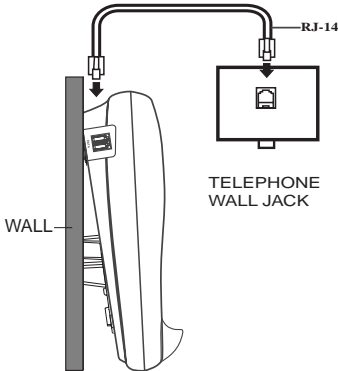

If you are wall mounting your Base Unit, a short, 4-wire phone is provided for your convenience

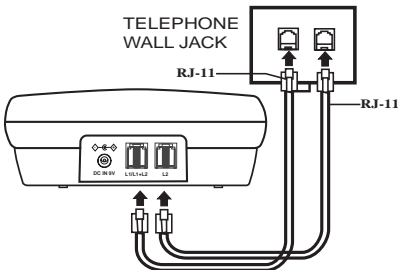

2. If you have 2 lines, each coming out of a separate wall jack:

Connect a phone cord from the wall jack you wish to designate as your **LINE1**, to the **L1 / L1+L2** jack on the back of the phone; next, connect a phone cord from the remaining wall jack to the **L2** jack on the phone.

NOTE: You can use your **VT2931** as a one-line phone, as well. For best results, raise the antenna on the Handset and Base Unit when using your telephone.

THE RBRC™ SEAL



The RBRC® Seal on the nickel-cadmium battery contained in our product indicates that VTech Communications, Inc. is voluntarily participating in an industry program to collect and recycle these batteries at the end of their useful lives, when taken out of service within the United States and Canada.

The RBRC® program provides a convenient alternative to placing used nickel-cadmium batteries into the trash or municipal waste, which may be illegal in your area.

VTech's participation in RBRC® makes it easy for you to drop off the spent battery at local retailers participating in the RBRC® program or at authorized VTech product service centers. Please call **1-800-8-BATTERY™** for information on Ni-Cd battery recycling and disposal bans/restrictions in your area. VTech's involvement in this program is part of its commitment to protecting our environment and conserving natural resources.

Remove the nickel-cadmium battery pack by pressing on the Handset battery cover and sliding downward.

RBRC® is a registered trademark of Rechargeable Battery Recycling Corporation.

WALL MOUNTING

The Wall Mounting bracket is designed to fit on standard Wall Mounting plates.

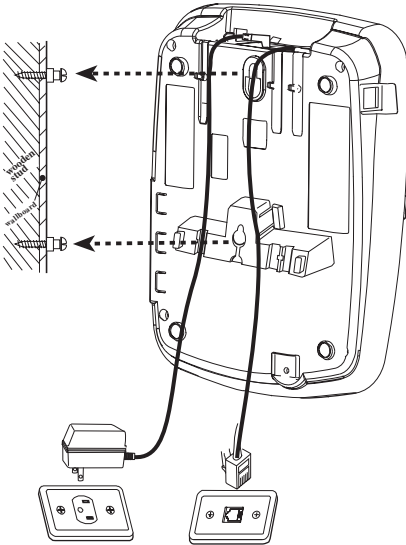

1. Choose a spot near an electrical outlet and a telephone jack.

Your phone requires a modular telephone jack and a standard electrical outlet (120v AC). The power cord is six feet long; make sure there is an electrical outlet within reach of the Base Unit. The outlet should not be controlled by a wall switch. If the switch is ever turned off, the phone will not operate.

2. Position the wall mount bracket on the base.

Line up the tabs on the wall mounting bracket with the holes on the bottom of the base. Snap the wall mounting bracket firmly into place.

3. Mount the base on the wall.

Position the base so the mounting studs will fit into the holes on the bottom of the base. Position the power cord to extend down the wall. Slide the base down on the mounting studs until it locks into place.

4. Connect the telephone line cord(s).

Insert one end of the telephone line cord(s) into the appropriate jacks on the back of the Base Unit, and the other end into the wall jack(s). For your convenience, a short line cord is provided.

5. Plug the AC adapter into an electrical outlet and the DC connector into the power jack located on the back of the Base Unit.

HANDSET UNIT KEY AND FEATURES

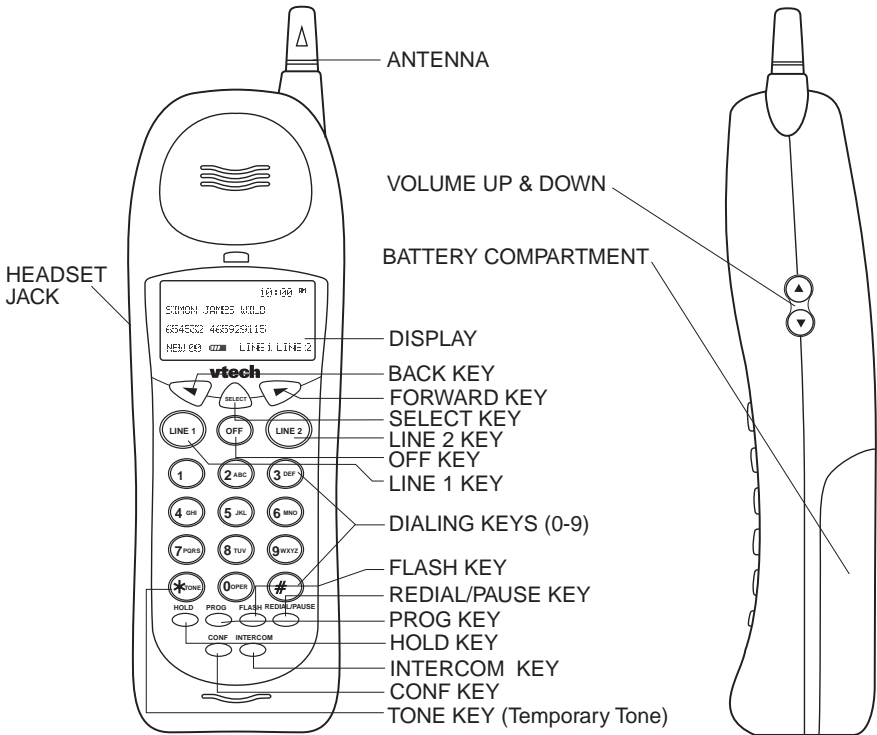

BASE UNIT KEYS AND FEATURES

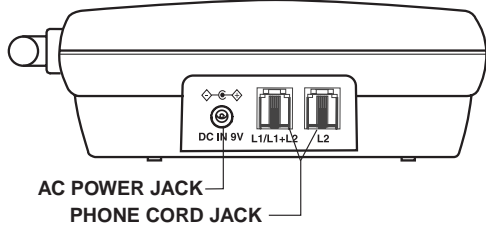
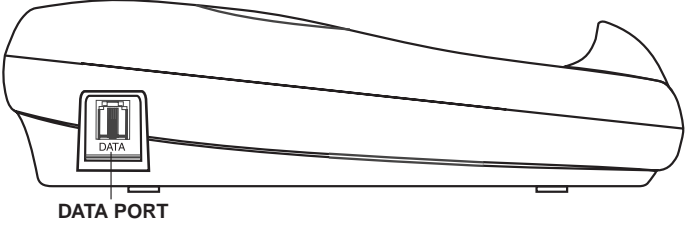
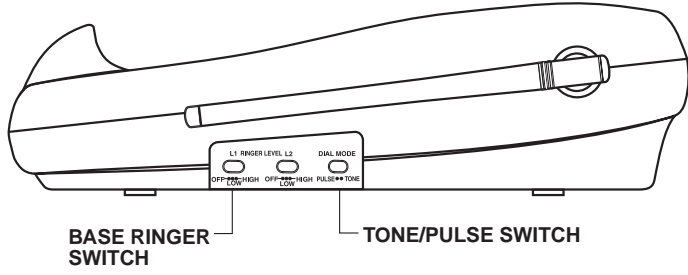
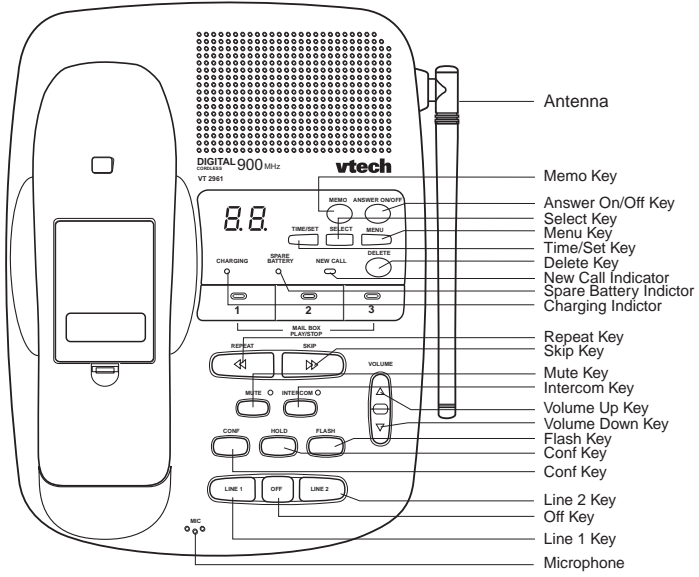



BASIC OPERATIONS

AREA CODE PROGRAMMING

To benefit from all the Caller ID features of your telephone, you must enter your home area code.



If you live in an area where you dial calls within your own area code by dialing 7 digits (no area code), follow these steps (with the Handset **OFF**):

1. Press **PROG.**
2. Press  until **AREA** is blinking.
3. Press **SELECT.**
4. **HOME** should be blinking. If not, press  until it blinks.
5. Press **SELECT.** **ENTER AREA CODE** is displayed.
6. Enter your **own home area code.**
7. Press **SELECT.**



KEY BEEPS

Your Handset keys emit a beep as you press them. If you do not want to hear the beep, do the following while the Handset is not in use (on hook):

1. Press **PROG.**
2. Press  until **KEYBEEPS** is flashing.
3. Press **SELECT.**
4. Press  until **OFF** is flashing.
5. Press **SELECT.**



DIRECTORY AREA
RINGER 





KEYBEEPS
ON- 

To turn the keybeep feature ON again, repeat steps 1 to 3 at the fourth step, press  until ON is flashing, then press **SELECT.**



ALTERNATIVE METHOD

If you live in an area where all local calls require 10 digits (area code plus phone number, without dialing "1" first):

1. Press **PROG.**
2. Press  until **AREA** is blinking.
3. Press **SELECT.**
4. **HOME** should be blinking. If not, press  until it blinks.
5. Press **SELECT.** **ENTER AREA CODE** is displayed.
6. Enter **000.**
7. Press **SELECT** and continue below.

BASIC OPERATIONS

You may program up to **5** local area codes. An area code is “local” if you do not dial “1” when you make calls to that area code. In other words, you make calls to “local” area codes by dialing 10 digits (area code plus phone number) without a preceding “1”. This might include your own area code

1. Press **PROG.**
2. Press  until **AREA** is blinking.
3. Press **SELECT.**
4. Press  until **LOCAL** is blinking.
Press **SELECT.**
5. Press  until the desired location is blinking (**#1.....#5**).
6. Press **SELECT**. **ENTER AREA CODE** is displayed.
7. Enter a “local” area code.
8. Press **SELECT.**
9. Press **OFF** when finished.

NOTE: To replace or edit an existing area code, use the  key to delete the existing digits, and enter the desired area code. Press **SELECT** when done.

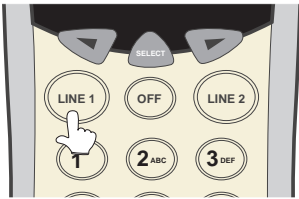

MAKING CALLS

From the Handset: Press desired **LINE** key and listen for dial tone. Dial the phone number. The Base Unit will display **HANDSET IN USE**, and the corresponding **LINE** key will blink. Press **OFF** to end your call.

Alternative Method

1. Dial the phone number, checking the display for accuracy. If you make a mistake, use the  key to backspace.
2. Once you have entered the phone number, press the desired **LINE** key.
3. Press **OFF** to end your call.

SPEAKERPHONE TIPS

If you use your Speakerphone in a noisy environment, the other person’s voice may fade out. In this case, try eliminating the environmental noise (a television or radio playing, for example). Otherwise, press **MUTE** while the other person is speaking. Before you start to talk, press **MUTE** again so the other person can hear you.

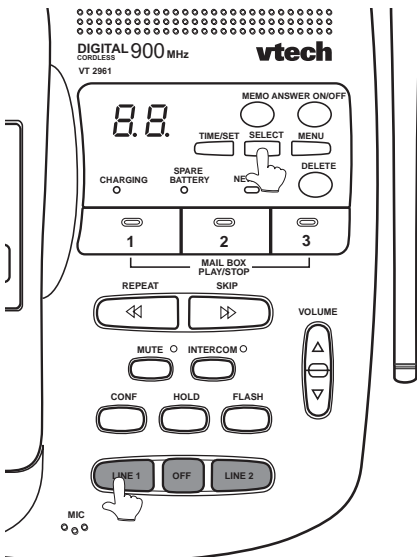

BASIC OPERATIONS

REDIAL/PAUSE

From the Handset: Your VT 2931 Handset remembers the last 5 phone number you dialed. With the Handset off, press **REDIAL/PAUSE**. The Handset will display:



This is the last phone number dialed from the Handset. Press ◀ or ▶ to scroll through the previous numbers dialed. Once the desired number is displayed on the Handset, press the appropriate **LINE** key to dial.

ANSWERING CALLS

From the Handset: 1. Press the flashing **LINE** key . The **LINE** key will glow steadily and the Handset will display:



2. The Base Unit will display **HANDSET IN USE**, and the corresponding **LINE** key will blink.

3. Press **OFF** to end your call.



From the Base: 1. Press the flashing **LINE** key. The **LINE** key will glow steadily and the Base Unit will display:

2. The corresponding **LINE** key on the Handset will blink while the Speakerphone is in use.

3. Press **OFF** to end your call.



HANDSET VOLUME

Adjust the Handset volume with the ▲ and ▼ keys, located on the side of the Handset.

The Handset will display the relative volume level as you adjust it.

SPEAKERPHONE VOLUME

Adjust the Base Unit volume with the ▲ and ▼ keys, located to the right of the dialpad. The Base will display the relative volume level as you adjust it. The Speakerphone volume can only be adjusted while the Base Unit is **IN USE** (in Speakerphone or Intercom mode).

CALL TIMER

While the Handset or Base is on a call, the corresponding display will show the approximate duration of that call. This is very helpful in monitoring long distance expenses.

HOLD

To place a call on hold, press **HOLD** on the Handset or Base, whichever you are using. **HOLD** will be displayed on the corresponding screen.

To return to your call, press the appropriate **LINE** key.

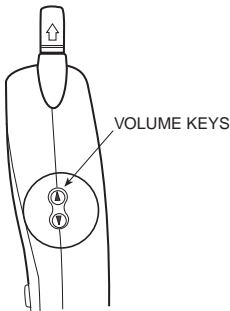

BASIC OPERATIONS

CALL WAITING

If you subscribe to Call Waiting, you will hear a tone while on the phone as you receive a second call. If you subscribe to Caller ID on Call Waiting, the Handset (or Base) will display who the second caller is before you answer.

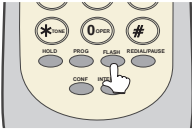

To answer Call Waiting, press **FLASH**. To return to your original call, press **FLASH** again. This procedure is the same for Handset and Speakerphone calls.

PAGING THE HANDSET

- To make the Handset ring, press **INTERCOM** on the Base.
- To stop the ringing, press **OFF** on the Handset, or Base Unit.

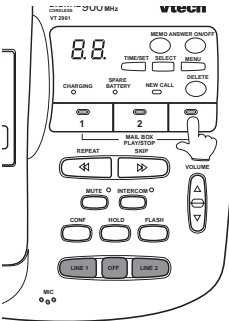

INTERCOM

(Conversation between the Base and Handset)

From the Handset:

Press **INTERCOM**.

The Base Unit will ring, and the intercom call will be *automatically* connected.

From the Base:

1. Press **INTERCOM**.
2. The Handset will ring. The Base Unit and Handset will display:



3. To answer the call, press **INTERCOM** on the Handset.
4. To end an Intercom call, press **OFF** on either the Handset or the Base.

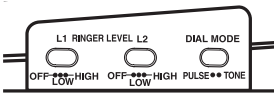

BASE UNIT RINGER

The Base Unit ringer is controlled by switches located in the right edge of the Base full stop Each line can be set to OFF, LOW, or HIGH volume.

SETTING THE HANDSET RINGER

1. Press **PROG** on the Handset.
2. Press **#**.
3. Press **SELECT**.
4. Press **1** or **2** to select **LINE1** or **LINE2**.
5. Press **SELECT**.



BASIC OPERATIONS

CONFERENCE CALLING

To talk to both lines at the same time:

1. While you are on one line, press **HOLD**.
2. Make or receive a call on the available line.
3. Press **CONF**. You are now talking to both lines.
4. To end your conference call, press **OFF**.

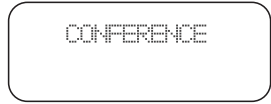

The procedure is the same for the Handset and Base. Whichever you are using, **CONFERENCE** is displayed on the screen.

To place both lines on hold, press **HOLD**. Press **CONF** to return to the conference call. To switch from Handset to Base (or vice versa), press **HOLD** on whichever component you're using, then **CONF** on the other.

NOTE: Both the Handset and Base can join in the Conference call.

CALLER ID

This telephone provides two types of Caller ID on both the Handset and the Base Unit:

Caller ID: Displays the name and number of each caller after the phone begins ringing (requires Caller ID service from your telephone company).

Caller ID on Call Waiting: Shows the name and number of each caller on Call Waiting after you hear the Call Waiting tone (requires Caller ID on Call Waiting service).





A **NEW CALL** light will flash on the Base Unit to alert you to new CID records. Once the new caller ID records have been reviewed on the Handset, the NEW CALL light will go out.

NOTE: Caller ID and Call Waiting Caller ID are subscription services, available through most local phone service providers. You must subscribe to these services to benefit from the Caller ID features of this phone. Contact your local phone company for details.

The phone has a Call Log, which stores the name, number, date, and time of the last 50 calls received. You can review the Call Log to see who called while you were out. You can speed-dial numbers from the Call Log. And you can store names and numbers from the Call Log into your directory.

REVIEWING THE CALL LOG

With the Handset OFF:

1. Press  or . You will see the number of NEW (not viewed) and OLD (previously viewed) calls.
2. Continue to press  or  to review the callers.

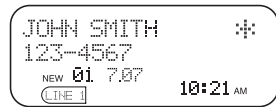



Some locations are not equipped to send Caller ID information when a person places a call. When you receive calls from such locations, your phone will display **UNAVAILABLE**.

If a caller purposely blocks their phone number from being delivered by Caller ID, your phone will display **PRIVATE**.





HINT: If a * follows the phone number it indicates the party has called more than once.

ERASING CALLS

To erase a call; with the Handset OFF:

- Press  or  until you see the call you want to erase.
- Press **SELECT**.
- Press  until **ERASE** is blinking. Press **SELECT**.
- Press  until **YES** is blinking. Then press **SELECT**.

To erase your entire Call Log; after you have viewed all calls and the handset is off:

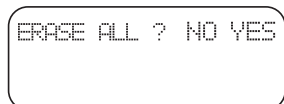

- Press  or  until you see any call in the log.
- Press **SELECT**.
- Press  until **ERASE** is blinking. Press **SELECT**.
- Press  until **ALL** is blinking. Then press **SELECT**.
The handset displays:
- Press  until **YES** is blinking. Then press **SELECT**.



DIRECTORY

SPEED DIALING FROM CALLER ID

With the Handset OFF:

- Press  or  until you see the desired caller.
- Press the desired line key. You will hear a dial tone, and the number will be dialed automatically.

TO STORE A NAME AND NUMBER

1. Press **PROG**. **DIRECTORY** will be blinking.
2. Press **SELECT**.
3. The screen will display **ENTER NAME**.

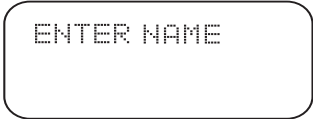

4. Use the Dialing keys to enter the desired name. Press the key until the desired letter or character appears. A guide to the characters:

<u>KEY</u>	<u>CHARACTERS</u>
1	1
2	A>B>C>2
3	D>E>F>3
4	G>H>I>4
5	J>K>L>5
6	M>N>O>6
7	P>Q>R>S>7
8	T>U>V>8
9	W>X>Y>Z>9
0	0
*	*
#	& ' , - . #

If consecutive characters are found on the same key (*D* and *E*, for example), you'll need to press  to advance to the next space. For example, to enter the name **DEAN**:

- Press **3** (*D*)
- Press 
- Press **3 twice** (*E*)
- Press **2** (*A*)
- Press **6 twice** (*N*)

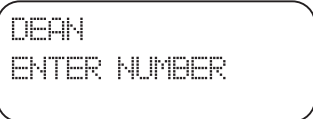

5. When the name is complete, press **SELECT**. The screen will display:

6. Enter the phone number. Press **REDIAL/PAUSE** if you need to enter a 2-second pause in the dialing sequence. (For example, you might store a voice mail access number, pause, password.)

7. When the phone number is complete, press **SELECT**.

DIRECTORY

STORING A CALLER ID RECORD IN THE DIRECTORY

With the Handset **OFF**:

1. Press or until you see the desired call.
2. Press **SELECT** .
3. Press until **PGM** is blinking.
4. Press **SELECT** .



If you want to edit the name, press to erase letters. Use the dialpad to enter new letters. When the name is correct, press **SELECT**.

If you want to edit the number, press to erase digits. Use the dialpad to enter new digits. When the number is correct, press **SELECT**.

You will then hear a long beep. The name and number have been stored in the Directory.

MAKING DIRECTORY CALLS

- Press **SELECT**. **DIRECTORY** will appear.
- Press or to scroll to the desired name; *or*,
- Search by entering the first letter of the name, and then press or if necessary.
- Press the desired **LINE** key. You will hear a dial tone, and the number will be dialed.

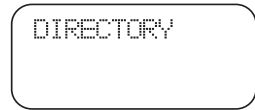

EDITING A DIRECTORY ENTRY

- Press **SELECT** . The Handset says **DIRECTORY**.
- Press or to scroll to the desired name; *or*,
- Search by entering the first letter of the name, and then press or if necessary.
- Press **SELECT** .
- Press until **EDIT** is blinking.
- Press **SELECT** .The name appears.
- If you want to edit the name, press to erase letters. Use the dialpad to enter new letters. When the name is correct, press **SELECT**.
- The number appears. If you want to edit the number, press to erase digits. Use the dialpad to enter new digits. When the number is correct, press **SELECT**.



ERASING A DIRECTORY ENTRY

- Press **SELECT**.
- Press or to scroll to the desired name; *or*,
- Search by entering the first letter of the name, and then press or if necessary.
- Press **SELECT** .
- Press until **ERASE** is blinking.
- Press **SELECT**. Press until **YES** is blinking.
- Press **SELECT**.

BASE UNIT OPERATION

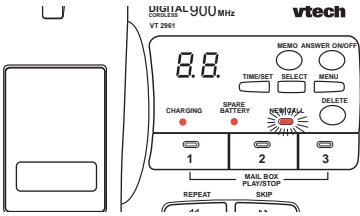

CHARGING: illuminates when the Handset is cradled.

SPARE BATTERY: illuminates when a battery Pack is charging in the Base Unit charger.

NEW CALL: flashes when new Caller ID records have been received.

MESSAGE: flashes when new Voice Mail messages are present.

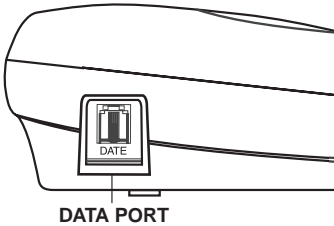

DATA PORT

Your **VT 2961** has a Data Port on the left-hand edge of the Base Unit. This port provides an easy way to connect your fax machine, laptop computer, modem, or other telephone device for direct access to **LINE2**.

The Data Port only provides access to Line 2, so you must have an active line connected to the **LINE2** input on the back of the **VT 2961**.

Connect an RJ-11(2-element) phone cord from the Data Port to you fax, laptop,etc.

NOTE: While the Data Port is in use, accidental use of Line 2 by a parallel phone, the **VT 2961** Handset, or a Call Waiting ID alert may in interrupt the data transmission.

HEADSET OPERATIONS

Your **VTech** cordless phone is equipped with a 2.5mm headset Jack for use with an optional accessory Headset for hands-free operation.

If you choose to use the Headset option, you must obtain an optional accessory Headset, which is compatible with the **VTech** cordless phone.

To purchase a Headset, call VTech Customer Service at 1-800-595-9511.
In Canada, call **VTECH** Electronics at 1-800-267-7377.

Once you have a compatible 2.5mm Headset, locate the Headset Jack on the **VTech** cordless phone Handset. Connect the plug on the Headset cord to the jack on the cordless Handset. The plug should fit securely. Do not force the connection.

OPERATION

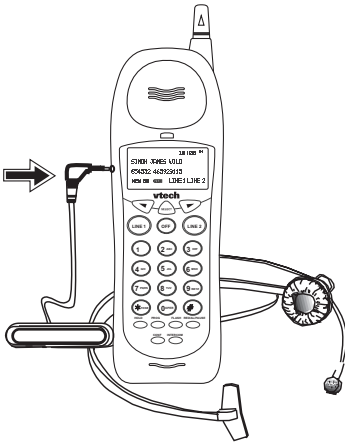

NOTE: Whenever a compatible Headset is connected to the cordless Handset, the microphone on the Handset will be muted. This is done to limit the effect of background noise.

The following operational characteristics also apply to other headsets which are not sold by **VTech**; however, **VTech** assumes no responsibility for their performance.

The **VTech** compatible Headset has a reversible, monaural design. You can wear you Headset on either ear, leaving one ear free for room conversation.

The headband can be adjusted to fit the contour of you head. Using both hands, slide the headband up or down so that it rests comfortably on your head, with the speaker cushion centered against your ear.

For maximum sound quality, the flexible microphone should be positioned at the corner of your mouth, about one inch from your face.

BELT CLIP

The **VTech** cordless phone is also equipped with a detachable belt clip. Align the pins on the inside edge of the clip with the notches on the sides of the **VTech** cordless phone Handset. The belt clip should snap securely into place. Do not force the connection.

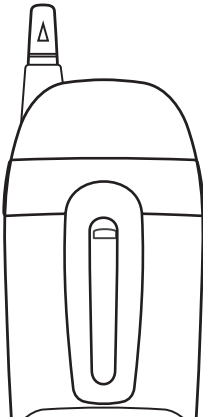

ANSWERING SYSTEM SETUP

Answering System Program-ming Overview

Setup order for the Answering System is:

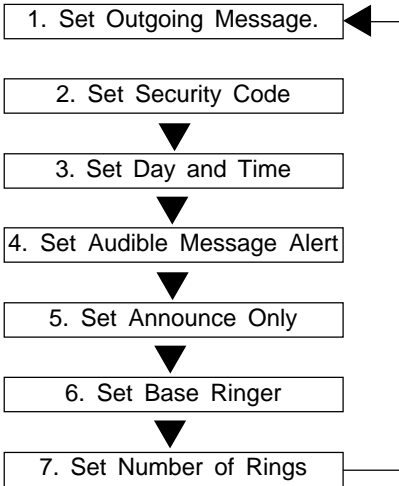

During Answering System setup, the display will flash " -- ". If no key is pressed for 20 seconds, the Answering System will beep, and exit program mode. You can also exit program mode at any time by pressing any **MAILBOX** key.

Set Outgoing Message (OGM)

Selecting Announcement

There are 2 choices of announcements:

Normal outgoing message & Outgoing message for Announce Only.

1. Normal answering mode.(Announce Only:OFF)

In this mode, the caller is able to leave his message. If no announcement is recorded, the default announcement *"Hello, I'm unable to answer your call right now. Please leave your name, number and message after the tone."* will be used. (see **Recording the OGM**).

2. Announce Only mode

If this mode is set, the caller is not able to leave his message. If no announcement is recorded, the factory default greeting is: *"Hello, I'm unable to answer your call right now. Please call again.Thank you."* will be used.(see **Recording the OGM**)

Example for OGM1 (for multi - user application):

"Hi! We can't come to the phone right now. If you have a message for John press 1 ('Star 1'), for Jane press 2 ('Star 2'), for Jack press 3 ('Star 3'). Or, just stay on the line and record after the beep. Thank you."

Example for OGM2 (Announce Only):

"Hi! You have reached Jack and Jill. We will be back after 1 p.m. Please call back then. Thank you."

ANSWERING SYSTEM SETUP

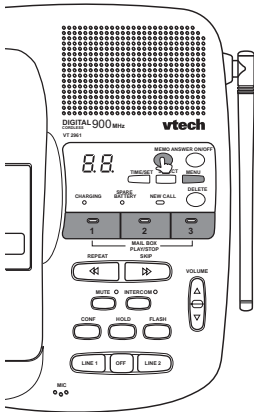

Recording Your OGM

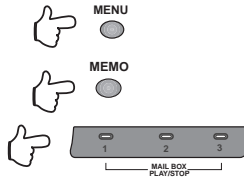

NOTE:

In Announce Only mode, your outgoing announcement is repeated before hanging up.

Recording / Playing / Deleting the Outgoing Messages (OGM)

1. Press **MENU** key until the desired item (Set Outgoing Message) is announced.
2. Press **MEMO**. "Now recording", is announced, followed by a beep. Speak towards the front of the Answering System (max. length: 90 seconds).

3. Press any **MAILBOX** key to stop the recording.
4. Then OGM replays the message automatically, followed by a beep.
5. To review a recorded announcement, press **MENU** key until "Set Outgoing Message" is announced. Press any **MAILBOX** key. The current greeting is played.
6. To delete a recorded announcement, press **DELETE** during OGM playback. You then hear "Outgoing Message has been erased".

NOTE:

If your recording time is less than 2 seconds, your OGM will not be recorded, and the default greeting will be used.

Set Security Code

The security code programmed into the Answering System is used to gain access to functions from remote locations. The security code default setting is **19**.

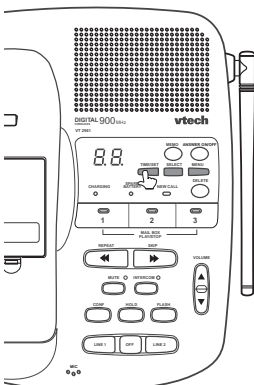

Set Security Code

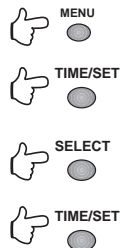

1. Press **MENU** unit you hear "Set security code."
2. Press **TIME/SET** to hear the current security code.
3. Press **SELECT** briefly to increase the security code by 1. Or, hold **SELECT** continuously to increase the code by multiples of 10.
4. Press **TIME/SET** to confirm your choice and you will hear the announcement of the security code.

ANSWERING SYSTEM SETUP

Day and Time

During initial setup, or after a power failure, the day and time default is set to Monday, 12:00am. The display will flash "CL" to indicate day and time need to be set.

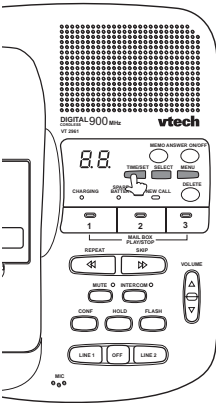

Set Day & Time



1. Press **MENU** until you hear, "Set day and time."
2. Press **SELECT** until the correct day is announced.
3. Press **TIME/SET** to confirm your choice.
4. Press **SELECT** until the correct hour is announced.
5. Press **TIME/SET** to confirm your choice.
6. Press **SELECT** until the correct minute is announced. Holding the key continuously will increase the minutes by 10 minute steps.
7. Press **TIME/SET** to confirm your choice. You will hear an announcement of the day and time.

Set Audible Message Alert

If you want your Answering System to beep once every 10 seconds to notify you when new messages have been received, set Audible Message Alert to ON. Otherwise, it is preset to OFF.

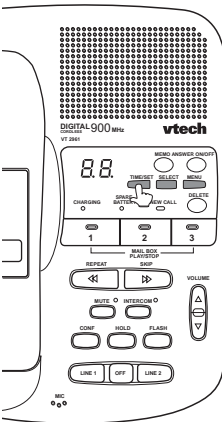

Set Audible Message Alert

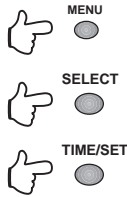

1. Press **MENU** until you hear "Set Audible Message Alert."
2. Press **SELECT** until the desired setting, (ON or OFF) is announced.
3. Press **TIME/SET** to confirm your choice. The voice prompt of "Audible Message Alert On" or "Audible Message Alert Off" will be heard.

ANSWERING SYSTEM SETUP

Set Announce Only

CAUTION:

If you turn on the Announce Only option, your callers cannot leave a message.

1. Press **MENU** until "Set Announce Only" is announced.
2. Press **SELECT** until desired setting "ON" or "OFF" is declared.
3. Press **TIME/SET** to confirm, and the setting will be announced.

Note: You can store one OGM for Announce Only mode, and a separate OGM for Normal (accept messages) mode. The appropriate OGM will be played based on how you set Announce Only.

Set Call Screening

Call Screening allows you to hear incoming messages at the Base Unit as they are being recorded. If you want to answer the call at once, just press the Handset or an extension phone, and the Answering System will stop recording.

1. Press MENU until you hear "Set Call Screening"
2. Press SELECT to toggle between ON and OFF.
3. Press TIME/SET to confirm your selection. " Call Screening is ON (or OFF) will be announced.

Set Number of Rings

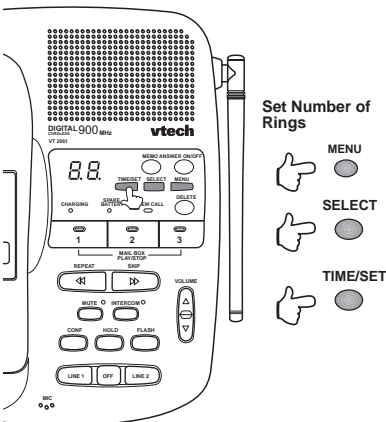

The Answering System has 4 ring type settings:

2 rings The incoming call is answered after 2 rings.

4 rings The incoming call is answered after 4 rings.

6 rings The incoming call is answered after 6 rings.

Toll Saver
The incoming call is answered after 2 rings only if there are new messages/memos present. Otherwise, the call is answered after 4 rings. This may help you avoid long distance charges when retrieving messages remotely.

1. Press **MENU** until you hear "Set number of rings."
2. Press **SELECT** until you hear the desired setting "2", "4", "6", or "Toll Saver".
3. Press **TIME/SET** to confirm your choice. The selected setting is then announced.

ANSWERING SYSTEM OPERATIONS

Leaving a Message (Incoming Message)

The Answering System will answer a call (according to the current ring selection), then play the OGM, followed by a beep to signal the start of recording.

- Default mailbox is MAILBOX 1.
- If you want to record the incoming message in specific mailbox, press " *x" (*1, *2 or *3) during OGM playback.
- After desired mailbox is selected, "Mailbox X, now recording" will be announced, and incoming message recording starts after a beep.
- If incoming message length is less than 2 seconds, message will not be recorded.

Listening to Messages / Memos

When new messages and/or new memos are left, the display will flash the total number of new messages in all mailboxes.

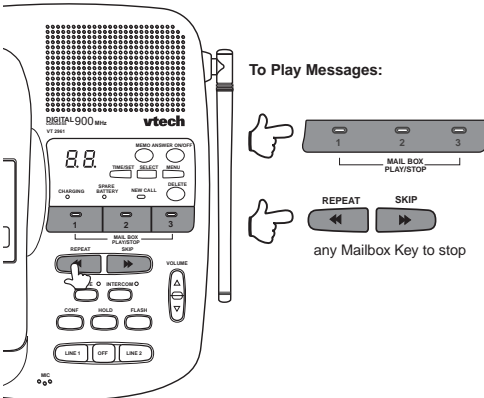

- Press the desired Mailbox key to hear messages.
- The system will announce "Mailbox X, you have x new message(s) and x old message(s)" in the presence of new message in corresponding mailbox. Then the system will play only the new messages.
- In the absence of new messages, the system will announce "Mailbox x, you have x old messages" and then playback the old messages.
- The ►► and ◀◀ keys can be used to skip forward and backward during message playback.
- To stop message playback, and return to normal operation mode, press any MAILBOX key.

- The day and time stamp is announced after each message is played.
- After all messages and memos have been played, the final voice prompt will be, "End of messages", and the Answering System will exit playback mode.
- Note that the system will play the message based on "First-In-First-Out"
- If the system has less than 5 minutes recording time left, it will announce the remaining recording time to alert the user.
- During message playback, the display will be flashing to indicate that the currently playing message is a new message.

Saving Messages

- The Answering System will automatically save your messages if you do not delete them. The messages will be retained even after power failure.
- The system can record up to 15 minutes of messages.

ANSWERING SYSTEM OPERATIONS

Deleting Messages

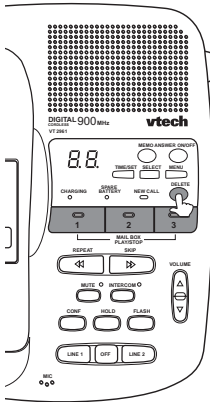

Deleting Messages:

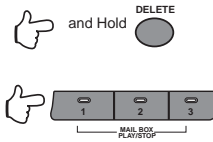

- Press **DELETE** at any time during message playback to delete the current message.
- All old messages for a particular mailbox, can be deleted by pressing and holding the **DELETE** key for more than 2 seconds. The system will announce "Please select mailbox".
- Press the **Mailbox X** key to delete all the old messages in the selected mailbox.

NOTE:

The DELETE function will only delete old messages. New messages CANNOT be deleted until they are reviewed.

Turning the Answering Machine ON/OFF

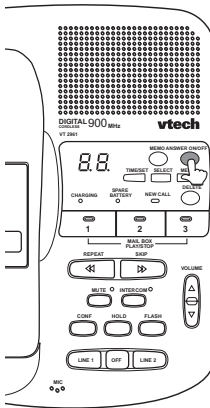

Turning Answering System ON/OFF

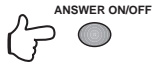

- If you want the Answering System to answer calls, press **ANSWER ON/OFF**. The **ON** LED will then be turned on, and "Answering machine on" will be announced.
- If you don't want the Answering System operations to answer calls, press **ANSWER ON/OFF**. The **ON** LED will then be turned off and "Answering machine off" will be announced.
- The display will still show the number for new messages.
- Even if the Answering System is set to OFF, it will still answer calls after 10 rings. An announcement, "Please enter your security code" is given, and you can enter your security code to use remote operation. (See **Remote Operation of Answering System**)

ANSWERING SYSTEM OPERATIONS

Check Current Day and Time

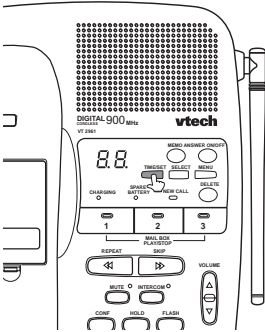

Check Day and Time



You can check the current day and time by pressing **TIME/SET**. After the announcement, the Answering System will generate a beep.

Changing Speaker Volume

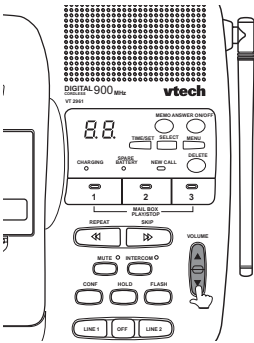

Adjusting Volume



- Press the ▲ and ▼ keys for the desired volume level. There are 8 volume levels.
- If volume is set at maximum or minimum level, Further pressing of the volume keys will give 3 short beep tones.
- Volume changes automatically continues if the volume UP/DOWN is held.

Changing Playback Speed

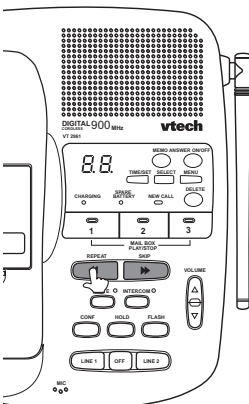

Adjusting Playback Speed

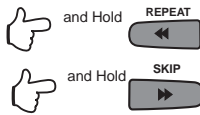

During playback, you can change the playback speed by simply holding down ◀◀ (SLOW) or ▶▶ (QUICK) to the desired speed during playback. There are 3 playback speeds (SLOW/NORMAL/QUICK). The default speed is normal. Playback speed will return to normal once you exit the playback mode.

ANSWERING SYSTEM OPERATIONS

Auto Disconnect for Extension Phone Pick-up

The Answering System will auto-disconnect the telephone line if an extension phone or the cordless Handset accesses the line.

Memory Full

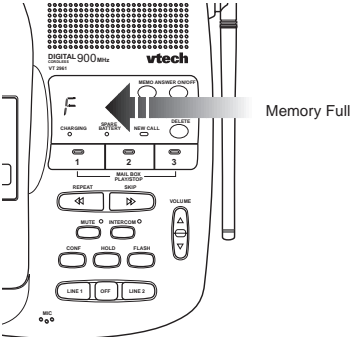

- When the Answering System has less than 30 seconds recording time remaining, or the total number of messages equal 99, the display shows "F" with the number of new messages to indicate memory full.
- If the Answering System memory is full, it will automatically default to Answering System OFF mode. The Answering System will answer a call after 10 rings and "Memory full, Please enter your security code" is announced. You may enter remote operation mode by entering the security code.
- If memory is full, any attempt to record memos or OGM's will be ignored.

Power Failure

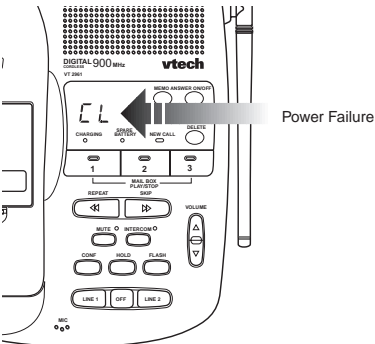

- After a power failure, "CL" will flash to notify you to set the day and time.
- All the messages, OGM's and menu settings (other than day and time) will be retained.
- The Answering System will default to ANSWER ON.
- Note that after power up, the Answering System may have an initialization period, during which, the display will flash with "--". During this period, you can still use the cordless phone.

ANSWERING SYSTEM OPERATIONS

BASE UNIT MESSAGE WINDOW (LED)

- The large Base Unit LED provides useful data on the status of your VT 2961 answering device. Below are examples of the LED data:

The LED displays:	What it means
Flashing number	You have that amount of new messages
0	You have no new messages
CL flashing	he clock needs to be set
A	Answering System is in Announce-Only mode
F flashing	Answering System memory is full
99 flashing	Recording time has exceeded 99 seconds
1-8	Volume level as you're setting it.
--	Answering System is answering a call or in remote mode
-- flashing	Answering System is in programming mode

REMOTE OPERATION OF ANSWERING SYSTEM

Remote operation allows you to control the functions of the Answering System when you are away from the Base, and call from an outside telephone line. The Answering System cannot be accessed from another telephone on the same line. You can access many of the Answering System functions from a remote location, such as listening to messages, changing recorded announcements, and recording memos.

Remote operation can only be accessed from a touch tone telephone. If the remote phone is set to pulse dialing, switch it to tone. If tone dialing is not available, you will not be able to access the Answering System.

Note: All function codes should be entered within 2 seconds in order to activate Remote Operation.

To Activate Remote Operation From a Different Telephone Line

1. If the Answering System is **OFF**, you can dial your telephone number and wait for the Answering System to answer your call after 10 rings. An announcement, "Please enter your security code" is given, and you enter your security code to use remote operation.
2. If the Answering System is **ON**, it will answer your call and begin playing the currently selected announcement (as with any incoming call).
3. Enter **#** followed by your 2 digit security code during the announcement. The default security code is 19.
4. Once the security code is received, a double confirmation beep will be given, and you are in Remote Operation mode. You can then control the Answering Machine functions using the telephone keypad.
5. The user can also enter the Remote Operation mode during message recording. The procedure is the same as step 3. The recording will be stopped after entering the valid security code "**#xx**" and the incomplete message will be deleted. If "**0**" is entered, the Answering System will release the line, but the recorded message will still be retained.
6. If the user enters a wrong security code, the system will release the line.

Playing Messages Remotely

1. Press "**#1**", "**#2**" or "**#3**" on the touch tone keypad to play the messages in the corresponding mailbox.
2. The system will announce "Mailbox X. You have XX new messages and XX old messages" and the system will playback the new message only. If there are no new messages, the system will announce "Mailbox X. You have XX old messages. On the other hand, in the absence of old messages, the system will announce only the number of new messages.

Repeat Messages During Playback

1. Press "**#4**" once during message playback to repeat the current message.
2. Press "**#4**" twice within 2 seconds to skip to the previous message.

Skip Messages During Playback

REMOTE OPERATION OF ANSWERING SYSTEM

1. Press "#6" once to skip forward to the next message.

Stop Message Playback

1. Pressing "#5" during message playback will stop playback.

Deleting Messages

1. Press "#9" once during message playback to delete the current message.

Note: Playback will pause if "#" or " " is entered. Answering System will wait for the command in the following 2 seconds. If no further tone is entered, playback will be resumed.

Memo Recording

1. Press " 8".
2. After selecting the mailbox by entering command "1", "2", "3", You will hear, "Now recording", followed by a beep.
3. Enter "#5" to stop recording when you have finished.

Change OGM Remotely

1. Enter " 7" to record a new OGM. You will hear, "Now recording", followed by a beep to signal start of recording.
2. Press "#5" to stop recording. Your new OGM will playback automatically.

Check OGM1 Remotely

Enter "#7" to review OGM. You will hear playback of OGM followed by a beep.

Turning Answering System ON or OFF

Pressing "#0" toggles the Answering System **ON/OFF**. "Answer machine on", or "Answer machine off" will be announced, followed by a beep.

Voice Menu for Remote Operation

The system provides two pre-recorded voice menus to help you during remote operation. Press " 5", and you will hear the simple voice menu.

The simple voice menu is as follows:

- Press "#1" to play mailbox 1.
- Press "#2" to play mailbox 2.
- Press "#3" to play mailbox 3.
- Press "#5" to stop.
- Press "#4" to repeat the message.
- Press "#6" to skip the message.
- Press "#9" to erase the message.
- Press " 5" for other functions.
(To advance voice menu)

The advanced voice menu is as follows:

- Press "#7" to review outgoing message.
- Press " 7" to record outgoing message.

REMOTE OPERATION OF ANSWERING SYSTEM

- Press " 8" to record memo.
- Press "#4" twice to repeat previous message.
- Press "#0" to turn the system on or off.
- Press " 5" to return to the simple voice menu.

Pressing any function code will stop the voice menu, and perform the corresponding functions.

Exiting Remote Operation

1. Enter " 0" on the touch tone keypad to exit remote operation mode. The Answering System confirms your action with a long beep and then disconnects.
2. The Answering System also automatically disconnects if no key is pressed within 20 seconds during remote operation.

MAINTENANCE

Your VT 2961 cordless telephone contains sophisticated electronic parts, so it must be treated with care.

Avoid rough treatment

Please the Handset down gently. Save the original packing materials to protect your telephone if you ever need to ship it.

Avoid water

Your telephone can be damaged if it gets wet. Do not use the Handset outdoors in the rain, or handle it with wet hands. Do not install your Base Unit near a sink, bathtub or shower.

Electrical storms

Electrical storms can sometimes cause power surges harmful to electronic equipment. For your own safety, use caution when using electric appliances during storms.

Cleaning your telephone

Your telephone has a durable plastic casing that should retain its luster for many years. Clean it only with a soft cloth slightly dampened with water or a mild soap. Do not use excess water or cleaning solvents of any kind.

Remember that electrical appliances can cause serious injury if used when you are wet or standing in water. If your Base Unit should fall into water, **DO NOT RETRIEVE IT UNTIL YOU UNPLUG THE POWER CORD AND TELEPHONE LINE CORDS FROM THE WALL.** Then pull the unit out by the unplugged cords.

IN CASE OF DIFFICULTY

If you have difficulty operating your phone, the suggestions below should solve the problem. If you still have difficulty after trying these suggestions, call **VTECH** Communications at 1-800-595-9511. In Canada, call VTECH Electronics at 1-800-267-7377.

THE PHONE DOESN'T WORK AT ALL.

- Make sure the Power Cord is plugged in.
- Make sure the telephone line cords are plugged firmly into the base unit and the telephone wall jack.
- Make sure the batteries are properly charged. If the 'LOW BATTERY' message is shown, the battery pack needs charging.

NO DIAL TONE.

- First check all the suggestions above.
- If you still don't hear a dial tone, disconnect the base unit from the telephone jack and connect a different phone. If there is no dial tone on that phone either, the problem is in your wiring or local service. Call your local telephone company.

YOU GET NOISE, STATIC, OR A WEAK SIGNAL EVEN WHEN YOU'RE NEAR THE BASE UNIT.

- Household appliances plugged into the same circuit as the base unit can sometimes cause interference. Try moving the appliance or the base unit to another outlet.

YOU GET NOISE, STATIC, OR A WEAK SIGNAL WHEN YOU'RE AWAY FROM THE BASE UNIT.

- You may be out of range. Either move close to the base, or relocate the base unit.
- The layout of your home may be limiting the range. Try moving the base unit to another position.

THE HANDSET DOES NOT RING WHEN YOU RECEIVE A CALL.

- Make sure you have the handset ringer activated. To set the ringer, see "**SETTING THE HANDSET RINGER**".
- Make sure the telephone line cord is plugged firmly into the base unit and the telephone jack. Make sure the power cord is plugged in.
- You may be too far from the base unit.
- You may have too many extension phones on your telephone line to allow all of them to ring. Try unplugging some of the other phones.

IN CASE OF DIFFICULTY

YOU HEAR OTHER CALLS WHILE USING YOUR PHONE.

- Disconnect your base unit from the telephone jack, and plug in a regular telephone. If you still hear other calls, the problem is probably in your wiring or local service. Call your local telephone company.

YOU HEAR NOISE IN THE HANDSET, AND NONE OF THE KEYS OR BUTTONS WORK.

Make sure the power cord is plugged in.

COMMON CURE FOR ELECTRONIC EQUIPMENT

Electronics, like people, can sometimes get confused. If the unit does not seem to be responding normally, then try putting the handset in the cradle. If it does not seem to respond after trying this a few times, do the following (in the order listed):

1. Disconnect the power to the base.
2. Disconnect (remove) the handset battery pack.
3. Remove the base unit battery pack, where applicable.
4. Wait a few minutes.
5. Connect power to the base.
6. Install the handset battery pack.
7. Install the base unit battery pack, where applicable.
8. Place the handset in the base unit cradle. If the handset has not been recently charged, allow 8 hours before use.

WARRANTY STATEMENT

WHAT DOES OUR WARRANTY COVER?

- Any defect in material or workmanship.

FOR HOW LONG AFTER THE ORIGINAL PURCHASE?

- To the original purchaser only - ONE YEAR.

WHAT WILL VTECH DO?

- At our option, repair or replace your unit.

HOW DO I SEND MY UNIT, IN OR OUT OF WARRANTY?

- Call VTECH Communications customer service for Return Authorization at:
1-800-595-9511
in Canada, call VTECH Electronics at:
1-800-267-7377.
- Properly pack your unit. Include any cables & accessories which were originally provided with the product. We recommend using the original carton and packing materials.
- Include in the package a copy of the sales receipt or other evidence of date of original purchase (if the unit was purchased within the last twelve months).
- Print your name and address, along with a description of the defect, and include this in the package.
- Include payment for any service or repair not covered by warranty, as determined by VTECH Communications.
- Ship the unit via UPS Insured, or equivalent to:

VTECH COMMUNICATIONS

11035 SW 11th St.
Bldg . B Suite 270
BEAVERTON, OREGON 97005

In Canada, ship the unit via UPS Insured, or equivalent to:

VTECH ELECTRONICS

Suite 200- 7671 Alderbridge Way
Richmond, B.C. V6X 1Z9

VTECH Communications assumes no responsibility for units sent without prior Return Authorization.

WHAT DOES OUR WARRANTY NOT COVER?

- Batteries
- Damage from misuse, neglect, or acts of nature (lightning, floods, power surges, etc.)
- Products which may have been modified or incorporated into other products.
- Products purchased and/or operated outside the USA, its territories, or Canada.
- Products serviced by the owner or a service facility not expressly authorized by VTECH Communications.
- Products purchased more than 12 months from current date.
- Units purchased in "AS IS" condition, or units purchased as "Distressed Merchandise".

HOW DOES STATE LAW OR PROVINCE LAW RELATE TO THIS WARRANTY?

- This warranty gives you specific rights. You may also have other rights which vary from state to state or from province to province.

TECHNICAL SPECIFICATIONS

FREQUENCY CONTROL

Crystal Controlled Dual PLL Synthesizer

TRANSMIT FREQUENCY

Handset : 923.10 MHz to 927.75 MHz (All ten channels within this range)

Base : 902.3 MHz to 906.65 MHz (All ten channels within this range)

RECEIVE FREQUENCY

Handset : 902.3 MHz to 906.65 MHz (All ten channels within this range)

Base : 923.10 MHz to 927.75MHz (All ten channels within this range)

NOMINAL EFFECTIVE RANGE

Maximum power allowed by FCC and IC. Actual operating range may vary according to environmental conditions at the time of use.

SIZE

Handset : 17.5 x 6 x 4.5cm (L x W xT)
Maximum (Antenna excluded)

Base : 20.5 x 17x 70cm (L x W x T) Maximum (Antenna excluded)

WEIGHT

Handset : 205 grams

Base : 570 grams

POWER REQUIREMENTS

Handset : Self-contained nickel-cadmium rechargeable battery supply, 3.6V nominal, 600mAh capacity.

Base: 9VDC @ 500mA

MEMORY

Speed Dial: 50 Memory locations, 32 digits and 16 letters per location.

CID : Alpha Numeric Display 50 Memory locations

SPECIFICATIONS ARE TYPICAL AND MAY CHANGE WITHOUT NOTICE.

TABLE OF CONTENTS

PARTS CHECKLIST	1
FCC AND IC REGULATIONS	2
IMPORTANT SAFETY INSTRUCTIONS	2
SETTING UP YOUR VT2961	7
THE RBRC SEAL	6
WALL MOUNTING	7
HANDSET LAYOUT	8
BASE LAYOUT	9
BASIC TELEPHONE OPERATIONS	
Area Code Programming.....	10
key Beeps.....	12
Alternative Method.....	10
Making Calls.....	11
Speakerphone Trips.....	11
Redial/Pause.....	12
Answering Calls.....	12
Handset Volume	12
Speakerphone Volume.....	12
Call Timer.....	12
Hold.....	12
Call Waiting.....	13
Paging the Handset.....	13
Intercom.....	13
Setting The Handset Ringer.....	13
Base Unit Ringer.....	13
Handset Ringer Volume.....	13
Conference Calling.....	15
CALLER ID	
Reviewing the Call Log.....	15
Erasing Calls.....	15
Speed Dialing from Caller ID.....	15
DIRECTORY	
To Store a Name And Number.....	16
Storing a Caller ID Record in the Directory.....	17
Making Directory Calls.....	17
Editing a Directory Entry.....	17
Erasing a Directory Entry.....	17
BASE UNIT OPERATION	
Data Port.....	18

TABLE OF CONTENTS

ANSWERING SYSTEM SET UP.....	20
ANSWERING SYSTEM OPERATIONS.....	24
REMOTE OPERATION OF ANSWERING SYSTEM.....	29
MAINTENANCE.....	32
IN CASE OF DIFFICULTY.....	33
WARRANTY STATEMENT.....	35
TECHNICAL SPECIFICATIONS.....	36

vtech

VTECH TELECOMMUNICATIONS LTD.



A member of THE VTECH GROUP OF COMPANIES.

Distributed in the U.S.A. by VTech Communications Inc, Beaverton, Oregon, 97008

Distributed in the Canada by VTech Electronics Canada Ltd., Suite 200-7671 Alderbridge Way Richmond, B.C. V6X 1Z9.

Copyright 2000 for VTECH TELECOMMUNICATIONS LTD.
Printed in Mexico

91-xxxx-10-00
ISSUED 0