

## USER'S MANUAL



HANDSET



BASE UNIT

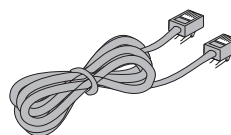

TELEPHONE LINE CORD

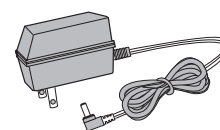

AC ADAPTER

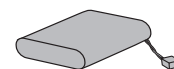

BATTERY PACK

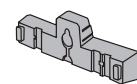

WALL MOUNTING BRACKET



BELT CLIP

To help protect the environment, this product may contain recycled or reconditioned parts and materials.

900 MHz

**vtech**

VTECH TELECOMMUNICATIONS LTD

Printed in China

91-5141-11-00 ISSUED 0

1

## INTRODUCTION

### Parts Check List:

1. Handset
2. Base Unit
3. Telephone line cord
4. AC adapter
5. Battery Pack
6. Wall mounting bracket
7. Belt Clip

## IMPORTANT SAFETY INSTRUCTIONS

When using your telephone equipment, basic safety precautions should always be followed to reduce the risk of fire, electric shock and injury to persons, including the following:

1. Read and understand all instructions.
2. Follow all warnings and instructions marked on the product.
3. Unplug this product from the wall outlet before cleaning. Do not use liquid cleaners or aerosol cleaners. Use a damp cloth for cleaning.
4. Do not use this product near water (for example, near a bath tub, kitchen sink, or swimming pool).
5. Do not place this product on an unstable cart, stand, or table. The product may fall, causing serious damage to the product.
6. Slots and openings in the cabinet and the back or bottom are provided for ventilation. To protect it from overheating, these openings must not be blocked by placing the product on the bed, sofa, rug, or other similar surface. This product should never be placed near or over a radiator or heat register. This product should not be placed in a built-in installation where proper ventilation is not provided.
7. This product should be operated only from the type of power source indicated on the marking label. If you are not sure of the type of power supply to your home, consult your dealer or local power company.
8. Do not allow anything to rest on the power cord. Do not locate this product where the cord will be abused by persons walking on it.
9. Never push objects of any kind into this product through cabinet slots as they may touch dangerous voltage points or short out parts that could result in a risk of fire or electric shock. Never spill liquid of any kind on the product.
10. To reduce the risk of electric shock, do not disassemble this product. If service or repair work is required, contact VTech Customer Service at 1-800-595-9511. Opening or removing cabinet parts other than specified access doors may expose you to dangerous voltages or other risks. Incorrect reassembling can cause electric shock when the appliance is subsequently used.
11. Do not overload wall outlets and extension cords as this can result in the risk of fire or electric shock.
12. Unplug this product from the wall outlet:
  - a) When the power supply cord or plug is damaged or frayed.
  - b) If liquid has been spilled into the product.
  - c) If the product has been exposed to rain or water.
  - d) If the product does not operate normally by following the operating instructions. Adjust only those controls that are covered by the operating instructions because improper adjustment of other controls may result in damage and will often require extensive work to restore the product to normal operation.
  - e) If the product has been dropped and the cabinet has been damaged.
  - f) If the product exhibits a distinct change in performance.
13. Avoid using a telephone (other than a cordless type) during an electrical storm. There may be a remote risk of electric shock from lightning.
14. Do not use the telephone to report a gas leak in the vicinity of the leak.

### SAVE THESE INSTRUCTIONS

## REPLACING THE HANDSET BATTERIES

1. Remove the battery case by pressing on the ridged lines and sliding downward.
2. Discard the old battery pack. Don't put the old battery pack in a trash compactor or a fire - it could burst.
3. Exercise care in handling batteries in order not to short the battery with conducting materials such as rings, bracelets, and keys. The battery or conductor may overheat and cause burns.
4. Do not dispose of the battery in a fire. The cell may explode.

**IMPORTANT:** Do not dispose of this battery in household garbage. For information on recycling or proper disposal, consult your local solid waste collection or disposal organization.

3. Hold the battery pack and plug the cord into the handset. (The two cord metal tips on the white plastic end of the plug should be facing upwards.) Place the cord in the case so it rests on top of the battery pack.
4. Replace the battery cover by sliding it into place.
5. The new battery pack must be charged before using your telephone. Place the handset in the cradle of the base unit to allow it to charge for 24 hours. Maximum battery life between charges is more than 5 hours of continuous talk time or 4 days of standby.

**CAUTION:** To reduce the Risk of Fire or Injury to Persons, Read and Follow these instructions:

1. Use only VTECH battery.

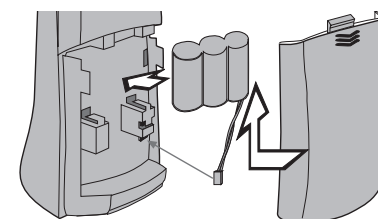
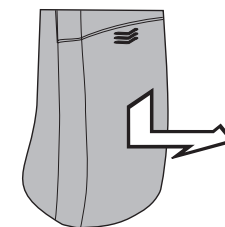

## GETTING STARTED

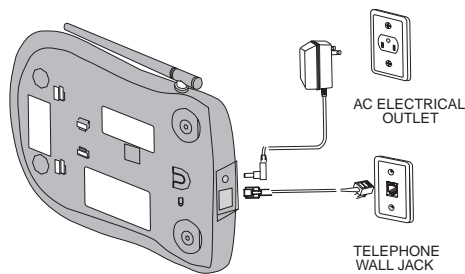

### Setting Up Your VT 9116

1. Choose an area near an electrical outlet and a telephone wall jack.
2. Plug the AC power adapter into an electrical outlet and the DC connector to the back of the base unit.

**CAUTION:** Use only the AC adapter shipped with your VT 9116. This is a Class 2 AC adapter, specifically designed for use with the VT 9116.

**NOTE:** Connect power to the base unit before placing the handset in the cradle.

3. **CHARGE THE HANDSET BATTERIES BEFORE USE.** The batteries recharge automatically whenever the handset is in the base unit cradle. The batteries must be charged for 24 hours before using your phone for the first time.
4. Connect the telephone line cord. Insert one end of the telephone line cord into the jack at the rear of the base unit. Plug

the other end into a telephone wall jack. Make sure the plugs snap securely into place.

5. **CHECK FOR A DIAL TONE.** After the batteries are charged, pick up the handset and press the PHONE key. The **PHONE** indicator should light up, and you should hear a dial tone. If not, see **IN CASE OF DIFFICULTY.**

#### CAUTION:

1. Never install telephone wiring during a lightning storm.
2. Never install telephone jacks in wet locations unless the jack is specifically designed for wet locations.
3. Never touch uninsulated telephone wires or terminals unless the telephone line has been disconnected at the network interface.
4. Use caution when installing or modifying telephone lines.

4

## WALL MOUNTING

1. **Choose a spot near an electrical outlet and a telephone jack.** Your phone requires a modular telephone jack and a standard electrical outlet (120V AC). The power cord is six feet long; make sure there is an electrical outlet within reach of the base. The outlet should not be controlled by a wall switch. If the switch is ever turned off, the phone will not operate.

2. **Position the wall mount adapter on the base.** Line up the tabs on the wall mount adapter with the holes on the bottom of the base. Snap the wall mount adapter firmly in place.

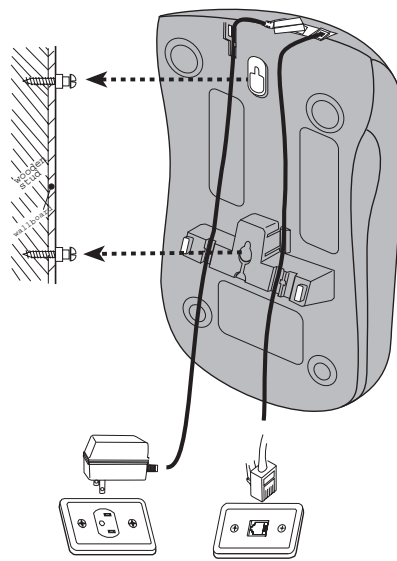

3. **Mount the base on the wall.** Position the base so the mounting studs will fit into the holes on the bottom of the base. Position the power cord to extend down the wall the phone is to be mounted on. Slide the base down on the mounting studs until it locks into place.

4. **Connect the telephone cord.** The telephone line cord has a snap-in plug at each end. Insert one of the plugs into the jack on the bottom of the base. Insert the other end of the plug into the wall jack.

5. **Connect the power cord.** Plug the DC connector into the DC jack at the rear of the base unit. Plug the AC power adapter into an electrical outlet.

6. Flip down the wall mount tab on the Base to secure the Handset when cradled.

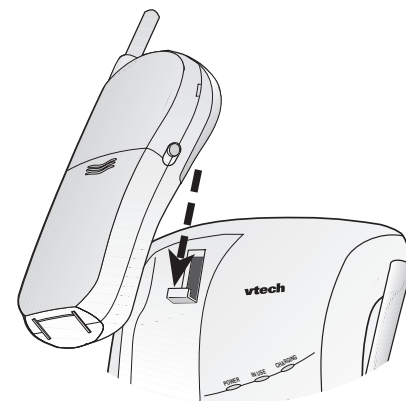

5

## BASE UNIT FEATURES



#### CHARGING LED

- \* The **CHARGING** LED illuminates steadily when the Handset is in the Base cradle to indicate that the Handset battery pack is being charged.

#### PAGE KEY

- \* Press the **PAGE** key to page the handset.
- \* Press it a second time to cancel a page.
- \* The base will ring the handset 1 min before ending the page automatically.
- \* The handset can also cancel the page by pressing the **OFF** key.

6

## HANDSET FEATURES

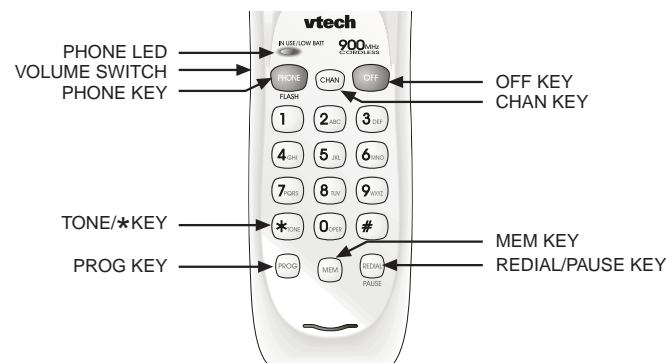

#### PHONE LED

- \* The **PHONE** LED lights when the phone line is being used by the handset.
- \* It flashes in cadence with an incoming ring.
- \* It flashes quickly during **PROG** mode.
- \* It flashes slowly when battery is low.

#### PHONE KEY/ FLASH KEY

- \* Press the **PHONE** key to make a call.
- \* If you are currently on a call, pressing **PHONE** flashes the line. This would be used with a feature like call waiting to answer your second call.

#### CHAN KEY

- \* Pressing the **CHAN** key when the handset is in use will activate a channel change to the next free channel.
- \* This is used if you are experiencing noise or interference on the current channel.

#### OFF KEY

- \* Press the **OFF** key to exit all modes of operation.

#### MEM KEY

- \* Press the **MEM** key to enter **MEMORY** mode.
- \* The sequence for dialing out a speed dial number in memory is: **PHONE**,

#### MEM, Number Button (0-9).

#### PROG KEY

- \* Press **PROG** key to enter **PROGRAM** mode. See Programming Speed Dial Numbers for more details.

#### REDIAL/PAUSE KEY

- \* When you hear the dial tone, pressing the **REDIAL** key will dial out the last number that was called on your phone.
- \* During Speed Dial programming, press **REDIAL** key to insert a 2 second **PAUSE** in the dialing sequence.
- \* It can also be used to store the last number dialed into the speed dial memory. See **Storing a Redial Number into Speed Dial** for details.

#### TONE/\* KEY

- \* In **PULSE** dialing mode, this key is used to switch to Temporary **TONE** dialing mode.

#### VOLUME SWITCH

- \* There are three volume settings: Low, Medium and High.

#### BATTERY LOW WARNING BEEP

- \* Upon pressing **PHONE**, the Handset will emit two beeps to indicate that the battery pack needs to be recharged.

7

### REPLACEMENT BATTERY ORDER FORM

For VTECH 9116 Cordless Telephone

Name: \_\_\_\_\_ Address: \_\_\_\_\_

City: \_\_\_\_\_ State: \_\_\_\_\_ Zip: \_\_\_\_\_

Daytime Phone Number: ( \_\_\_\_\_ ) \_\_\_\_\_ - \_\_\_\_\_

#### ORDER INFORMATION

For Model VT 9116

(QTY.) Batteries @\$14.95 each.....\$ \_\_\_\_\_

\$4.95 Shipping & Handling Per Battery Ordered.....\$ \_\_\_\_\_

#### METHOD OF PAYMENT: DO NOT SEND CASH

CHECK/M.O.  VISA  MASTERCARD  DISCOVER  AMERICAN EXPRESS

CREDIT CARD# \_\_\_\_\_ EXP. DATE \_\_\_\_\_

CARD HOLDER'S SIGNATURE \_\_\_\_\_

PLACE ORDER FORM AND PAYMENT IN ENVELOPE AND SEND TO:

VTECH COMMUNICATIONS  
8770 SW NIMBUS AVENUE  
BEAVERTON, OREGON 97008-7195  
YOU MAY ALSO ORDER BY PHONE. CALL 1-800-595-9511

## OPERATING INSTRUCTIONS

### Making Calls

Pick up the Handset and press **PHONE**. When you hear a dial tone, dial the number. The **PHONE LED** will illuminate while the Handset is in use.

If you make a mistake when dialing, press **OFF** to hang up, then press **PHONE** to get the dial tone again.

You must always press **PHONE** before you can dial a call on the handset.

### Answering Calls

When an incoming call is ringing, the **PHONE LED** on the handset will flash. To make sure your phone rings when the handset is away from the base, please keep the base antenna in the upright position.

To answer a call when the handset is in the base, just pick up the handset.

To answer a call when the handset is away from the base, just press any key on the handset (except **OFF**). This is very useful in a dark environment; you do not have to fumble around looking for the **PHONE** key to answer the call.

### Disconnecting

To end a call, either place the handset back in the base, or press **OFF** on the handset.

### Changing Channels

If you notice interference when using your handset, press **CHAN** to switch to a clear channel. This function is only available when you are on a call.



8

## OPERATING INSTRUCTIONS

### TONE/PULSE Setting

If you have touch tone service on phone line, Press **PROG**, \*, \*, **MEM** to switch to **TONE** dialing. If you have rotary service, press **PROG**, \*, #, **MEM** to switch to **PULSE** dialing.

**NOTE:** Your VT 9116 is preset at the factory for **TONE** dialing.

### Temporary Tone

If you have a rotary (dial-pulse) telephone service, (**TONE/PULSE** setting is set to **PULSE**), this feature allows you to enter special codes and tones to operate answering machines, use electronic banking services, calling cards, or other special services.

First, dial the call normally. Then activate the Temporary Tone feature by pressing **TONE** (the \* key). You can then press the numbers or symbols you need, and your phone will send the proper signals.

To end the call, press **OFF** or place the handset back in the base. The phone will automatically go back to rotary (dial-pulse) service.

### Programming The Ringer Type

The handset ringer is capable of four different types of ringing tones. The following sections detail how to change the different tones and to turn off a ringer on the handset. To program, the handset must be **OFF**.

To select a different ringer type do the following:

- \* Press **PROG**
- \* Press the # key.
- \* Press a key 1..4 to select a ringer type.
- \* Press the **MEM** key to confirm.

### Turning Off The Ringer

To turn off the ringer on the handset, do the following:

- \* Press **PROG**
- \* Press the # key
- \* Press 5 to turn off the ringer
- \* Press **MEM** to confirm
- \* To turn the ringer on again, see **Programming the Ringer Type**.

### Checking The Ringer

To check the ringer which is currently programmed, do the following:

- \* Press **PROG**
- \* Press the # key
- \* Press 0
- \* Press **MEM** to confirm

### Memory Dialing

The **VT 9116** can store up to 10 different phone numbers that you can dial just by pressing phone, **MEM** and one of the number keys (**0-9**).

### Programming Speed Dial Numbers

The handset must be **OFF**.

1. Press **PROG**. The **PHONE LED** will blink to indicate that you are in the programming mode.
2. Press the number of the memory location you wish to store the number in (**0-9**).
3. Using the dial pad, dial the number you want to store. The number can be up to 16 digits long. The number can be entered manually or by using **REDIAL**.
4. Press **MEM** to store the phone number to the key you selected.

The phone now exits **PROG** mode and you will hear a long confirmation beep.

### Speed Number Dialing

1. Press **PHONE** to get a dial tone.
2. Press **MEM** and the memory location number key (**0-9**).

For example, to dial the number you assigned to key '8', you would press **PHONE, MEM, 8**.

9

## OPERATING INSTRUCTIONS

### To Change or Replace a Speed Dial Number

To change or replace a stored number in speed dial memory simply enter the new number and store it in the memory location you wish to change.

For example, to change the number stored in memory position 7 to 555-1111, you would press **PROG, 7, 555-1111, MEM**.

### Storing Pauses in Memory

To insert a pause in a phone number, press **REDIAL/PAUSE** at the appropriate point when storing the number. This inserts a 2 second pause. For longer pauses, press **REDIAL/PAUSE** two or more times. Each press makes the pause 2 seconds longer and is treated as a stored digit.

If your phone is connected to a PBX you can store the PBX access number and a pause before the phone number. For example, to store **9-PAUSE-555-1234** in memory location 8 do the following:

1. Press **PROG**
2. Press **8**
3. Press **9**
4. Press **REDIAL/PAUSE**
5. Dial **555-1234**
6. Press **MEM**

### Using REDIAL

To **REDIAL** the last number you called, press **PHONE** then press **REDIAL**. The phone will automatically dial the number.

### Storing a Redial Number into Speed Dial

To store the last number you dialed as a regular Speed Dial number, press **PROG**, the desired location (**0-9**), **REDIAL**, **MEM**.

### The Page Feature

From the base unit, press **PAGE** to signal the person at the handset. To end the page at the base, press **PAGE** again. To end the page at the handset, press **OFF**.

This feature is also useful if you have misplaced the handset.

## The RBRC™ Seal



The RBRC® Seal on the nickel-cadmium battery contained in our product indicates that VTech Communications, INC. is voluntarily participating in an industry program to collect and recycle these batteries at the end of their useful lives, when taken out of service within the United States and Canada.

The RBRC® program provides a convenient alternative to placing used nickel-cadmium batteries into the trash or municipal waste, which may be illegal in your area.

VTech's partnership with RBRC® makes it easy for you to drop off the spent battery at local retailers participating in the RBRC®

program or authorized VTech product service centers. Please call **1-800-8-BATTERY™** for information on Ni-Cd battery recycling and disposal bans/restrictions in your area. VTech's involvement in this program is part of its commitment to protecting our environment and conserving natural resources.

**RBRC® is a registered trademark of Rechargeable Battery Recycling Corporation.**

10

## IN CASE OF DIFFICULTY

If you have difficulty operating your phone, the suggestions below should solve the problem. If you still have difficulty after trying these suggestions, In the **US** call:

**VTech Communications** at  
**1-800-595-9511**.

In **Canada** Call:

**VTech Electronics** at  
**1-800-267-7377**.

### THE PHONE DOESN'T WORK AT ALL.

- \* Make sure the power cord is plugged in.
- \* Make sure the telephone line cord is plugged firmly into the base unit and the telephone wall jack.
- \* Make sure the batteries are properly charged. If the handset makes two beeps, the battery needs charging. If the **PHONE** indicators do not light when you press **PHONE**, you must charge the batteries.
- \* If you recently installed a new battery pack, make sure it is installed correctly.

### NO DIAL TONE.

- \* First check all the suggestions above.
- \* If you still don't hear a dial tone, disconnect the base unit from the telephone jack and connect a different phone. If there is no dial tone on that phone either, the problem is in your wiring or local service. Call your local telephone company.

### YOU GET NOISE, STATIC, OR A WEAK SIGNAL EVEN WHEN YOU'RE NEAR THE BASE UNIT.

Household appliances plugged into the same circuit as the base unit can sometimes cause interference. Try moving the appliance or the base unit to another outlet.

### YOU GET NOISE, STATIC, OR A WEAK SIGNAL WHEN YOU'RE AWAY FROM THE BASE UNIT.

- \* You may be out of range. Either move closer to the base, or relocate the base unit.
- \* The layout of your home may be limiting the range. Try moving the base unit to the second or third floor, or to some other location.

### THE HANDSET DOES NOT RING WHEN YOU RECEIVE A CALL.

- \* Ensure that the ringer is turned on.
- \* Make sure the telephone line cord is plugged firmly into the base unit and the telephone wall jack. Make sure the power cord is plugged in.
- \* You may be too far from the base unit.
- \* You may have too many extension phones on your telephone line to allow all of them to ring. Try unplugging some of the other phones.

### YOUR CALLER FADES IN AND OUT.

You may be nearly out of range. Move closer, or relocate the base.

### YOU HEAR OTHER CALLS WHILE USING YOUR PHONE.

- \* Replace the handset in the base cradle, wait a few moments and try again.
- \* Disconnect your base unit from the telephone jack, and plug in a regular telephone. If you still hear other calls, the problem is probably in your wiring or local service. Call your local telephone company.

### YOU HEAR NOISE IN THE HANDSET, AND NONE OF THE KEYS OR BUTTONS WORK.

- \* Make sure the power cord is plugged in.
- \* Your base unit and handset may not be operating on the same channel. Place the handset in the cradle for a few moments to reset the channel.

### COMMON CURE FOR ELECTRONIC EQUIPMENT

Electronics, like people, can sometimes get confused. If the unit does not seem to be responding normally, then try putting the handset in the cradle to re-initialize the unit. If it still does not seem to respond, perform the following steps (in the order listed):

1. Disconnect the power to the base.
2. Disconnect the handset battery.
3. Wait a few minutes.
4. Connect power to the base.
5. Connect the handset battery.
6. Put the handset in the base to re-initialize.

11

## WARRANTY STATEMENT

### WHAT DOES OUR WARRANTY COVER?

- \* Any defect in material or workmanship.

### FOR HOW LONG AFTER THE ORIGINAL PURCHASE?

- \* One Year.

### WHAT WILL VTECH DO?

- \* At our option, repair or replace your unit.

### HOW DO I SEND MY UNIT, IN OR OUT OF WARRANTY?

- \* Call VTECH Communications customer service for Return Authorization at:

**1-800-595-9511**

- \* Properly pack your unit. Include any cables & accessories which were originally provided with the product. We recommend using the original carton and packing materials.
- \* Include in the package a copy of the sales receipt or other evidence of date of original purchase (if the unit was purchased within the last twelve months.)
- \* Print your name and address, along with a description of the defect, and include this in the package.
- \* Include payment for any service or repair not covered by the warranty, as determined by VTECH Communications.
- \* In the US, ship the unit via UPS Insured, or equivalent to:

**VTECH COMMUNICATIONS**

11035 SW 11th Street  
Bldg. B Suite 270  
Beaverton, OR 97005

*VTECH Communications assumes no responsibility for units sent without prior Return Authorization.*

### WHAT DOES OUR WARRANTY NOT COVER?

- \* Batteries
- \* Damage from misuse, neglect, or acts of nature (lightning, floods, power surges. etc.)
- \* Products which may have been modified or incorporated into other products
- \* Products purchased outside the USA
- \* Products serviced by the owner or a service facility not expressly authorized by VTECH Communications
- \* Products purchased more than 12 months from current date

### HOW DOES STATE LAW RELATE TO THIS WARRANTY?

- \* This warranty gives you specific rights. You may also have other rights which vary from state to state.

### IF YOU PURCHASED YOUR TELEPHONE IN CANADA

Please call: **1-800-267-7377**

Ship to: **VTECH ELECTRONICS**

200-7671 ALDERBRIDGE WAY

RICHMOND, BC V6X 1Z9

12

## MAINTENANCE

### TAKING CARE OF YOUR TELEPHONE

Your **VT 9116** cordless telephone contains sophisticated electronic parts so it must be treated with care.

### AVOID ROUGH TREATMENT

Place the handset down gently. Save the original packing materials to protect your telephone if you ever need to ship it.

### AVOID WATER

Your telephone can be damaged if it gets wet. Do not use the handset outdoors in the rain, or handle it with wet hands. Do not install your base unit near a sink, bathtub or shower. Remember that electrical appliances can cause serious injury if used when you are wet or standing in water. If your base unit should fall into water, **DO NOT RETRIEVE IT UNTIL YOU UNPLUG THE POWER CORD AND TELEPHONE LINE CORDS FROM THE WALL.** Then pull the unit out by the unplugged cords.

### ELECTRICAL STORMS

Electrical storms can sometimes cause power surges harmful to electronic equipment. For your own safety, use caution when using electric appliances during storms.

### CLEANING YOUR TELEPHONE

Your telephone has a durable plastic casing that should retain its luster for many years. Clean it only with a soft cloth slightly dampened with water or a mild soap. Do not use excess water or cleaning solvents of any kind.

## TECHNICAL SPECIFICATIONS

### FREQUENCY CONTROL

Crystal Controlled Dual PLL Synthesizer

### TRANSMIT FREQUENCY

Handset: 923.10MHz to 927.75 MHz

Base: 902.30 MHz to 906.65MHz

### RECEIVE FREQUENCY

Handset: 902.30 MHz to 906.65MHz

Base: 923.10MHz to 927.75 MHz

### NOMINAL EFFECTIVE RANGE

Maximum power allowed by FCC and IC. Actual operating range may vary according to environmental conditions at the time of use.

### SIZE

Handset: 20.8cm x 5.9cm x 4.3cm

(L x W x T) maximum

(antenna excluded)

Base: 19.3cm x 13.8cm x 6.2cm

(L x W x T) maximum

(antenna excluded)

### WEIGHT

Handset: 180grams

Base: 205grams

### POWER REQUIREMENTS

Handset: Self-contained nickel-cadmium rechargeable battery supply, 3.6V nominal, 400mAh capacity.

Power Adapter: 9V DC @ 200mA

**SPECIFICATIONS ARE TYPICAL AND MAY CHANGE WITHOUT NOTICE.**

## FCC AND IC REGULATIONS

### FCC AND IC REGULATIONS

This equipment complies with Parts 15 and 68 of the Federal Communications Commission (FCC) rules for the United States. It also complies with regulations RSS-210 and CS-03 of Industry Canada (IC).

A label is located on the underside of the base unit containing either the FCC registration number and Ringer Equivalence Number (REN) or the IC registration number and Load Number. You must, upon request, provide this information to your local telephone company.

This equipment is compatible with inductively coupled hearing aids.

### FCC Part 15

**Warning:** Changes or modifications to this unit not expressly approved by the party responsible for compliance could void the user's authority to operate the equipment.

The equipment has been tested and found to comply with part 15 of the FCC rules. These limits are designed to provide reasonable protection against harmful interference in a residential installation. This equipment generates, uses and can radiate radio frequency energy and, if not installed and used in accordance with the instructions, may cause harmful interference to radio communications. However, there is no guarantee that interference will not occur in a particular installation. If this equipment does cause harmful interference to radio or television reception, which can be determined by turning the equipment off and on, the user is encouraged to try and correct the interference by one or more of the following measures:

- \* Reorient or relocate the receiving antenna.
- \* Increase the separation between the equipment and receiver.
- \* Connect the equipment into an outlet or on a circuit different from that to which the receiver is connected.
- \* Consult the dealer or an experienced radio/TV technician for help.

### FCC Part 68

The FCC requires that you connect your cordless telephone to the nationwide telephone network through a modular telephone jack (USOC RJ11C or RJ11W).

Your telephone company may discontinue your service if your equipment causes harm to the telephone network. They will notify you in advance of disconnection, if possible. During notification, you will be informed of your right to file a complaint with the FCC.

If it is determined that your telephone equipment is malfunctioning, the FCC requires that it not be used and that it be unplugged from the modular jack until the problem has been corrected. Repairs to this telephone equipment can only be made by the manufacturer or its authorized agents or by others who may be authorized by the FCC. For repair procedures, follow the instructions outlined under the VTECH Limited Warranty.

The REN is useful in determining the number of devices you may connect to your telephone line and still enable the devices to ring when you receive a call. The general rule is that the REN value should not exceed 5.0 total; however, contact your local telephone company for the specific number in your area.

## FCC AND IC REGULATIONS

### IC (Industry Canada)

This telephone is registered for use in Canada.

**Notice:** The Industry Canada label identifies certified equipment. This certification means that the equipment meets certain telecommunications network, protective, operational and safety requirements. Industry Canada does not guarantee the equipment will operate to the user's satisfaction.

Before installing this equipment, users should ensure that it is permissible to be connected to the facilities of the local telecommunications company. The equipment must also be installed using an acceptable method of connections. The customer should be aware that compliance with the above conditions may not prevent degradation of service in situations.

Repairs to certified equipment should be made by an authorized Canadian maintenance facility designated by the supplier. Any repairs or alterations made by the user to this equipment, or equipment malfunctions, may give the telecommunications company cause to request the user to disconnect the equipment.

Users should ensure for their own protection that the electrical ground connections of the power utility, telephone lines and internal metallic water pipe system, if present, are connected together.

This precaution may be particularly important in rural areas.

**Caution:** Users should not attempt to make such connections themselves, but should contact appropriate electric inspection authority, or electrician, as appropriate.

**Notice:** The REN assigned to this device denotes the number of devices you may connect to the telephone loop, which is used by the device to prevent overloading. The termination on a loop may consist of any combination devices subjected only to the requirement that the sum of the REN does not exceed five.(5.0)

This device complies with RSS-210 of Industry Canada. Operation is subject to the following two conditions: (1) this device may not cause interference, and (2) this device must accept any interference, including interference that may cause undesired operation of the device.