

# INTRODUCTION

Congratulations! You have purchased one of the best performing cordless telephones on the market! The **VT 9241** is a two line 900 MHz cordless phone with Speakerphone & secondary keypad on the Base Unit.

## FEATURES:

- 2 Line Capability.
- 10 Number Speed Dial Memory (20 digits each).
- 30 Channels of operation.
- Automatic Search for clear channel.
- Manual channel change on the Handset.
- REDIAL feature.
- Programmable Ringer Types.
- Low Battery Detect and Warning indicator.
- Hearing-Aid Compatible Receiver.
- Easy answer - when the phone rings simply press any numeric key on the Handset to answer.
- Removable Battery Pack.
- Touch Tone and Pulse Dialing.
- Temporary Tone Mode.
- Spare Battery Charger in the Base Unit (second battery pack not included).
- Data Port in Base Unit.
- Handset and Speakerphone **HOLD**.
- Automatic release from hold when an extension telephone is activated.
- Handset and Speakerphone volume control.
- Flash.
- Ringer switch in Base (High-Low-Off) for each line.
- Four-way conversation between Line1, Line2, Handset and Speakerphone.
- Two-way Intercom between Handset and Base.
- 2.5mm Headset Jack on Handset.

- Belt Clip on the Handset.
- Long battery life (4.5 hours talk time/ 5 day standby).

This manual is designed to familiarize you with the **VT 9241**. To get the most use out of your **VT 9241**, we strongly recommend you read the manual before using your phone.

# INTRODUCTION

## Parts Check List:

1. Base Unit
2. Handset
3. AC adaptor
4. 2 telephone line cords
5. Battery pack
6. Belt clip
7. Wall mounting bracket

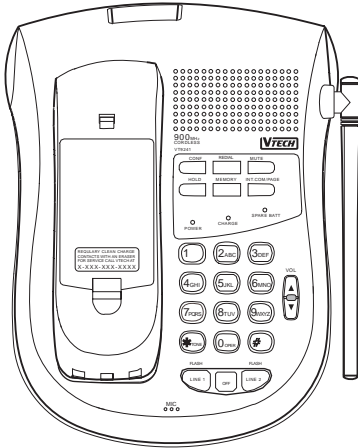

Base

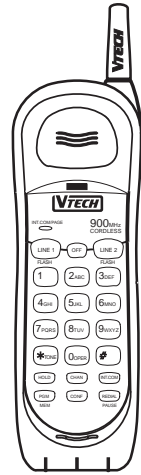

Handset

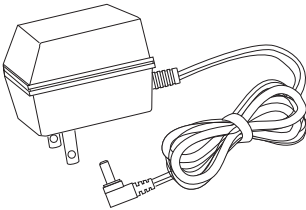

AC Adaptor

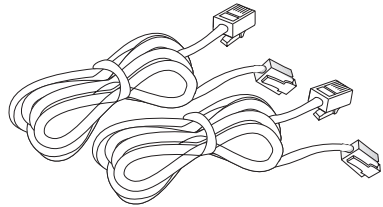

Telephone Line Cords

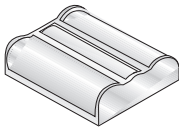

Battery Pack

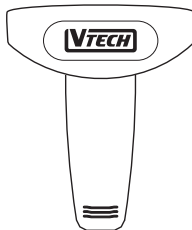

Belt Clip

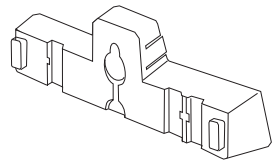

Wall Mounting Bracket

# IMPORTANT SAFETY INSTRUCTIONS

When using your telephone equipment, basic safety precautions should always be followed to reduce the risk of fire, electric shock and injury to persons, including the following:

1. Read and understand all instructions.
2. Follow all warnings and instructions marked on the product.
3. Unplug this product from the wall outlet before cleaning. Do not use liquid cleaners or aerosol cleaners. Use a damp cloth for cleaning.
4. Do not use this product near water (for example, near a bath tub, kitchen sink, or swimming pool).
5. Do not place this product on an unstable cart, stand, or table. The product may fall, causing serious damage to the product.
6. Slots and openings in the cabinet and the back or bottom are provided for ventilation. To protect it from overheating, these openings must not be blocked by placing the product on the bed, sofa, rug, or other similar surface. This product should never be placed near or over a radiator or heat register. This product should not be placed in a built-in installation where proper ventilation is not provided.
7. This product should be operated only from the type of power source indicated on the marking label. If you are not sure of the type of power supply to your home, consult your dealer or local power company.
8. Do not allow anything to rest on the power cord. Do not locate this product where the cord will be abused by persons walking on it.
9. Never push objects of any kind into this product through cabinet slots as they may touch dangerous voltage points or short out parts that could result in a risk of fire or electric shock. Never spill liquid of any kind on the product.
10. To reduce the risk of electric shock, do not disassemble this product. If service or repair work is required, contact VTech Customer Service at **1-800-595-9511**. Opening or removing cabinet parts other than specified access doors may expose you to dangerous voltages or other risks. Incorrect reassembling can cause electric shock when the appliance is subsequently used.
11. Do not overload wall outlets and extension cords as this can result in the risk of fire or electric shock.
12. Unplug this product from the wall outlet :
  - A. When the power supply cord or plug is damaged or frayed.
  - B. If liquid has been spilled into the product.
  - C. If the product has been exposed to rain or water.
  - D. If the product does not operate normally by following the operating instructions. Adjust only those controls that are covered by the oper-

# IMPORTANT SAFETY INSTRUCTIONS

ating instructions because improper adjustment of other controls may result in damage and will often require extensive work to restore the product to normal operation.

E.If the product has been dropped and the cabinet has been damaged.

F.If the product exhibits a distinct

change in performance.

13. Avoid using a telephone (other than a cordless type) during an electrical storm. There may be a remote risk of electric shock from lighting.

14. Do not use the telephone to report a gas leak in the vicinity of the leak.

## SAVE THESE INSTRUCTIONS

### The RBRC™ Seal

The RBRC® Seal on the nickel-cadmium battery indicates that VTech Communications, Inc. is voluntarily participating in an industry program to collect and recycle batteries at the end of their useful lives, when taken out of service within the United States and Canada.



The RBRC® program provides a convenient alternative to placing used nickel-cadmium batteries into the trash or municipal waste, which may be illegal in some areas.

VTech's partnership with RBRC® makes it easy for you to drop off the spent battery at local retailers

participating in the RBRC program or at authorized VTech product service centers. Please call

**1-800-8-BATTERY™** for information on Ni-Cd battery recycling and disposal bans/restrictions in your area. VTech's involvement in this program is part of its commitment to protecting our environment and conserving natural resources.

**RBRC® is a registered trademark of Rechargeable Battery Recycling Corporation.**

# REPLACING THE HANDSET BATTERY

1. Remove the battery case by pressing on the ridged lines and sliding downward.

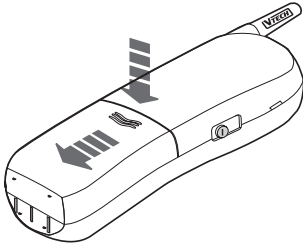

2. Discard the old Battery Pack. Don't put the old Battery Pack in a trash compactor or a fire - it could burst.

**IMPORTANT:** Do not dispose of this battery in household garbage. For information on recycling or proper disposal, consult your local solid waste collection or disposal organization.

3. Place the new Battery Pack in the battery compartment. Make sure the metal contacts on the underside of the battery are aligned with charging contacts in the battery compartment.

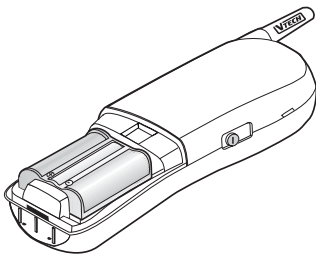

4. The new Battery Pack must be charged before using your telephone. Place the Handset in the

cradle of the Base Unit to allow it to charge for 16 hours.

**CAUTION:** To reduce the Risk of Fire or Injury to Persons, Read and Follow these Instructions:

1. Use only **VTECH** battery.
2. Do not open or mutilate the battery. Released electrolyte is corrosive and may cause damage to the eyes or skin. It may be toxic if swallowed.
3. Exercise care in handling batteries in order not to short the battery with conducting materials such as rings, bracelets, and keys. The battery or conductor may overheat and cause burns.
4. Do not dispose of the battery in a fire. The cell may explode.

# SPARE BATTERY CHARGER

Your VTech **VT 9241** is equipped with a spare battery charger built into the Base Unit. The spare battery charger allows you to always have a charged battery available, should your Handset battery discharge during normal use.

## To install the Spare Battery Pack:

1. Open the Base Unit battery compartment.

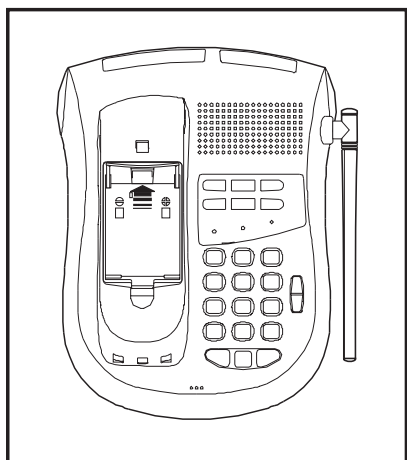

2. Place the spare Battery Pack in the battery compartment. Make sure the metal contacts on the underside of the battery are aligned with charging contacts in battery compartment.

3. Replace the battery compartment cover.

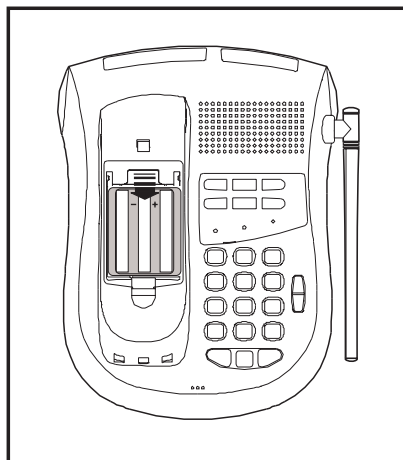

4. When the battery is installed properly, the spare battery LED on the Base Unit will be illuminated.
5. The spare battery will be fully charged after 24 hours. Please note that the **SPARE BATT** LED will always be illuminated when a spare battery is installed.

To order Battery Packs and Headsets, call VTech Communications at **1-800-595-9511**.

# GETTING STARTED

## Setting Up Your VT 9241

1. Choose an area near an electrical outlet and a telephone wall jack.
2. Plug the AC power adapter into an electrical outlet and the DC connector to the back of the Base Unit.

**NOTE:** Connect power to the Base Unit before placing the Handset in the cradle.

3. Set the **TONE/PULSE** switch located on the underside of the Base Unit. If you have touch tone service on your phone line, set the switch to **TONE**. If you have rotary service, set the switch to **PULSE**.

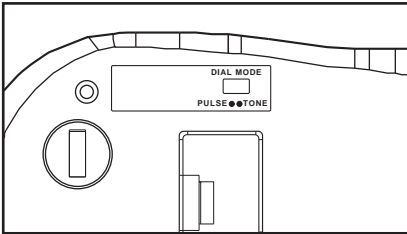

4. Set the **RINGER** switches to HIGH, LOW or OFF on the Base Unit.
5. **CHARGE THE HANDSET BATTERIES BEFORE USE.** The batteries

recharge automatically whenever the Handset is in the Base Unit cradle. The batteries must be charged for 16 hours before using your phone for the first time.

6. Connect the telephone line cord(s). If you have two lines which are serviced by one telephone jack (RJ14), insert one end of the four wire (black tipped) telephone line cord into the jack marked **L1/L2** at the rear of the Base Unit. Plug the other end into a telephone wall jack. If your two telephone lines are each serviced by a separate telephone jack (RJ11), insert one end of a telephone line cord into the jack marked **L1/L2** (this will be your line 1) and a second telephone cord into the jack marked **L2** (this will be your Line2) at the rear of the Base Unit. Plug the other end of the telephone cords into the appropriate wall jacks. Make sure the plugs snap securely into place.
7. **CHECK FOR A DIAL TONE.** After the batteries are charged, pick up the Handset and press a **LINE** key. The **LINE** key you pressed should light up, and you should hear a dial tone. If not, see IN CASE OF DIFFICULTY.

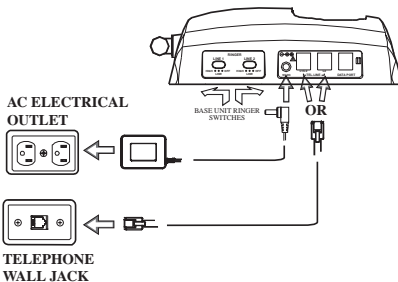

**CAUTION:** Use only the AC adapter shipped with your VT 9241. This is a Class 2 AC adapter, specifically designed for use with the VT 9241.

# GETTING STARTED

## CAUTION:

1. Never install telephone wiring during a lightning storm.
2. Never install telephone jacks in wet locations unless the jack is specifically designed for wet locations.
3. Never touch uninsulated telephone wires or terminals unless the telephone line has been disconnected at the network interface.
4. Use caution when installing or modifying telephone lines.

# WALL MOUNTING

The Wall Mount adaptor is designed to fit on standard Wall Mount plates.

1. **Choose a spot near an electrical outlet and a telephone jack.** Your phone requires a modular telephone jack and a standard electrical outlet (120V AC). The power cord is six feet long; make sure there is an electrical outlet within reach of the Base. The outlet should not be controlled by a wall switch. If the switch is ever turned off, the phone will not operate.
2. **Position the wall mount adaptor on the Base.** Line up the tabs on the wall mount adaptor with the holes on the bottom of the Base. Snap the wall mount adaptor firmly in place.
3. **Mount the Base on the wall.** Position the Base so the mounting studs will fit into the holes on the bottom of the Base. Position the power cord to extend down the wall the phone is to be mounted on. Slide the Base down on the mounting studs until it locks into place.
4. **Connect the telephone cord(s).** The telephone line cord has a snap-in plug at each end. Insert one of the plugs into the jack(s) on the bottom of the Base. Insert the other end of the plug into the wall jack(s).
5. **Connect the power cord.** Plug the DC connector into the DC jack at the rear of the Base Unit. Plug the AC power adaptor into an electrical outlet.

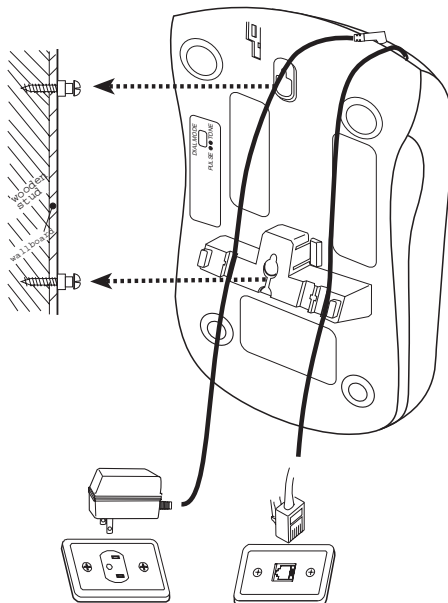

# HANDSET FEATURES

- INT.COM/LOW BATT LED

- \* It will flash when INT.COM key is pressed on the Base or Handset.
- \* It will illuminate during Intercom mode.
- \* It will flash slowly if handset battery level is low.

- LINE1 KEY

- \* Press this key to make or answer a call on LINE1.
- \* Press this key during a call on LINE1 to Flash the line.

- TONE/\* KEY

- \* In PULSE dialing mode, this key is used to switch to Temporary TONE dialing mode

- HOLD KEY

- \* When the Handset is in use, press this key to hold the line. To release HOLD, press the appropriate LINE key.

- PGM/MEM KEY

- \* In Handset idle mode, press this key to enter PROGRAM mode.
- \* Press this key to enter memory dial mode, after getting a dial tone.

- VOLUME SWITCH

Set earpiece volume to high, medium or low, depending on your preference.

- OFF KEY

- \* Press this key to exit all modes.

- HEADSET JACK

- \* Connect a 2.5mm headset to the jack for hands free operation.

- LINE2 KEY

- \* Press this key to make or answer a call on LINE2.
- \* Press this key during a call on LINE2 to Flash the line.

- INT.COM KEY

- \* Press this key to ring the Base Unit and establish an Intercom call.

- CHAN KEY

- \* Pressing the CHAN key when the Handset is in use will activate a channel change to the next free channel. This is used if you are experiencing noise or interference on the current channel.

- REDIAL/PAUSE KEY

- \* Press this key to dial the last number called on your Handset.
- \* During Speed Dial programming, press this key to insert a 2 second PAUSE in the dialing sequence.

- CONF KEY

- \* Press this key to establish a Conference call between LINE1 and LINE2.

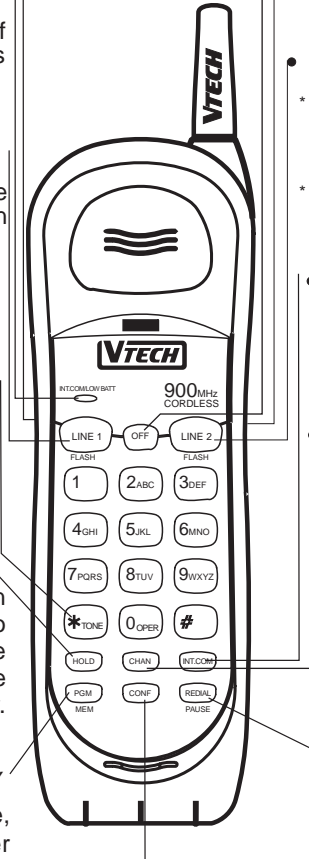

# BASE UNIT FEATURES

- **CONF KEY**

\* Press this key to establish a Conference call between LINE1 and LINE2.

- **REDIAL KEY**

\* Press this key to dial the last number called from the Base.

- **MUTE KEY/LED**

\* Press this key during an active call to disable the microphone. Press MUTE again to return to a 2-way conversation.

\* While the SPEAKERPHONE is on, this LED will illuminate after pressing the MUTE key.

- **INT.COM/PAGE KEY/LED**

\* Press this key to page the Handset. The LED will flash while the Handset is paged, and it will glow steadily during Intercom mode.

- **MEMORY KEY**

\* Press this key to enter Memory mode.

- **SPARE BATT LED**

\* The SPARE BATT LED lights up after a battery pack is placed in the spare battery compartment.

- **POWER LED**

\* It illuminates when the base power adaptor is plugged in and power is applied to the base unit.

- **HOLD KEY**

\* Press this key to place a Speakerphone call on hold.

\* Press the appropriate LINE key to return to the call.

- **CHARGE LED**

\* The CHARGE LED illuminates steadily to indicate that the Handset battery is being charged.

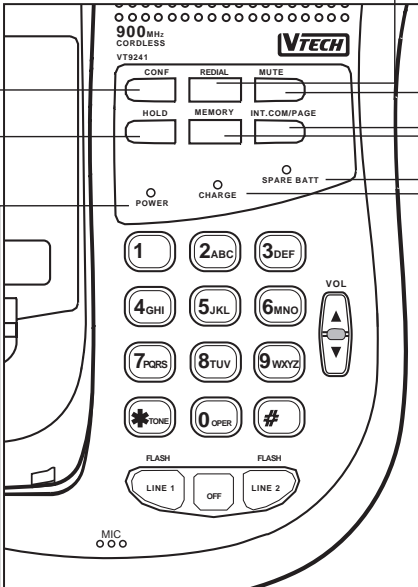

# BASE UNIT FEATURES

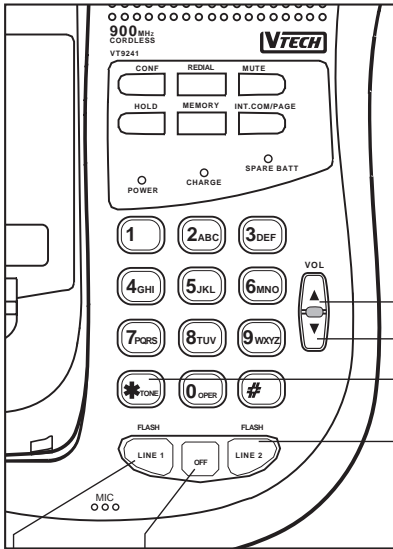

## ● VOLUME UP KEY

\* Press this key to adjust the speaker volume. There are total of 8 volume level settings.

## ● VOLUME DOWN KEY

\* Press this key to adjust the speaker volume. There are total of 8 volume level settings.

## ● TONE/\* KEY

\* In PULSE dialing mode, this key is used to switch to Temporary Tone.

## ● LINE2 KEY

\* Press this key to get dial tone or answer an incoming call on LINE2.

\* Press this key to Flash LINE2 while using the Speakerphone.

## ● OFF KEY

\* Press this key to hang up a line or end an Intercom call.

## ● LINE1 KEY

\* Press this key to get dial tone or answer incoming call on LINE1 using the Speakerphone.

\* Press this key to Flash operation in LINE1 while using the Speakerphone.

## ● RINGER SWITCHES

\* These switches will set the Base Ringer to HIGH, LOW or OFF.

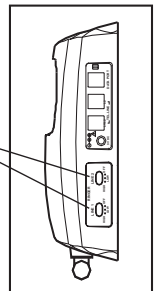

## ● TONE/PULSE SWITCH

\* Located on the underside of the Base Unit, this switch sets your primary dialing mode. Most phone lines use Tone dialing.

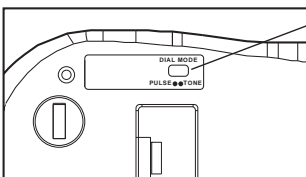

# OPERATING INSTRUCTIONS

## MAKING CALLS

### From the Handset

1. Pick up the Handset and press **LINE1** or **LINE2**.

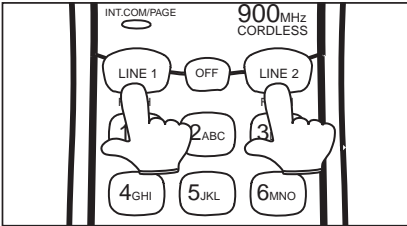

2. When you hear a dial tone, dial the number. The **LINE** key you pressed on Handset will light up and the corresponding **LINE** on Base Unit will double Flash.

If you make a mistake when dialing, press **OFF** to hang up, then press **LINE1** or **LINE2** to get dial tone again.

You must always press **LINE1** or **LINE2** before you can dial a call on the Handset.

### Disconnecting

To end a call,

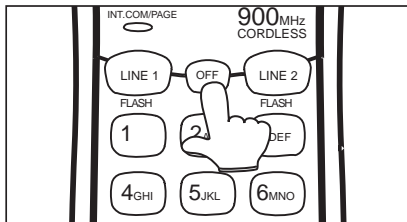

1. Press **OFF** on the Handset;

**OR,**

2. Place the Handset back in the Base Unit cradle.

### From the Base

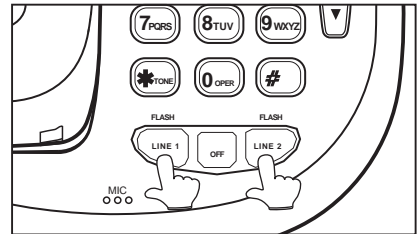

The Base Unit allows you to make and receive calls without using the Handset. You can use the Speakerphone on Base while the Handset is in or out of the Base.

1. Press the **LINE1** or **LINE2** on the Base Unit.
2. You will hear the dial tone over the speaker.
3. Adjust the volume controls on the face of the Base Unit if necessary.
4. Dial the number on the dial pad of the Base Unit.
5. When the party answers, speak toward the microphone.

# OPERATING INSTRUCTIONS

## Disconnecting

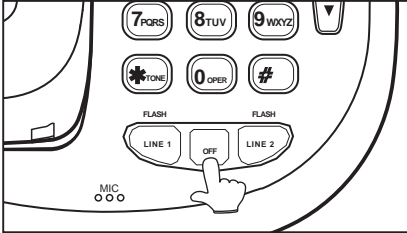

To end the call and hang up, press **OFF** on the Base Unit.

## ANSWER A CALL

### By the Handset

If your phone rings, the **LINE 1** (or **LINE 2**) on the Handset will illuminate, and the corresponding **LINE** key on the Base will be flashing.

1. When the Handset is in the Base. You can answer the call by just picking up the Handset.
2. If the Handset rings when it is away from the Base, press the appropriate **LINE** key, or any numeric key to answer the call.

### By the Base Unit

The Base will ring and the appropriate **LINE** key will Flash. You can answer by pressing the corresponding **LINE** key.

## TO PUT A CALL ON HOLD

While using the Speakerphone or the Handset, you can put a call on hold by pressing **HOLD**. The **LINE** key on the Base or Handset will blink and the Base or Handset will emit an alert beep every 20 seconds to indicate a

call is on hold.

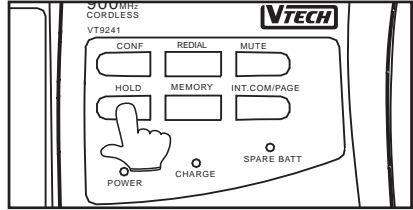

To return to the call, press the corresponding **LINE** key on the Base Unit or Handset.

If a call is on HOLD using the **VT 9241** and the user picks up another phone on the same line, the **VT 9241** will automatically take itself off HOLD and turn OFF.

## THE MUTE FEATURE

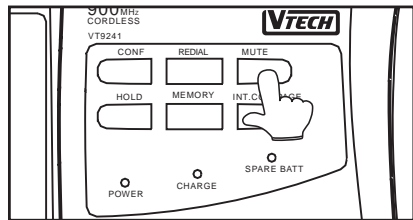

1. When you press the **MUTE** key while using the Speakerphone, you can hear your party's voice, but your party can't hear you.
2. While the call is muted, the **MUTE** indicator will be lit.
3. To go back to the two-way conversation, press **MUTE** again.

## TIPS ON USING THE VT 9241 SPEAKERPHONE:

1. Adjust the Speakerphone volume to a comfortable listening level by

# OPERATING INSTRUCTIONS

pressing the **VOL UP ▲** or **DOWN ▼** keys.

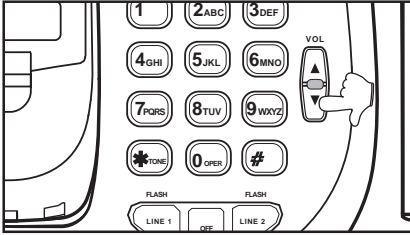

2. If there is background noise in the area where you are using the Speakerphone, (people talking, a radio or television playing, for example), you may experience some degree of “chopping” or “dropout” as your party speaks. To remedy this, do the following:

- \* Try to lower the source of the background noise in your environment; otherwise;
- \* When it's your party's turn to talk, press the **MUTE** key. The **MUTE LED** will glow. When it is your turn to speak, press **MUTE** again to reactivate the Base Unit microphone.

## MAKING OR ANSWERING A CALL WHILE YOU'RE ALREADY ON A CALL

**NOTE:** For 2-Line operation, you will need 2-Line phone service from your local service provider; each line with its own, unique phone number. The **VT 9241** will work as a single line phone as well.

## From the Handset

If you are on a call, and you wish to either make or answer a call on the unused line, you can:

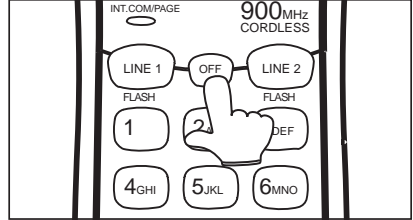

Press **OFF** to end your original call, then press the other **LINE** key;

## OR

Press the other **LINE** key first. Your original call will automatically be placed on **HOLD**. You now have the following options:

1. Press **OFF** to end the call you're currently on, then press the other **LINE** key to return to the original call.

## OR

2. **CONFERENCE** Lines 1 and 2 together. For more details, see **CONFERENCE CALLING**.

## From the Base Unit

If you are on a call, and want to answer a call ringing on the unused line, you can:

Press **OFF** to end the original call, then press the appropriate **LINE** key to answer the new call;

## OR

# OPERATING INSTRUCTIONS

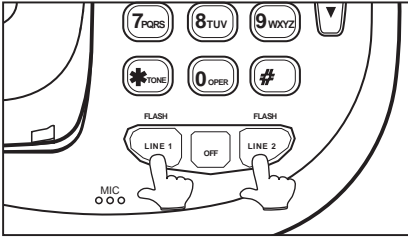

Press the appropriate **LINE** key to answer the new call. The original call will automatically be placed on **HOLD**. You can then:

1. Press **OFF** when you're done with the current call, then press the flashing **LINE** key to return to your original call.
2. **CONFERENCE** Lines 1 and 2 together. For more details, see **CONFERENCE CALLING**.

## SWITCHING YOUR CALL FROM THE BASE UNIT (SPEAKERPHONE) TO THE HANDSET

1. Press **HOLD** on the Base Unit
2. Press the appropriate **LINE** key on the Handset

## SWITCHING YOUR CALL FROM HANDSET TO THE BASE UNIT (SPEAKERPHONE)

1. Press **HOLD** on the Handset

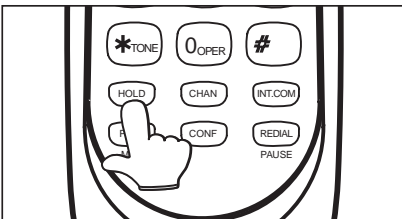

2. Press the appropriate **LINE** key on the Base Unit

**NOTE:** You cannot switch back to the Speakerphone just by returning the Handset to the Base. That will disconnect the call.

## JOINING A CONVERSATION

### From the Base

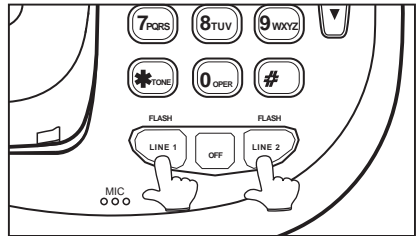

1. If someone is speaking on the Handset, you can join the conversation just by pressing **LINE 1** or **LINE 2** on the Base Unit.
2. Either party can then leave the conversation by pressing **OFF**.

### From the Handset

1. If you are using the Speakerphone, someone at the Handset can join the conversation by pressing **LINE 1** (or **LINE 2**) on the Handset, depending on which line is active.

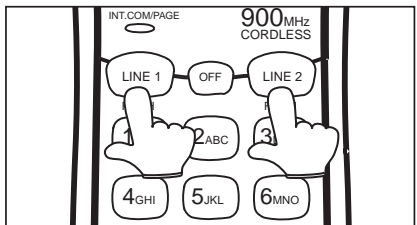

# OPERATING INSTRUCTIONS

2. Either party can leave the conversation by pressing **OFF** key.

To disconnect the call, both the Handset and the Base Unit must hang up . Otherwise the call will still remain connected.

## USING THE INTERCOM

You can use your **VT 9241** 2 line cordless telephone as a two-way Intercom between the Base Unit and the Handset. This doesn't tie up your telephone line. You can still receive calls when using the Intercom.

The Intercom function can be activated by either the Handset or the Base Unit.

### From the Handset

1. Press **INT.COM** key.

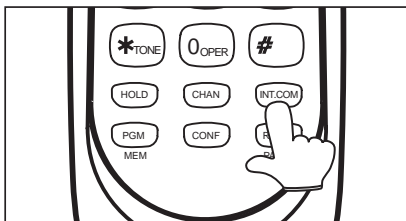

2. The **INT.COM/LOW BATT** LED will illuminate and a tone will sound.
3. The Base will ring and the **INT.COM/PAGE** LED will light. It will then automatically enter Intercom mode.
4. Speak towards the microphone on the front edge of the Base Unit.

### From the Base

1. Press **INT.COM/PAGE** on Base.

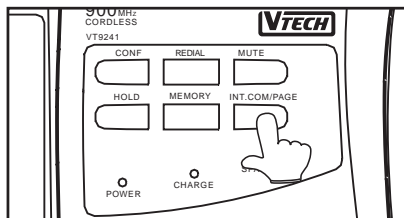

2. The **INT.COM/PAGE** LED on Base and the **INT.COM/LOW BATT** LED on Handset will blink and a tone will sound at Handset.

To exit Intercom mode at the Base Unit or Handset, press **OFF**.

3. To answer the page at the Handset, press **INT.COM** and speak with the person at the Base Unit.

### NOTE:

1.The Handset will ring a maximum of 60 seconds.

2.If the Handset is in use, it will ring only once.

To end the Intercom call at the Base or Handset, press **OFF**.

If you receive an Intercom/Page from the Base Unit while you are on a phone call on the Handset,

1. Press **INT.COM** key on Handset,
2. Intercom mode is active after a signal is heard.

# OPERATING INSTRUCTIONS

To return to the phone call, press the appropriate **LINE** key on Base or Handset.

## IF YOUR PHONE RINGS DURING AN INTERCOM CONVERSATION

If you receive a call while using the Intercom, the Base will only ring once, and the Handset will generate 3 alerting tones through the earpiece. The **LINE** key will flash on both Base and Handset. You can answer the incoming call by pressing the **LINE** key of the ringing line on the Base or Handset. However, by answering the incoming call you will automatically exit the Intercom mode.

## USING THE INTERCOM DURING A PHONE CALL

The **HOLD** feature allows you to put a phone call on hold and use the Intercom without disconnecting your caller. It works at the Handset or the Base.

1. While you are on the call on the Handset, press the **INT.COM** key to automatically place the active call on hold, and to establish an Intercom call between the Handset and Base.

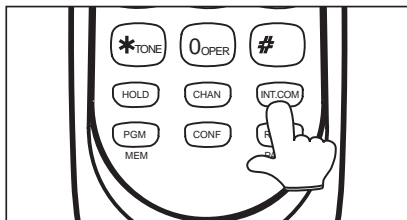

2. While you are on the call on the Base Unit, press **HOLD** and then

press **INT.COM/PAGE** on the Base to page the Handset. Then press **INT.COM** on the Handset to enter Intercom mode.

3. To end the Intercom conversation, press **OFF** on either the Handset or **OFF** on the Base Unit.
4. To return to the call, press the appropriate **LINE** key on the Handset or Base.

## TEMPORARY TONE FEATURE

If you have rotary (dial-pulse) telephone service, (**TONE/PULSE** switch is set to **PULSE**), this feature allows you to enter special codes and tones to operate answering machines, use electronic banking services, calling cards, or other special services.

To do this:

1. Dial the call normally.
2. Activate the temporary tone feature by pressing **TONE** (the **\*** key).
3. Press the numbers or symbols you need, and your phone will send the proper signals.

This feature is available on both the Handset and the Base Unit.

To end the call, press **OFF**. The phone will automatically go back to rotary (dial-pulse) service.

## PROGRAMMING THE RINGER TYPE

The **VT 9241** features four different Handset ringer types for each line.

# OPERATING INSTRUCTIONS

To program, The Handset must be **OFF**.

To select a different ringer type do the following:

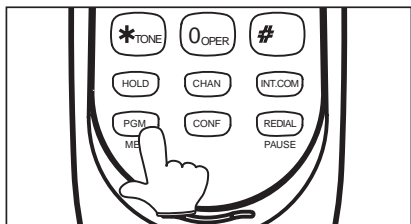

1. Press **PGM/MEM** key
2. Press the **#** key
3. Press 1 for **LINE1** or 2 for **LINE2**
4. Press a key **1..4** to select a ringer type

The **VT 9241** will ring once to show the type of ringer selected.

5. Press the **OFF** key to exit.

## TURNING OFF THE RINGERS

To turn off the ringer on the Handset do the following:

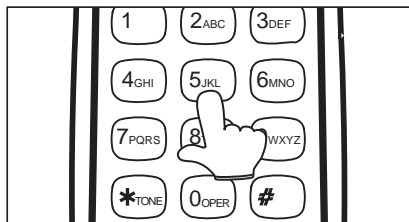

1. Press **PGM/MEM**
2. Press the **#** key

3. Press 1 for **LINE1** or 2 for **LINE2**
4. Press **5** to turn off the ringer
5. Press the **OFF** key to exit

To turn off the ringer on the Base Unit set the **RINGER** switch to **OFF**.

## CHECKING THE RINGER

To check the Handset ringer which is currently programmed do the following:

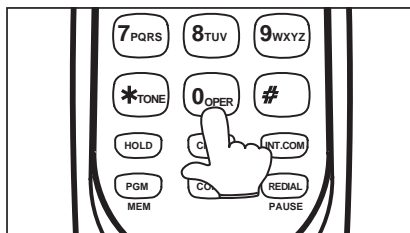

1. Press **PGM/MEM**
2. Press the **#** key
3. Press 1 for **LINE1** or 2 for **LINE2**
4. Press **0**

The phone will ring once to show ringer selected.

5. Press the **OFF** key to exit

## MEMORY DIALING

The **VT 9241** Cordless Phone can store up to 10 different phone numbers that you can dial just by pressing **PGM/MEM** and the memory location.

# OPERATING INSTRUCTIONS

## TO STORE A NUMBER INTO MEMORY

The Handset must be **OFF**.

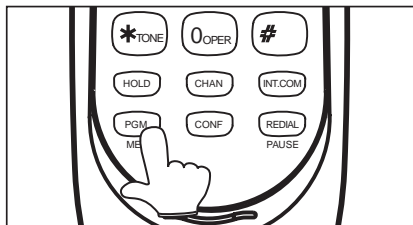

1. Press **PGM/MEM** on Handset
2. Press the number of the memory location you wish to store the phone number in (0-9). The Handset will beep once.
3. Using the dialpad, dial the number you want to store. The number can be up to 20 digits long.
4. Press **PGM/MEM** to store the number into its assigned memory location.
  - If programming has been successful, a happy tone will be generated.
  - If programming was unsuccessful, a sad tone is generated.
  - If more than 20 digits are keyed in or the phone is left unattended in program mode for more than 30 seconds, it will generate a sad tone and automatically exit program mode.
  - Follow the steps above for each number you want to store, assigning each phone number to a differ-

ent memory key.

## TO SPEED DIAL A STORED NUMBER

You can speed dial from the Handset or Base Unit.

1. Press **LINE1** or **LINE2** to get a dial tone.

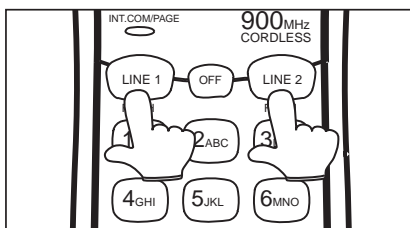

2. Press **PGM/MEM** on the Handset or **MEMORY** on the Base.
3. Press the number key (**0-9**) to enter the memory location.

For example, to dial the number you assigned to key '8', you would press **LINE (1 or 2), MEMORY, 8** on the Base; or **LINE (1 or 2), PGM/MEM, 8** on the Handset.

## TO CHANGE OR REPLACE A STORED NUMBER

You can change or replace a stored number just by storing a new number in its place.

## STORING A PAUSE IN A SPEED DIAL NUMBER

To insert a pause in a phone number, press **REDIAL/PAUSE** at the appropriate point when storing the number. This inserts a 2 second pause. For longer

# OPERATING INSTRUCTIONS

pauses, press **REDIAL/PAUSE** two or more times. Each press makes the pause 2 seconds longer and is treated as a stored digit.

If your phone is connected to a **PBX** you can store the **PBX** access number and a pause before the phone number. For example, to store 9-PAUSE-555-1234, in memory location 8, do the following:

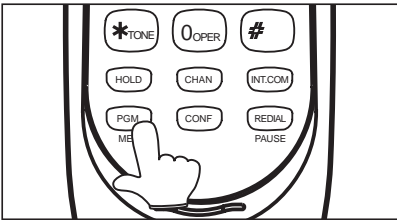

1. Press **PGM/MEM** on Handset
2. Press **8**
3. Press **9**
4. Press **REDIAL/PAUSE**
5. Dial **555-1234**
6. Press **MEM**

## USING REDIAL

The **VT 9241** cordless phone automatically stores the last number you dialed in a special redial memory.

To dial the number again,

1. Press **LINE1** or **LINE2**.
2. Press **REDIAL/PAUSE**.

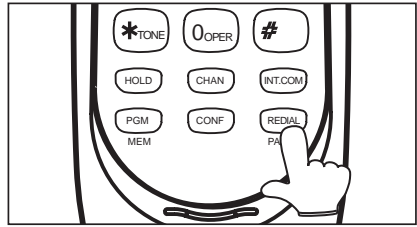

- This feature is also available on the Base Unit. It will store the last number dialed from the Speakerphone.

## STORING A REDIAL NUMBER IN MEMORY (SPEED) DIAL

To store the last number you dialed as a regular Speed Dial number,

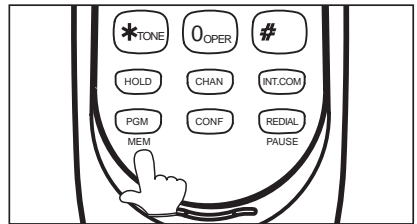

1. Press **PGM/MEM**;
2. Press a location (0-9);
3. Press **REDIAL/PAUSE**;
4. Press **MEM**.

## CONFERENCE CALLING

### From the Handset or Base

Once you are on a call (either **LINE1** or **LINE2**).

1. Press the available **LINE** key to either make or answer your second call.

# OPERATING INSTRUCTIONS

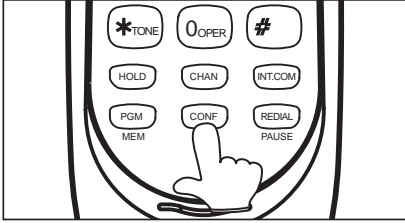

2. Your original call will automatically be placed on **HOLD**.
3. Press **CONF** to join both lines together. Both **LINE** keys will glow during a Conference call.

## Switching A Conference Call From Handset To Base Unit

Once you have established a Conference call on Handset,

1. Press **HOLD** on the Handset.
2. Press **CONF** on the Base Unit.

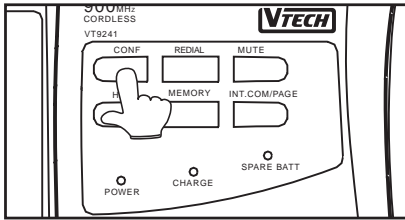

3. Your Conference call has now been transferred to the Speakerphone.

## Switching A Conference Call From Base Unit To Handset

Once you have established a Conference Call on the Base,

1. Press **HOLD** on the Base

2. Press **CONF** key on the Handset.
3. Your conference call has now been transferred to the Handset.

## 4-Way Conference Calling

Both the Handset and Base Unit can participate in a Conference call at the same time. Once the Conference call has been established on the Handset (or Base):

1. Press **LINE1** on the Base Unit (or Handset)
2. Press **LINE2** on the Base Unit (or Handset)
3. Press **CONF** on the Base Unit (or Handset)

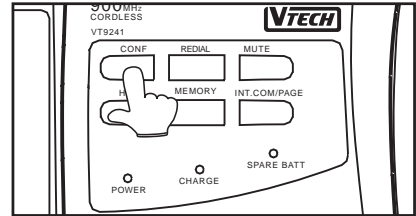

4. The Base Unit or Handset can exit the Conference call by pressing **OFF**.

## Ending One Side Or Entire Conference Call

If you want to end the call with only one person,

1. Press the **LINE** key of the person you want to disconnect
2. Press **OFF**

# OPERATING INSTRUCTIONS

3. Press the **LINE** key to return to the remaining call.

If you want to end the entire Conference call, press **OFF** on the Handset (or Base) while both Lines are active.

**CAUTION:** If the Handset and Speakerphone are on the same call, a loud squeal due to feedback may occur unless there is reasonable separation between the two components.

## CHANGING CHANNELS

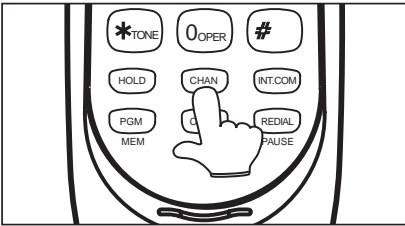

If you notice interference when using your Handset, press **CHAN** to switch to a clear channel. This function is only available when you are on a call or using Intercom.

# OPERATING INSTRUCTIONS

## OPTIONAL HEADSET INSTALLATION AND OPERATING INSTRUCTIONS

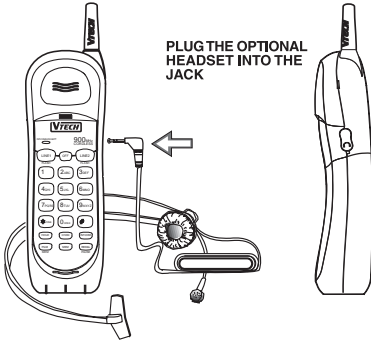

**NOTE:** Whenever a compatible Headset is connected to the cordless Handset, the microphone on the Handset will be MUTED. This is done to limit the effect of background noise.

The following operational characteristics apply to VTech Headsets. The same may also apply to other (non-VTech) compatible Headsets, but VTech assumes no responsibility for their performance.

Your **VT 9241** cordless telephone is equipped with a 2.5mm Headset Jack for use with an optional accessory Headset for hands-free operation.

- The VTech brand compatible Headset has a reversible, monaural design. You can wear it on either ear, leaving one ear free for room conversation.

If you choose to use the Headset option, you must do the following:

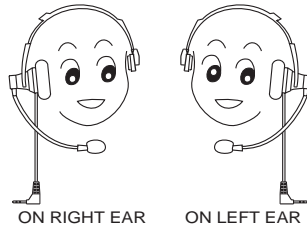

### INSTALLATION

Obtain an optional accessory Headset, which is compatible with the **VT 9241**.

- The headband can be adjusted to fit the contour of your head. Using both hands, slide the headband up or down so that it rests comfortably on your head with the speaker cushion centered against your ear.

Please contact VTech Communications Customer Service, toll-free at **1-800-595-9511** for dealer information in your local area. You can also purchase a compatible Headset directly from VTech Communications Customer Service.

Once you have a compatible 2.5mm Headset, locate the Headset Jack on the Handset of your **VT 9241**. Connect the plug of the Headset to the jack on the cordless Handset. The plug should fit securely. Do not force the connection.

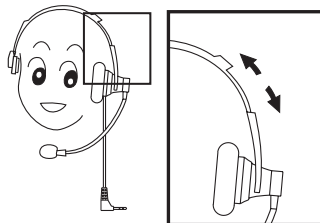

# OPERATING INSTRUCTIONS

- For maximum sound quality, the flexible microphone should be positioned at the corner of your mouth, about one inch from your mouth.

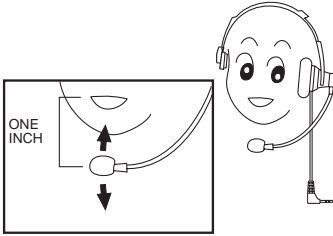

- The **VT 9241** is also equipped with a detachable Belt clip. Align the pins on the inside edge of the Belt clip with the notches on the side of the **VT 9241** Handset. The Belt clip should snap securely into place. Do not force the connection. See Illustration.

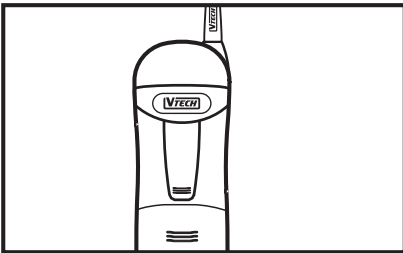

# DATA PORT

Your **VT 9241** has a convenient feature: a Data Port built into the Base Unit. This port provides an easy way to connect your fax machine, modem, or other telephone device for direct access to Line2.

The Data Port is a standard RJ-11 jack, and is located on the back of the Base Unit.

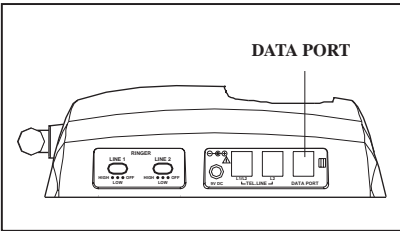

The Data Port only provides access to Line2, so you must have an active line connected to the **LINE2** input on the back of the **VT 9241** Base. To use the Data Port for access to dial tone on Line2, simply connect a standard phone cord, with RJ-11 connectors, from the Data Port to your fax machine, modem, or other telephone device.

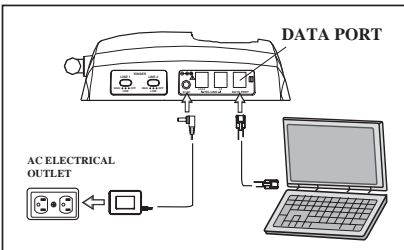

## NOTE:

While the Data Port is being used, accidental access of Line2 by the **VT 9241** or extension phone sharing the same line may interrupt a fax, modem or data transmission.

# MAINTENANCE

## TAKING CARE OF YOUR TELEPHONE.

excess water or cleaning solvents of any kind.

Your VTech **VT 9241** cordless telephone contains sophisticated electronic parts so it must be treated with care.

- Avoid rough treatment  
Place the Handset down gently. Save the original packing materials to protect your telephone if you ever need to ship it.
- Avoid water  
Your telephone can be damaged if it gets wet. Do not use the Handset outdoors in the rain, or handle it with wet hands. Do not install your Base Unit near a sink, bathtub or shower.

Remember that electrical appliances can cause serious injury if used when you are wet or standing in water. If your Base Unit should fall into water, **DO NOT RETRIEVE IT UNTIL YOU UNPLUG THE POWER CORD AND TELEPHONE LINE CORDS FROM THE WALL.** Then pull the unit out by the unplugged cords.

### • ELECTRICAL STORMS

Electrical storms can sometimes cause power surges harmful to electronic equipment.

- For your own safety, use caution when using electric appliances during storms.
- Cleaning your telephone  
Your telephone has a durable plastic casing that should retain its luster for many years. Clean it only with a soft cloth slightly dampened with water or a mild soap. Do not use

# IN CASE OF DIFFICULTY

If you have difficulty operating your phone, the suggestions below should solve the problem. If you still have difficulty after trying these suggestions, In the US call:

**VTECH Communications at  
1-800-595-9511**

In Canada call:  
**VTECH Electronics at  
1-800-267-7377.**

## THE PHONE DOESN'T WORK AT ALL.

- Make sure the power cord is plugged in.
- Make sure the telephone line cord is plugged firmly into the Base Unit and the telephone wall jack.
- Make sure the batteries are properly charged. If the Low Battery indicator is on, the battery needs charging. If the **IN USE** and **PHONE** indicators do not light when you press **PHONE**, you must charge the batteries.
- If you recently installed a new Battery Pack, make sure it is installed correctly.

## NO DIAL TONE.

- First check all the suggestions above.
- If you still don't hear a dial tone, disconnect the Base Unit from the telephone jack and connect a different phone. If there is no dial tone on

that phone either, the problem is in your wiring or local service. Call your local telephone company.

## YOU GET NOISE, STATIC, OR A WEAK SIGNAL EVEN WHEN YOU'RE NEAR THE BASE UNIT.

- Place the Handset in the Base momentarily to re-set the security code. Then press **PHONE** to get a line.
- Check the Low Battery indicator. If it is on, place the Handset in the Base cradle for recharging the battery.

Household appliances plugged into the same circuit as the Base Unit can sometimes cause interference. Try moving the appliance or the Base Unit to another outlet.

## YOU GET NOISE, STATIC, OR A WEAK SIGNAL WHEN YOU'RE AWAY FROM THE BASE UNIT.

- You may be out of range. Either move closer to the Base, or relocate the Base Unit.
- The layout of your home may be limiting the range. Try moving the Base Unit to the second or third floor, or to some other location.

## THE HANDSET DOES NOT RING WHEN YOU RECEIVE A CALL.

- Ensure that the ringer is turned on.
- Make sure the telephone line cord is plugged firmly into the Base Unit and the telephone jack. Make sure the power cord is plugged in.

# IN CASE OF DIFFICULTY

- You may be too far from the Base Unit.
- You may have too many extension phones on your telephone line to allow all of them to ring. Try unplugging some of the other phones.
- Your Base Unit and Handset may not be operating on the same channel or security code. Place the Handset in the cradle for a few moments to reload the security code and reset the channel.

## THE BASE DOES NOT RING

- Make sure the **BASE RINGER** switch is not set to off.
- There may be too many extension phones on your line. Try unplugging one of the other phones.

## YOUR CALLER FADES IN AND OUT.

- You may be nearly out of range. Move closer, or relocate the Base.

## YOU HEAR OTHER CALLS WHILE USING YOUR PHONE.

- Replace the Handset in the Base cradle, wait a few moments and try again.
- Change the channel by pressing **CHAN** key on Handset.
- Disconnect your Base Unit from the telephone jack, and plug in a regular corded telephone. If you still hear other calls, the problem is probably in your wiring or local service. Call your local telephone company.

## YOU HEAR NOISE IN THE HANDSET, AND NONE OF THE KEYS OR BUTTONS WORK.

- Make sure the power cord is plugged in.

## COMMON CURE FOR ELECTRONIC EQUIPMENT

Electronics, like people, can sometimes get confused. If the unit does not seem to be responding normally, then try putting the Handset in the cradle to re-initialize the unit. If it still does not seem to respond, perform the following steps (in the order listed):

1. Disconnect the power to the Base.
2. Disconnect the Handset battery.
3. Remove the spare battery from the Base Unit spare battery charger, if in use.
4. Wait a few minutes.
5. Connect power to the Base.
6. Connect the Handset battery.
7. Put the Handset in the Base to re-initialize.

# WARRANTY STATEMENT

## WHAT DOES OUR WARRANTY COVER?

- Any defect in material or workmanship.

## FOR HOW LONG AFTER THE ORIGINAL PURCHASE?

- One Year.

## WHAT WILL VTECH DO?

- At our option, repair or replace your unit.

## HOW DO I SEND MY UNIT, IN OR OUT OF WARRANTY?

- Call VTECH Communications customer service for Return Authorization at: **1-800-595-9511**, In Canada call VTech Electronics at **1-800-267-7377**.
- Properly pack your unit. Include any cables & accessories which were originally provided with the product. We recommend using the original carton and packing materials.
- Include in the package a copy of the sales receipt or other evidence of date of original purchase (if the unit was purchased within the last twelve months).
- Print your name and address, along with a description of the defect, and include this in the package.
- Include payment for any service or repair not covered by warranty, as determined by VTECH Communications.
- In the **US**, ship the unit via **UPS** Insured, or equivalent to:

**VTECH COMMUNICATIONS**  
**11035 SW 11th Street**  
**Bldg. B Suite 270**  
**Beaverton, OR 97005**

In Canada ship the unit via UPS Insured, or equivalent to:

**VTECH ELECTRONICS**  
**Suite 200-7671 Alderbridge Way**  
**Richmond, B.C. V6X 1Z9**

*VTECH Communications assumes no responsibility for units sent without prior Return Authorization.*

# WARRANTY STATEMENT

*VTECH Communications assumes no WARRANTY STATEMENT responsibility for units sent without prior Return Authorization.*

## WHAT DOES OUR WARRANTY NOT COVER?

- Batteries;
- Damage from misuse, neglect, or acts of nature (lightning, floods, power surges, etc.);
- Products which may have been modified or incorporated into other products;
- Products purchased outside the USA;
- Products serviced by the owner or a service facility not expressly authorized by **VTECH** Communications;
- Products purchased more than 12 months from current date.

## HOW DOES STATE LAW RELATE TO THIS WARRANTY?

- This warranty gives you specific rights. You may also have other rights which vary from state to state.

# FCC AND IC REGULATIONS

This equipment complies with Parts 15 and 68 of the Federal Communications Commission (**FCC**) rules for the United States. It also complies with regulations RSS210 and CS-03 of Industry and Science Canada. Operation is subject to the following two conditions: (1) this device may not cause interference, and (2) this device must accept any interference, including interference that may cause undesired operation of the device.

The underside of the Base Unit containing engravements of either the **FCC** registration number and Ringer Equivalence Number (**REN**), or the **IC** registration number. You must, upon request, provide this information to your local telephone company.

This equipment is compatible with inductively coupled hearing aids.

Should you experience trouble with this telephone equipment, please contact:

**In the United States:**

**VTECH COMMUNICATIONS**

**1-800-595-9511.**

**In Canada:**

**VTECH ELECTRONICS**

**1-800-267-7377.**

The telephone company may ask you to disconnect this equipment from the line network until the problem has been corrected.

## **FCC Part 15**

Warning: Changes or modifications to this unit not expressly approved by the party responsible for compliance could void the user's authority to operate the equipment.

The equipment has been tested and found to comply with part 15 of the FCC rules. These limits are designed to provide reasonable protection against harmful interference in a residential installation. This equipment generates, uses and can radiate radio frequency energy and, if not installed and used in accordance with the instructions, may cause harmful interference to radio communications. However, there is no guarantee that interference will not occur in a particular installation. If this equipment does cause harmful interference to radio or television reception, which can be determined by turning the equipment off and on, the user is encouraged to try and correct the interference by one or more of the following measures:

- Reorient or relocate the receiving antenna.
- Increase the separation between the equipment and receiver.
- Connect the equipment into an outlet or on a circuit different from that to which the receiver is connected.
- Consult the dealer or an experienced radio/TV technician for help.

## **FCC Part 68**

The **FCC** requires that you connect your cordless telephone to the nationwide telephone network through a modular telephone jack (USOC RJ11C, RJ11W or RJ14).

Your telephone company may discontinue your service if your equipment causes harm to the telephone network.

# FCC AND IC REGULATIONS

They will notify you in advance of disconnection, if possible. During notification, you will be informed of your right to file a complaint with the **FCC**.

Occasionally, your telephone company may make changes in its facilities, equipment, operation, or procedures that could affect the operation of your equipment. If so, you will be given advance notice of the change to give you an opportunity to maintain uninterrupted service.

The Base Unit contains no user serviceable parts. The Handset contains a user replaceable Battery Pack.

If it is determined that your telephone equipment is malfunctioning, the **FCC** requires that it not be used and that it be unplugged from the modular jack until the problem has been corrected. Repairs to this telephone equipment can only be made by the manufacturer or its authorized agents or by others who may be authorized by the **FCC**. For repair procedures, follow the instructions outlined under the Limited Warranty.

This equipment may not be used on coin service provided by the phone company or Party Lines.

The **REN** is useful in determining the number of devices you may connect to your telephone line and still enable the devices to ring when you receive a call. The general rule is that the REN value should not exceed 5.0 total; however, contact your local telephone company for the specific number in your area.

## IC (Industry Canada)

This telephone is registered for use in Canada.

**Notice:** The Ringer Equivalence Number (REN) assigned to each terminal device denotes the percentage of the total load to be connected to a telephone loop which is used by the device, to prevent overloading. The termination of a loop may consist of any combination of devices subject only to the requirement that the sum of the Ringer Equivalent Numbers of all devices not exceed 5.0.

**Notice:** The Industry Canada label identifies certified equipment. This certification means that the equipment meets certain telecommunications network protective, operational and safety requirements. The Department does not guarantee the equipment will operate to the user's satisfaction.

Before installing this equipment, users should ensure that it is permissible to be connected to the facilities of the local telecommunications company. The equipment must also be installed using an acceptable method of connection. The customer should be aware that compliance with the above conditions may not prevent degradation of services in some situations.

Repairs to certified equipment should be made by an authorized Canadian maintenance facility designated by the supplier. Any repairs or alterations made by the user to this equipment, or equipment malfunctions, may give the

# FCC AND IC REGULATIONS

telecommunications company cause to request the user to disconnect the equipment.

Users should ensure, for their own protection, that the electrical ground connections of the power utility, telephone lines and internal metallic water pipe system, if present, are connected together. This precaution may be particularly important in rural areas.

**CAUTION:** Users should not attempt to make such connections themselves, but should contact the appropriate electrical inspection authority, or electrician, as appropriate.

Your VTech **VT 9241** is designed to operate at the maximum power allowed by the FCC and IC. This means your Handset and Base Unit can communicate only over a certain distance - which will depend on the location of the Base Unit and Handset, weather, and the construction and layout of your home or office.

# TECHNICAL SPECIFICATIONS

## FREQUENCY CONTROL

- Crystal Controlled Dual PLL Synthesizer

## TRANSMIT FREQUENCY

- Handset: 923.10 MHz to 927.75 MHz (All thirty channels within this range)
- Base: 902.3 MHz to 906.65 MHz (All thirty channels within this range)

## RECEIVE FREQUENCY

- Handset: 902.3 MHz to 906.65 MHz (All thirty channels within this range)
- Base: 923.10 MHz to 927.75 MHz (All thirty channels within this range)

## NOMINAL EFFECTIVE RANGE

- Maximum power allowed by **FCC**. Actual operating range may vary according to environmental conditions at the time of use.
- The range quoted for this phone is Based on open field measurements under ideal conditions.

## SIZE

- Handset: 17.3cm x 5.6cm x 3.8cm (L x W x T) maximum (antenna excluded)
- Base: 21.9cm x 16.4cm x 5.4cm (L x W x T) maximum (antenna excluded)

## WEIGHT

- Handset: 180 grams
- Base: 500 grams

## POWER REQUIREMENTS

- Handset: Self-contained nickel-cadmium rechargeable battery supply, 3.6V nominal, 400mAh capacity.
- Power Adapter: 9V DC@500mA

**SPECIFICATIONS ARE TYPICAL AND MAY CHANGE WITHOUT NOTICE.**

# TABLE OF CONTENTS

INTRODUCTION.....	1
Parts Check List.....	2
IMPORTANT SAFETY INSTRUCTIONS.....	3
REPLACING THE HANDSET BATTERY.....	5
SPARE BATTERY CHARGER.....	6
GETTING STARTED.....	7
Setting Up Your VT 9241.....	7
WALL MOUNTING.....	9
HANDSET FEATURES.....	10
INT.COM/LOW BATT LED.....	10
LINE1 KEY.....	10
TONE/* KEY.....	10
HOLD KEY.....	10
PGM/MEM KEY.....	10
CONF KEY.....	10
VOLUME SWITCH.....	10
OFF KEY.....	10
HEADSET JACK.....	10
LINE2 KEY.....	10
INT.COM KEY.....	10
CHAN KEY.....	10
REDIAL/PAUSE KEY.....	10
BASE UNIT FEATURES.....	11
CONF KEY.....	11
POWER LED.....	11
HOLD KEY.....	11
REDIAL KEY.....	11
MUTE KEY/LED.....	11
INT.COM/PAGE KEY/LED.....	11
MEMORY KEY.....	11
SPARE BATT LED.....	11
CHARGE LED.....	11
VOLUME UP KEY.....	12
VOLUME DOWN KEY.....	12
TONE/* KEY.....	12
LINE2 KEY.....	12
OFF KEY.....	12
LINE1 KEY.....	12
RINGER SWITCHES.....	12
TONE/PULSE SWITCH.....	12
OPERATING INSTRUCTIONS.....	13
MAKING CALLS.....	13
ANSWER A CALL.....	14
TO PUT A CALL ON HOLD.....	14
THE MUTE FEATURE.....	14

# TABLE OF CONTENTS

TIPS ON USING THE VT9241 SPEAKERPHONE.....	14
MAKING OR ANSWERING A CALL WHILE YOU'RE ALREADY ON A CALL .....	15
SWITCHING YOUR CALL FROM THE BASE UNIT (SPEAKERPHONE) TO THE HANDSET .....	16
SWITCHING YOUR CALL FROM THE HANDSET TO THE BASE UNIT (SPEAKERPHONE) .....	16
JOINING A CONVERSATION.....	16
USING THE INTERCOM.....	17
IF YOUR PHONE RINGS DURING AN INTERCOM CONVERSATION.....	18
USING THE INTERCOM DURING A PHONE CALL.....	18
TEMPORARY TONE FEATURE.....	18
PROGRAMMING THE RINGER TYPE.....	18
TURNING OFF THE RINGERS.....	19
CHECKING THE RINGER.....	19
MEMORY DIALING.....	19
TO STORE A NUMBER INTO MEMORY.....	20
TO SPEED DIAL A STORED NUMBER.....	20
TO CHANGE OR REPLACE A STORED NUMBER.....	20
STORING A PAUSE IN A SPEED DIAL NUMBER.....	20
USING REDIAL.....	21
STORING A REDIAL NUMBER IN MEMORY (SPEED) DIAL.....	21
CONFERENCE CALLING.....	21
CHANGING CHANNELS.....	23
OPTIONAL HEADSET INSTALLATION AND OPERATING INSTRUCTIONS .....	24
DATA PORT.....	26
MAINTENANCE.....	27
IN CASE OF DIFFICULTY.....	28
WARRANTY STATEMENT.....	30
FCC AND IC REGULATIONS.....	32
TECHNICAL SPECIFICATIONS.....	35



VTECH COMMUNICATIONS LTD.

Distributed in the U.S.A. by VTECH Communications, Beaverton, OR

Distributed in Canada by VTECH Electronics Canada Ltd., 200-7671 Alderbridge Way,  
Richmond, B.C., V6X 1Z9

Copyright 1999 for VTECH COMMUNICATIONS LTD.

MADE IN CHINA

**91-5073-10-00**  
**ISSUE 0**