

# Important Safety Instructions

---

When using your telephone equipment, basic safety precautions should always be followed to reduce the risk of fire, electric shock and injury to persons, including the following:

1. Read and understand all instructions.
2. Follow all warnings and instructions marked on the product.
3. Unplug this product from the wall outlet before cleaning. Do not use liquid cleaners or aerosol cleaners. Use a damp cloth for cleaning.
4. Do not use this product near water (for example, near a bath tub, kitchen sink, or swimming pool).
5. Do not place this product on an unstable cart, stand, or table. The product may fall, causing serious damage to the product.
6. Slots and openings in the cabinet and the back or bottom are provided for ventilation. To protect it from overheating, these openings must not be blocked by placing the product on the bed, sofa, rug, or other similar surface. This product should never be placed near or over a radiator or heat register. This product should not be placed in a built-in installation where proper ventilation is not provided.
7. This product should be operated only from the type of power source indicated on the marking label. If you are not sure of the type of power supply to your home, consult your dealer or local power company.
8. Do not allow anything to rest on the power cord. Do not locate this product where the cord will be abused by persons walking on it.
9. Never push objects of any kind into this product through cabinet slots as they may touch dangerous voltage points or short out parts that could result in a risk of fire or electric shock. Never spill liquid of any kind on the product.
10. To reduce the risk of electric shock, do not disassemble this product, but take it to a VTech authorized service facility. Opening or removing cabinet parts other than specified access doors may expose you to dangerous voltages or other risks. Incorrect reassembling can cause electric shock when the appliance is subsequently used.
11. Do not overload wall outlets and extension cords as this can result in the risk of fire or electric shock.

- 
12. Unplug this product from the wall outlet and refer servicing to a VTECH authorized service facility under the following conditions:
    - A. When the power supply cord or plug is damaged or frayed.
    - B. If liquid has been spilled into the product.
    - C. If the product has been exposed to rain or water.
    - D. If the product does not operate normally by following the operating instructions. Adjust only those controls that are covered by the operating instructions, because improper adjustment of other controls may result in damage and will often require extensive work by a VTech authorized technician to restore the product to normal operation.
    - E. If the product has been dropped and the cabinet has been damaged.
    - F. If the product exhibits a distinct change in performance.
  13. Avoid using a telephone (other than a cordless type) during an electrical storm. There may be a remote risk of electric shock from lightning.
  14. Do not use the telephone to report a gas leak in the vicinity of the leak.

## **VTECH COMMUNICATIONS INC**

SERVICE DEPT. at 1-800-595-9511. In Canada, call VTech Electronics Ltd at 1-800-267-7377.

# **SAVE THESE INSTRUCTIONS**

# Introduction

---

The **GIGAPHONE** is an advanced cordless telephone that operates in the 2.4GHz frequency range. Your **GIGAPHONE** is capable of supporting up to a maximum of 4 Handsets. Using additional Handsets, up to three people can be conferenced on a call (2 Handsets and the Base Speakerphone), or two extensions can be conferenced on a call, while two other extensions can be talking internally, using the Intercom feature.

This manual is designed to familiarize you with the **GIGAPHONE** cordless telephone. We strongly recommend you read the manual before using your phone.

**To order additional system Handsets (model# VT 2420), battery packs, or headsets, call VTech Communications Inc at 1-800-595-9511.**

## IMPORTANT

Please record the Base ID#(BS ID) printed on the underside of the GIGAPHONE Base in the space below. Please be certain to include all 15 digits/characters.

Base ID # \_\_\_\_\_

# Parts Check List

1. Base Unit
2. Handset
3. AC Power Adapter
4. Telephone Cord
5. Battery Pack
6. Wall Mounting Bracket
7. Belt clip
8. Owner's Manual
9. Quick Reference Guide

To purchase replacement battery packs, call VTech Communications Inc at 1-800-595-9511. In Canada, call VTech Electronics Ltd at 1-800-267-7377.



Handset

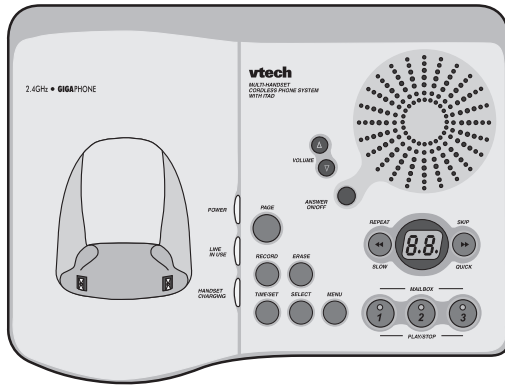

Base Unit

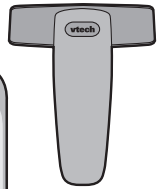

Belt Clip

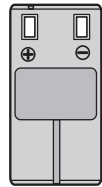

Battery Pack

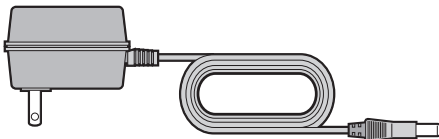

AC Power Adapter

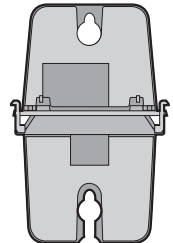

Wall Mounting Bracket

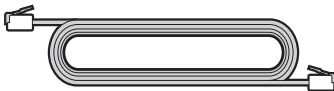

Telephone Line Cord



Quick Reference Guide



Owner's Manual

## The Handset Layout

---

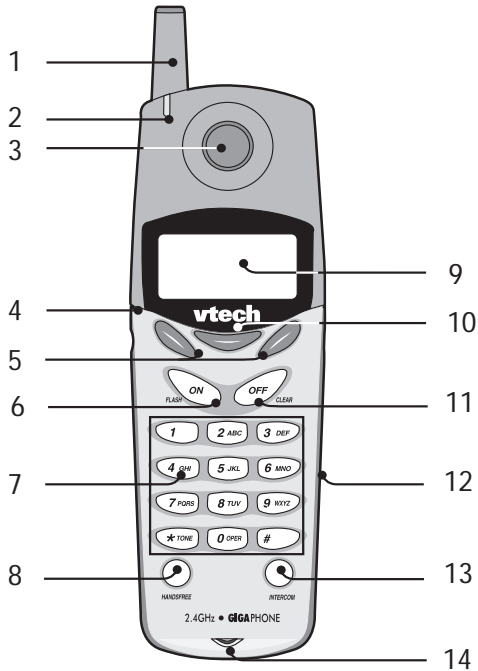

- |                              |                           |
|------------------------------|---------------------------|
| 1. Antenna                   | 8. Handsfree Speakerphone |
| 2. Message Waiting Indicator | 9. LCD Display            |
| 3. Earpiece                  | 10. Select                |
| 4. Headset Jack (2.5mm)      | 11. Off (Clear)           |
| 5. Scroll Keys               | 12. Battery Compartment   |
| 6. On (Flash)                | 13. Intercom              |
| 7. Dialing Key (0-9)         | 14. Microphone            |

# The Base Unit Layout

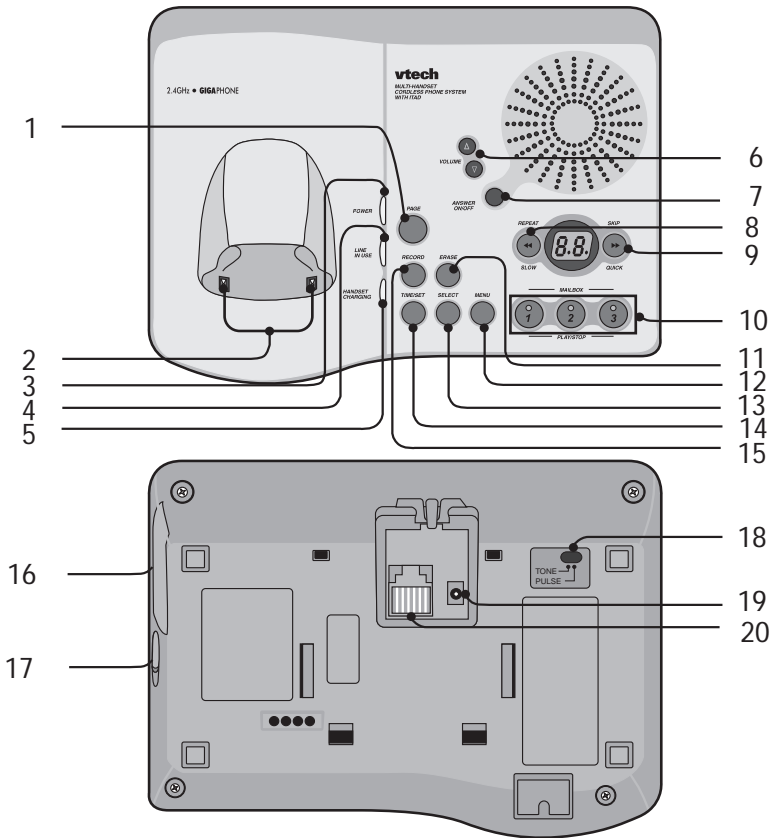

- |                          |                           |
|--------------------------|---------------------------|
| 1. Page                  | 11. Erase                 |
| 2. Charging Contacts     | 12. Menu                  |
| 3. Power Indicator       | 13. Select                |
| 4. Line In Use Indicator | 14. Time/Set              |
| 5. Charge Indicator      | 15. Record                |
| 6. Volume Keys           | 16. Spare Battery drawer  |
| 7. Answer ON/OFF Key     | 17. Spare Battery Release |
| 8. Repeat/Slow Key       | 18. Tone/Pulse            |
| 9. Skip/Quick Key        | 19. DC Connector          |
| 10. MailBox Keys         | 20. Telephone Jack        |

1. Plug the AC power adapter into an electrical outlet, and the DC connector into the back of the base unit.

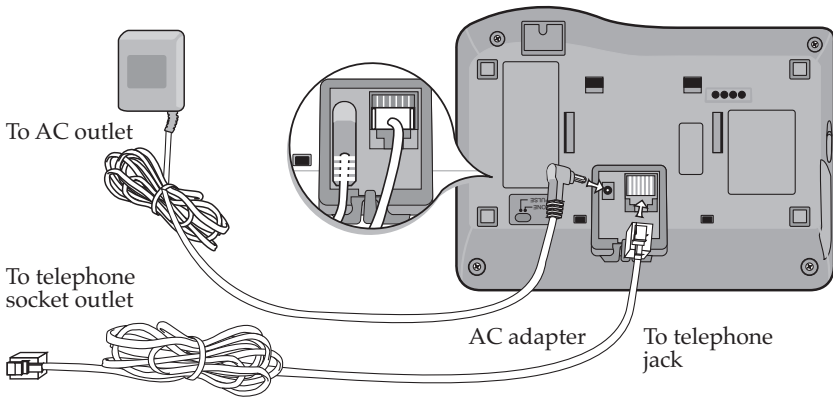

### Connecting to phone line

Plug one end of the telephone line cord into the jack on the back of the base unit. Plug the other end of this cord into the wall jack.

### Checking for dial tone

After the battery is charged press **ON** on the Handset. The Phone icon  will appear on the handset display, and you will hear dial tone. If not, see In Case of Difficulty.

### Tone/Pulse selection

The TONE/PULSE switch is located on the bottom of the Base Unit and factory set to TONE. If you have touch tone service, do not change the switch setting. If you have rotary (Pulse) service, set the switch to PULSE.

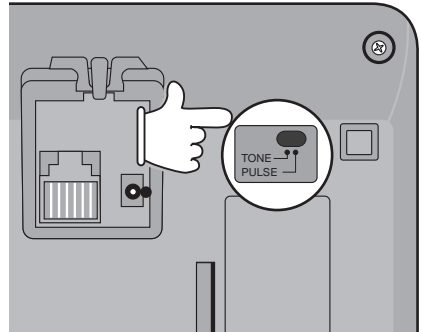

**⚠ CAUTION:** Use only the Vtech power supply provided with your VTECH.

#### **IMPORTANT:**

For best performance the GIGAPHONE should be installed as follows:

In an elevated location, in the center of the room, with no obstructions nearby.

In a location that is away from other electrical appliances such as microwave ovens, personal computers, or televisions.

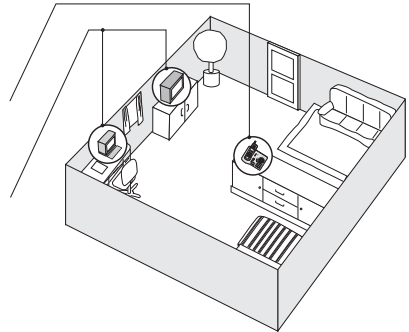

## Installation of Battery Pack in Handset

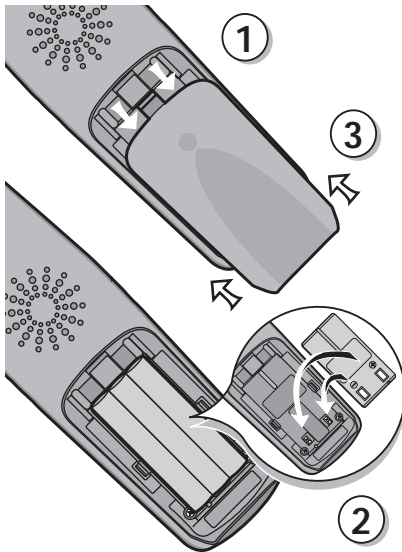

Follow the steps below:

1. Remove the battery cover by pressing on the indent and sliding downward.
2. Place the new battery pack in the handset with the metal contacts aligned with the charge contacts in the battery compartment.
3. Replace the battery cover by sliding it upwards.
4. If the new battery pack is not already charged, place the handset in the base unit, or a remote charging stand, and allow it to charge for 12 hours. After initial charge, a maintenance charge of 8 hours should be sufficient.

The original Handset that is shipped with your GIGAPHONE system will be automatically registered to the Base. This Handset is **HANDSET 1**.

As you register additional Handsets to the system, they will be assigned extension numbers in the following order: **HANDSET 2**, **HANDSET 3**, and finally **HANDSET 4**.

Whenever a Handset battery pack is installed, the Handset will automatically begin **SEARCHING FOR BASE** (if previously registered), or it will prompt you to **ENTER BASE ID** to register the new Handset.

## Spare Battery Charger/Power Backup Function

The GIGAPHONE uses the spare battery charger in the Base Unit. To provide operational backup in the event of a power failure with the a fully charged battery pack in the spare battery charger, you will still be able to place a receive calls from the handset for up to 5 hours.

The spare battery pack can also be used to replace a drained handset battery, ensuring uninterrupted use.

### NOTE :

When using the GIGAPHONE during Power Backup mode, audio quality may be compromised due to reduced Power availability.

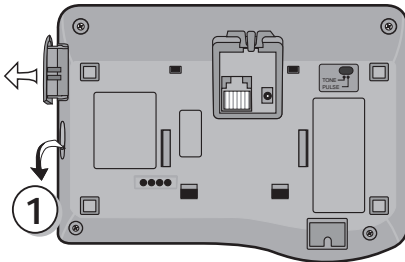

1. Open the spare battery charger by pressing the release button, located on the right-hand side of the Base Unit. A drawer will open to reveal the spare battery compartment.
2. Place a battery pack in the drawer with the charge contacts facing up and to the left.
3. Push the drawer closed.

The spare battery takes 24 hours to fully charge a drained battery.

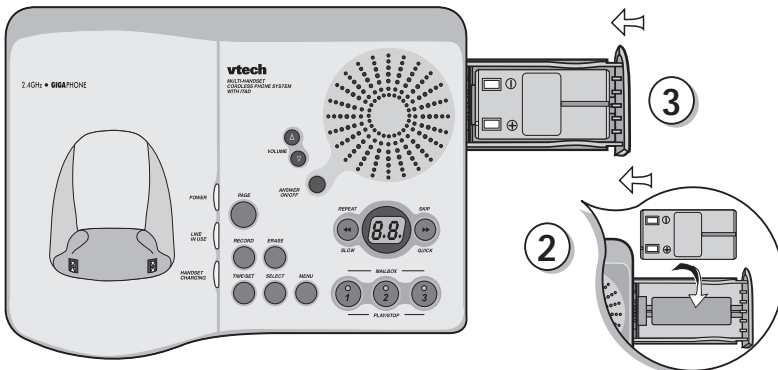

## Charging Of Handset Battery Pack

The Handset of your GIGAPHONE cordless telephone is powered by a rechargeable battery pack. It charges automatically whenever the Handset is in the Base Unit.

**You should charge the battery pack for 12 hours when you first receive your phone.** You'll know the battery pack needs charging when:

- The low battery message is displayed :
- The handset seems completely dead, the LCD is completely clear and does not activate when you press the keys.

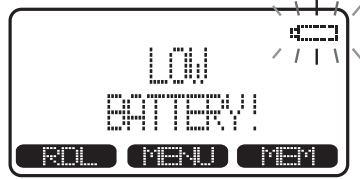

### IMPORTANT:

1. Do not dispose of a battery pack in a fire, the cell may explode.
2. Do not open or mutilate the battery pack. Toxic substances may be released, causing harm to eyes or skin.
3. Exercise care in handling battery packs in order to prevent an accidental short of the charge contacts, potentially causing the battery pack to overheat.
4. Do not dispose of this battery pack into household garbage. Please refer to the following information concerning proper battery recycling:

## Wall Mounting

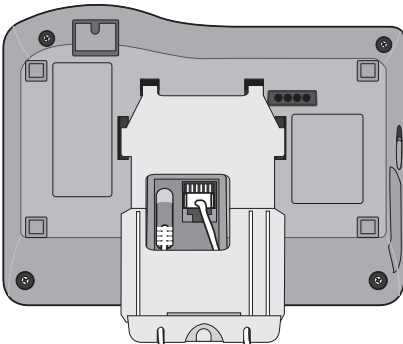
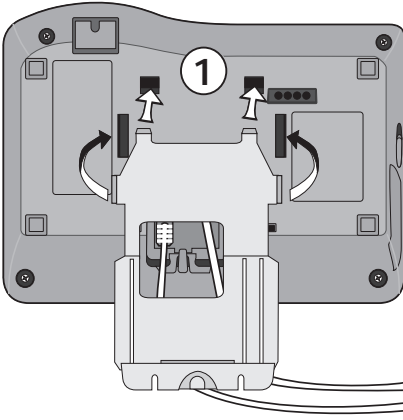

The Wall Mount bracket is designed for use on standard Wall Mount plates only.

1. Line up the tabs on the wall mount adapter with the holes on the bottom of the base unit. Snap the wall mount bracket firmly in place.
2. Plug the AC adapter into an electrical outlet, and the DC connector to the back of the base unit. If the handset battery pack has not been charged previously, place the handset in the base unit cradle, and allow it to charge for 12 hours.
3. Connect the telephone line cord to the jack on the back of the base unit, and the other end to the wall jack.
4. Mount the base unit on the wall. Position the base unit so the mounting studs will fit into the holes on the wall mount bracket. Slide base unit down on the mounting studs until it locks into place.

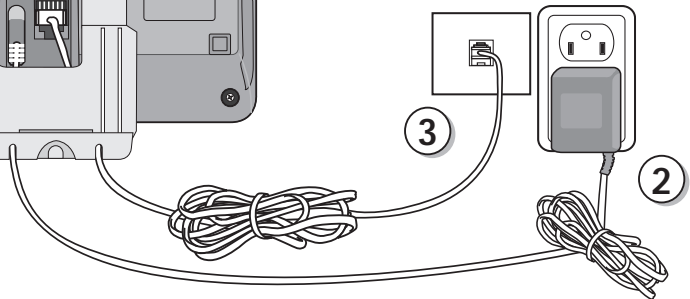

## Registration and Operation

### Registration And Operation Of The VTech VT2420 Accessory Handset

Your VTech GIGAPHONE system can operate up to 4 Handsets.

The VTECH accessory Handset consists of the following:



Handset

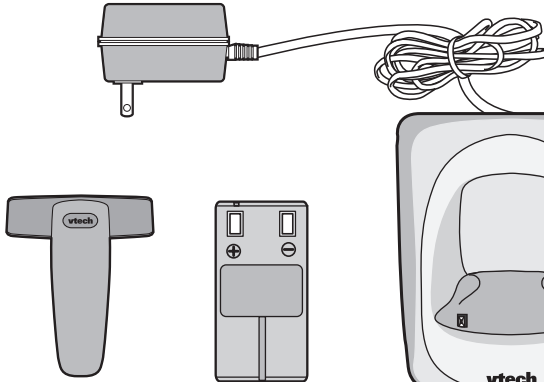

Belt Clip

Battery Pack

Charger Unit

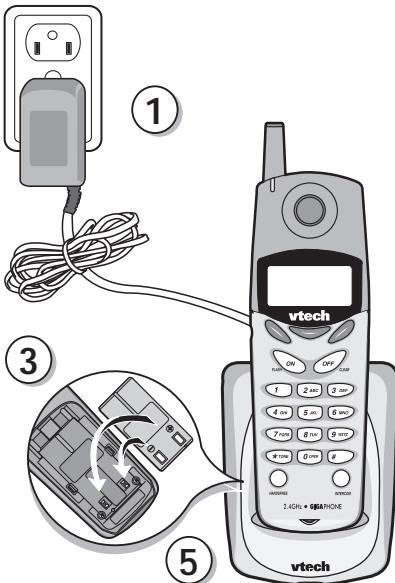

### Setup Of The VT2420 Accessory Handset

1. Plug the AC power adapter into an electrical outlet.
2. Remove the Handset battery cover by pressing on the indent and sliding downward.
3. Place the new battery pack in the Handset, with the metal contacts aligned with the charge contacts in the battery compartment.
4. Replace the battery cover by sliding it upward.
5. Place the Handset in the Charge Cradle, and allow it to charge for 12 hours. After the initial charge, a maintenance charge of 8 hours should be sufficient.

### Enter Base ID Code

1. After charging the Handset, remove it from its Charge Cradle, the screen will display:
2. Press *NEW*, then enter the 15 digit Base Unit ID code, located on the underside of the Base Unit.
3. Press *OK*. The Handset will display: **PLEASE WAIT!!**
4. Wait approximately 15 seconds. The Handset will display:  
**FOUND BASE**





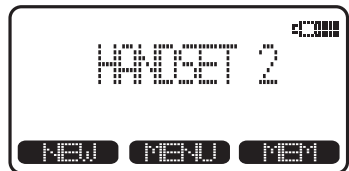
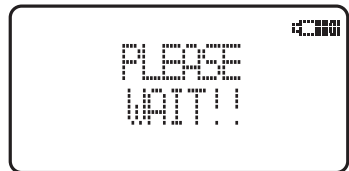
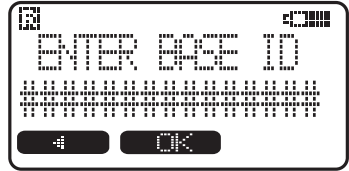
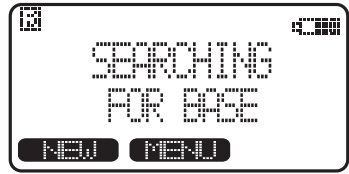

If the Handset displays: **BASE BUSY TRY LATER**, this indicates that the system is in use. Wait until the Base Unit is in the idle (on hook) mode, and repeat step 2 to 4.

Congratulations! You can now enjoy the benefits of your VTECH multi-Handset system.



## Handset and Base Indicators

### Handset Icons

| Icon  | Description  |
|---|--|
|  | <p><u>Line In Use indicator</u><br/>On steady with no number next to it when a parallel set is in use.<br/>On steady with one or more numbers next to it, indicating which extensions are using the line. For example,  12 indicates that Handset 1 and Handset 2 are on an outside call.</p> |
|  | <p><u>Intercom indicator</u><br/>On steady with the extension numbers currently on an intercom call. For example,  02 indicates that the Base and Handset 2 are on an intercom call.</p>  |
|  | <p><u>Battery indicator</u><br/>Cycles (Low, Medium, and High) when Handset battery is charging.<br/>Flashes when a low battery condition is detected.</p>   |
| M   | <p><u>Mute indicator</u><br/>On steady when the Handset microphone is muted.</p>   |
| H   | <p><u>Hold indicator</u><br/>On steady when the line is on hold.</p>   |
| R   | <p><u>Handset Registration indicator</u><br/> is displayed when a Handset is either not registered, or is searching for a Base unit.</p>  |

## Handset and Base Indicators

### Handset LEDs

| LED             | Description  |
|-----------------|--|
| Message Waiting | <ul style="list-style-type: none"><li>• Lights to indicate that you have new messages in your voicemail. Service must be subscribed to through your local telephone company.</li></ul> |

### Base LEDs

| LED              | Description  |
|------------------|--|
| Power            | <ul style="list-style-type: none"><li>• Lights when base unit is receiving power from wall outlet.</li><li>• Flashes when unit is in Power Backup mode.</li></ul>  |
| Line In Use      | <ul style="list-style-type: none"><li>• Lights when line is being used by a handset of the GIGAPHONE system.</li><li>• Flashes when another telephone on the same line (parallel extension) is in use.</li></ul> |
| Handset Charging | <ul style="list-style-type: none"><li>• Lights whenever the handset is placed in the base unit charging cradle.</li></ul>  |

The GIGIAPHONE has an advanced design that uses a menu structure and soft keys to access all of the built-in features.

Example of the idle mode display:

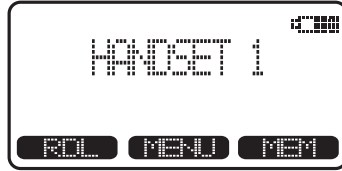

### RDL (Redial)

Press **RDL** to display the last 5 telephone numbers dialed. The number on the top line is the most recent number dialed.

- Use the  scroll keys to select the desired the number.
- To dial the number, you can simply press the *ON* or *HANDSFREE* key.

### MENU

With the Handset in the idle (OFF) mode, press the *MENU* key to access the following options:

- **CALLS LOG (CALLER ID)**
- **HANDSET SETTINGS**
- **REGISTER**

Use the  scroll keys to select the desired option, then press *OK*.

## Calls Log (Caller ID)

From the idle (OFF) mode, press **MENU**, use the  scroll keys to select **CALLS LOG**, then press **OK**. The Caller ID information of the most recently received call will be displayed. For example:



To scroll to other records, use the  scroll keys.

To dial the number displayed, you can simply press the **ON** or **HANDSFREE** key.

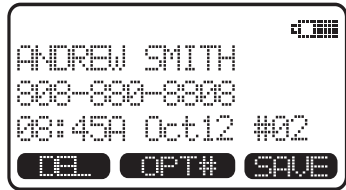

You can also press the **CID** key to access the following options ( **DEL**, **OPT#**, **SAVE**):

- DEL** : Select this option to delete THIS or ALL records in Caller ID memory.
- OPT#** : Select this option to display up to four possible dialing strings of the number stored in Caller ID memory. If a number is provided in the Caller ID data, the possible options to choose from will be either 7, 8, 10, or 11 digits. For example, if the original number in Caller ID memory was 808-880-8808, then the display options will be:

Use the **UP** and **DOWN** keys to make selection, and then press **DIAL**, **ON** or **HANDSFREE** to dial the number.

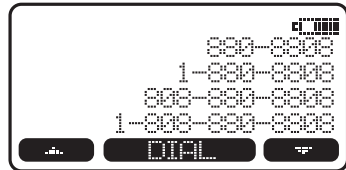

- SAVE** Select this option to save the displayed Caller ID record into Speed Dial Memory. Only Caller ID records with telephone numbers can be saved into Speed Dial Memory. If you need to modify the number after saving, see **TO EDIT A NUMBER**.

### Caller ID - Call Waiting ID

Your GIGAPHONE is capable of displaying the name and/or number of the party calling before you answer the phone (**Caller ID**). It is also capable of displaying Caller ID information in conjunction with a Call Waiting alert signal (**Call Waiting Caller ID**). With Call Waiting Caller ID, the Caller ID data is displayed so you can decide whether to answer the incoming call, or continue with your current conversation.

#### NOTES ABOUT CALLER ID & CALL WAITING CALLER ID

These are subscription services, provided by most regional telephone service providers. You must subscribe to these services to get the benefits of these features. If you do not subscribe to Caller ID services, you can still use your GIGAPHONE and the other features it offers.

Due to regional incompatibilities, Caller ID information may not be available for every call you receive. In addition, the calling party may intentionally block their name and phone number from being sent.

From the Handset Settings menu you can select the following options to modify:

- **RINGER VOLUME**

Select this option to adjust the ringer volume. Use the  scroll keys to adjust the volume up or down. A Handset will display a graphic indicator of the selected volume setting. Press **OK** to confirm your selection and return to the Handset Settings menu.

- **RINGER MELODY**

Select this option to adjust the ringer melody or tone. Use the  scroll keys to select from the six available tones. Press **OK** to confirm your selection and return to the Handset Settings menu.

- **LOW BATT TONE**

Select this option to turn the Low Battery warning tone **ON** or **OFF**. Press the **OFF** or **ON** soft keys, to make your selection. Press **OK** to confirm your selection and return to the Handset Settings menu. When set to **ON**, the Handset will emit a warning tone when a Low Battery condition is detected.

- **RANGE TONE**

Select this option to turn the Out of Range warning tone **ON** or **OFF**. Press the **OFF** or **ON** soft keys, to make your selection. Press **OK** to confirm your selection and return to the Handset Settings menu. When set to **ON**, the Handset will emit a warning tone whenever the Handset is taken out of range of the Base.

- **KEYPAD TONE**

Select this option to turn the Keypad tones **ON** or **OFF**. Press the **OFF** or **ON** soft keys, to make your selection. Press **OK** to confirm your selection and return to the Handset Settings menu. When set to **ON**, the Handset will emit a beep whenever a key is pressed.

- **CONTRAST**

Select this option to adjust the contrast level of the Handset display. Use the  scroll keys to make your selection. The handset display will automatically adjust as you make your selection. Press **OK** to confirm your selection and return to the Handset Settings menu.

- **FACTORY PRESET**

Select this option to restore the factory default settings for the Handset.

Use this option to register a Handset to the GIGAPHONE Base. You can register a total of four Handsets to the GIGAPHONE Base. This process is activated automatically whenever a new handset is powered up in range of the GIGAPHONE Base.

You will be prompted to enter the 15-digit Base ID code printed on the underside of the base unit. After entering this code, press **OK**. The Handset will display **SEARCHING FOR BASE**, and then **FOUND BASE** when the process is complete.

**Note :** Base ID codes are 15 digits long and can include the following characters : 0, 1, 2, 3, 4, 5, 6, 7, 8, 9, **\***, or **#** .

## MEM (Memory)

---

The GIGAPHONE can store up to 50 names/numbers in memory. Each memory location can hold up to 32 digits and up to 16 characters for the name.

When prompted to **ENTER NAME?**, use the digit keys to 'spell' the name. Each press of a particular key causes characters to be displayed in the following order:



| Number Key | Characters (in order) |
|------------|-----------------------|
| 1          | & ' , . 1             |
| 2          | A B C 2               |
| 3          | D E F 3               |
| 4          | G H I 4               |
| 5          | J K L 5               |
| 6          | M N O 6               |
| 7          | P Q R S 7             |
| 8          | T U V 8               |
| 9          | W X Y Z 9             |
| 0          | 0                     |
| *          | *                     |
| #          | #                     |

**To Store a Number/Name:**

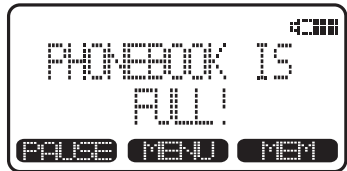
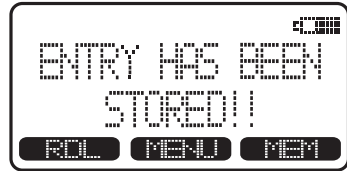
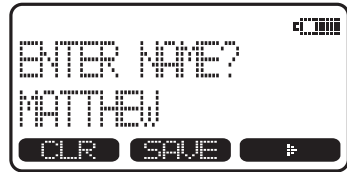
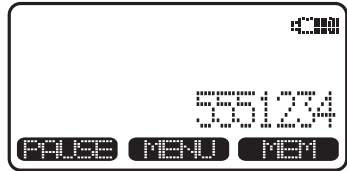
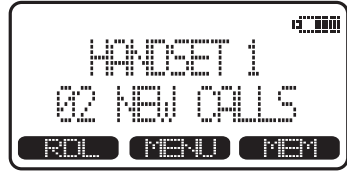
- Starting from the idle screen, enter the number you want to store in memory.
- Be sure to include long distance codes and pauses (using the *PAUSE* softkey) if necessary. Press the *MEM* softkey.
- You will then be prompted to **ENTER NAME?** Use the digit keys to 'spell' the name. If you make a mistake, press the *CLR* softkey. To enter a space press *SPACE*. When finished, press *SAVE*.
- If there is space available in memory, the number/name will be saved and the Handset will return to idle mode.
- If the memory is full the Handset will display **PHONEBOOK IS FULL** and exit to the idle screen without saving the entry.



## To Search For and Dial a Number/Name:

- Starting from the idle screen, press the *MEM* softkey to review memory contents.
- Using the  /  softkeys scroll through the memory contents in alphabetical order.
- Or, you can press the *FIND* softkey, enter the first few characters of the name and then press *FIND* to search. If you make a mistake, press *CLR* softkey. The closest match, in alphabetical order, will be displayed.
- Once you find the entry you want, simply press *ON* or *HANDSFREE* to dial the number.

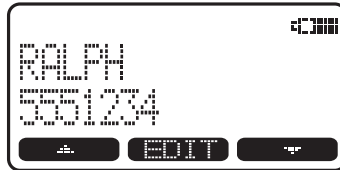
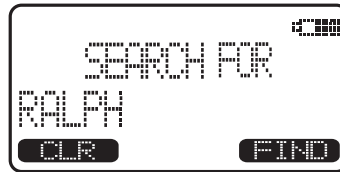
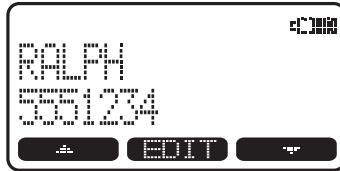

## To Delete a Number/Name:

- Using the steps in **To Search For and Dial a Name/Number**, locate the entry you want to delete.
- Press the *EDIT* softkey. The Handset will display:

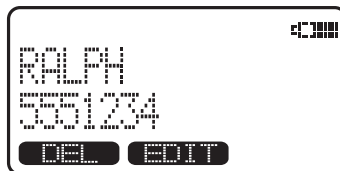
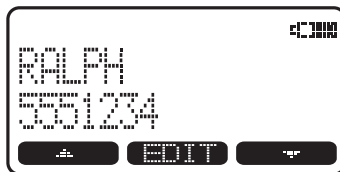

- Press the *DEL* softkey. The Handset will display:
- To delete this record, press *THIS*.
- To confirm the deletion of *ALL* records, press *YES*. To exit without deleting press *NO*.

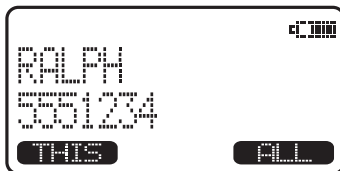

### To Edit a Number

- Using the steps in **To Search For and Dial a Name/Number**, locate the entry you want to edit.
- Press the **EDIT** softkey **twice**. The Handset will display:
- Using the  softkey move the cursor to the character you want to edit and then enter the corrections as needed. Press **MORE** to access **DEL**, **BACK** and **PAUSE** function. When finished press the **SAVE** softkey. To exit without saving press **OFF**.
- When finished the handset will display the edited entry.

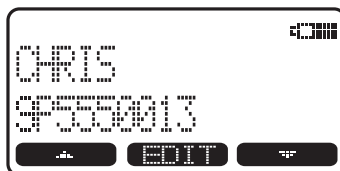
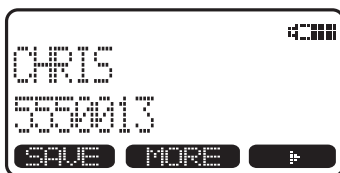
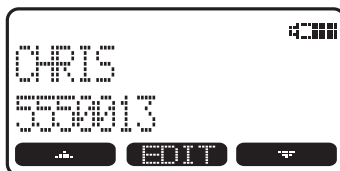

# Handset and Base Operation

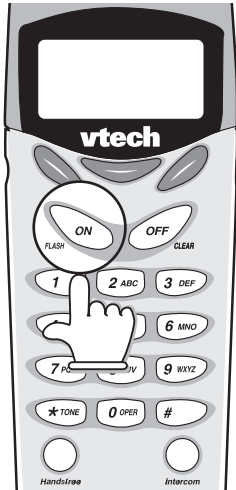

## Making Calls

### From the Handset



- Press **ON** (or, **HANDSFREE** to use the Handset Speakerphone feature). Dial the phone number.

-OR-

- Dial the phone number first; then press **ON** (or **HANDSFREE**).
- Press **OFF** to end your call.

## Answering Calls

### From the Handset



- Press any key except **OFF** or the softkey.
- Press **OFF** to end your call.

## Mute Function

During an active call pressing either the **MUTE** soft key on the Handset, will disable the microphone. Press **MUTE** key again to return to normal 2-way conversation.

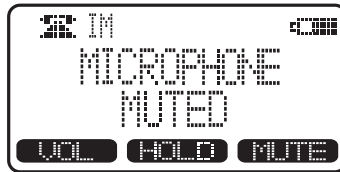

## Hold Function

From the Handset :

- Press the **HOLD** soft key to place a call on hold. To return to the call press the **ON** or **HANDSFREE** key.

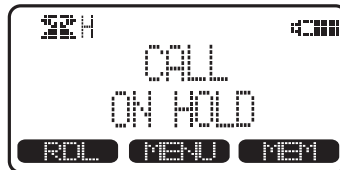

# Handset and Base Operation

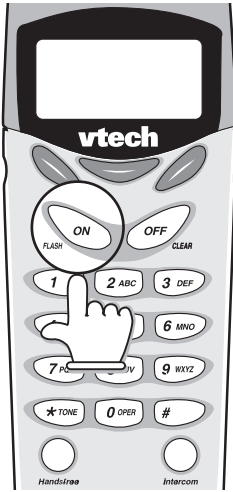

## Flash Function



You can use your GIGAPHONE with services such as Call Waiting. Simply press the **ON** key on the Handset to **FLASH** the line.

## Volume Control

From the Handset :  
During an active call press the **VOLUME** soft key, then use the **UP** and **DOWN** soft keys to adjust the earpiece volume.

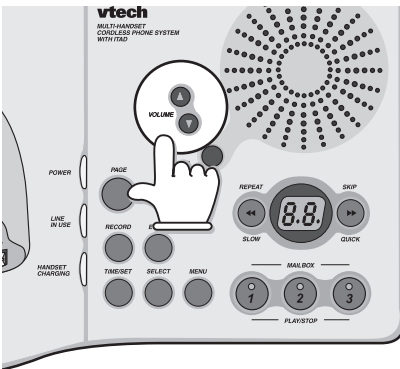
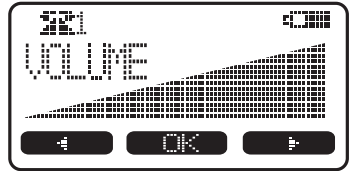

From the Base :  
During an active call simply press the Volume **UP** or **DOWN** keys to adjust the speakerphone volume.

# Handset and Base Operation

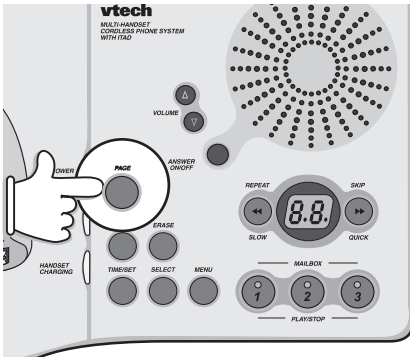

## Page



From Base to ALL Handsets :

- To page all Handsets from the Base press the **PAGE** key. This will cause all Handsets linked with this Base to ring.
- Each Handset will display **PAGE FROM BASE**.
- To end an **PAGE** call, press **OFF** on the Handset or **PAGE** on the Base.

From Handset to Handset :

- Press the **INTERCOM** key followed by the number of the other Handset you wish to call (e.g. **INTERCOM 3**).
- Handset 3 can then answer the intercom call by pressing the **INTERCOM** key.
- To end the intercom call press **OFF** on either Handset.

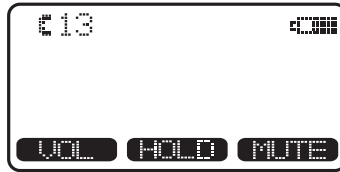

All Call from Handset

- Press the **INTERCOM** key followed by the **\***. All registered Handsets and the Base will ring.
- Any Handset or the Base can answer by pressing **INTERCOM**.
- To end the intercom call press **OFF** on Handset, or press **PAGE/INTERCOM** on Base.

## Handsfree Speakerphone Operation

Your GIGAPHONE handset has a built-in handsfree speakerphone. This feature allows you to stand the Handset upright on a table or desktop and have handsfree conversations. For more information, refer to **MAKING CALLS in HANDSET AND BASE OPERATION**.

### Line in Use Indication

On the Handset :

When the telephone line is currently being used by a GIGAPHONE Handset or the GIGAPHONE Base, a status message similar to this will display on idle Handset(s):

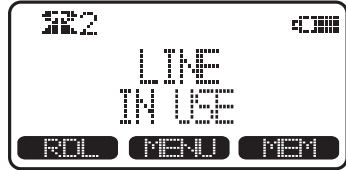

When the telephone line is currently being used by a parallel set (a telephone device other than the GIGAPHONE on the same line); the phone icon will remain on steadily, and EXTENSION IN USE will be displayed.

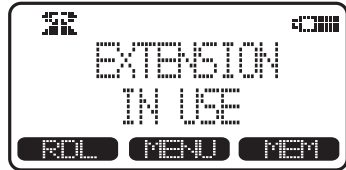

On the Base :

When a GIGAPHONE Handset or a GIGAPHONE Base is currently being used, the LINE IN USE LED on the base will illuminate steadily. When a parallel set is currently being used, the LINE IN USE LED on the base will flash.

### Low Battery Indication

When a low battery is detected, the Battery icon will flash and a warning beep is played. The status message LOW BATTERY will also be displayed when the Handset is in idle mode. To prevent an unexpected call drop, a drained Handset battery should be replaced by a fully charged spare battery.

### Message Waiting Indication

The GIGAPHONE is compatible with optional voicemail service provided by some local telephone companies. If you subscribe to this service, and you have new, unplayed messages in your voicemail, a Visual Message Waiting Indicator (VMWI) signal is transmitted by your local telephone company.

The GIGAPHONE will detect a VMWI signal and activate a the Message Waiting light on the Handset.

After you check your messages, the Message Waiting indicators will automatically turn off.

Please note that whenever new, unplayed messages are stored in your voicemail, the local Telephone Company will continue to send a VMWI signal.

## Conference Calling

The GIGAPHONE is capable of supporting conference calls with up to two registered Handsets.

To enter a conference call, simply access the line with two or more extensions by pressing *ON* (or *HANDSFREE*) on the Handset.

The phone icon  and two or more extension numbers will be displayed in the upper left corner of the Handset.

## Transferring Calls

You can transfer calls on the GIGAPHONE system from Handset to Handset.

### Blind Transfer

You can directly transfer any active call to another GIGAPHONE extension without notification by doing the following steps:

- Handset must be on an active call.
- Press the *INTERCOM* key followed by the number of the Handset (*1,2,3,4*) that you wish to transfer the call to.
- When the other extension answers, the call will automatically be connected to the other extension.
- An unanswered call will ring back to the originating Handset if not answered within 30 seconds

### Announced Transfer:

You can perform an announced transfer (call and advise another extension) of an active call by doing the following steps:

- Handset or Base must be on an active call.
- Place the active call on *HOLD*.
- Press the *INTERCOM* key followed by the number of the Handset (*1,2,3,4*) or Base (*0*) that you wish to transfer the call to.
- When the other extension answers the intercom call, explain they have an active call waiting.
- Both extensions press *OFF* to end the intercom call.
- The other extension presses *ON*, *HANDSFREE*, or *SPEAKERPHONE* to pick up the call on hold.

## Answering System Programming Overview

Setup order for the Answering System is :

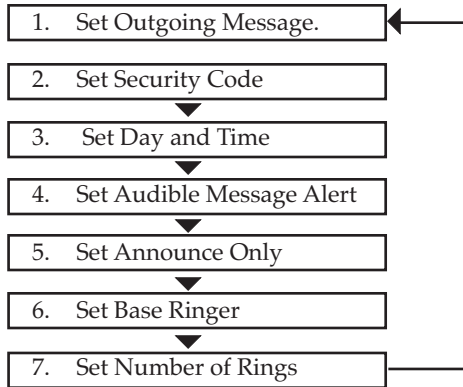

During Answering System setup, the display will flash "--". If no key is pressed for 20 seconds, the Answering System will beep, and exit program mode. You can also exit program mode at any time by pressing any **MAILBOX** key.

## Set Outgoing Message (OGM)

### Selecting Announcement

There are 2 choices of announcements:

Normal outgoing message & Outgoing message for Announce Only.

#### 1. Normal answering mode.(Announce Only:OFF)

In this mode, the caller is able to leave his message. If no announcement is recorded, the default announcement "Hello, I'm unable to answer your call right now. Please leave your name, number and message after the tone." will be used. (see **Recording the OGM**).

#### 2. Announce Only mode

If this mode is set, the caller is not able to leave his message. If no announcement is recorded, the factory default greeting is: "Hello, I'm unable to answer your call right now. Please call again.Thank you." will be used.(see **Recording the OGM**)

Example for OGM1 (for multi - user application):

"Hi! We can't come to the phone right now. If you have a message for John press \* 1 ('Star 1'), for Jane press \* 2 ('Star 2'), for Jack press 3 \* ('Star 3'). Or, just stay on the line and record after the beep. Thank you."

Example for OGM2 (Announce Only):

"Hi! You have reached Jack and Jill. We will be back after 1 p.m. Please call back then. Thank you."

# Answering System Setup

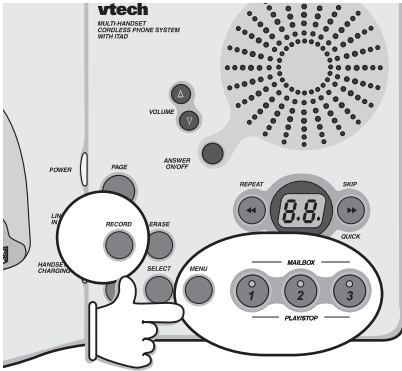

## NOTE:

In Announce Only mode, your outgoing announcement is repeated before hanging up.

## Recording / Playing / Deleting the Outgoing Messages (OGM)

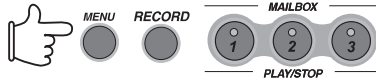

1. Press **MENU** key until the desired item (Set Outgoing Message) is announced.
2. Press **RECORD**. "Now recording", is announced, followed by a beep. Speak towards the front of the Answering System (max. length: 90 seconds).
3. Press any **MAILBOX** key to stop the recording.
4. Then OGM replays the message automatically, followed by a beep.
5. To review a recorded announcement, press **MENU** key until "Set Outgoing Message" is announced. Press any **MAILBOX** key. The current greeting is played.
6. To delete a recorded announcement, press **ERASE** during OGM playback. You then hear "Outgoing Message has been erased".

## NOTE:

If your recording time is less than 2 seconds, your OGM will not be recorded, and the default greeting will be used.

## Set Security Code

The security code programmed into the Answering System is used to gain access to functions from remote locations. The security code default setting is **19**. You can select any two-digit code, from **00** to **99**.

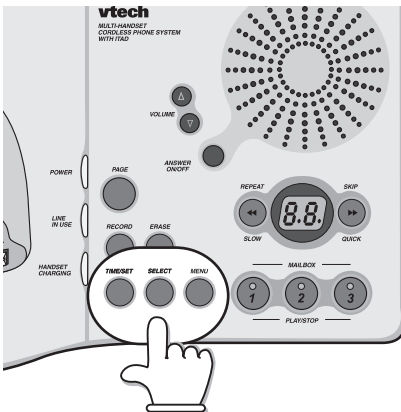

1. Press **MENU** until you hear "Set security code."
2. Press **TIME/SET** to hear the current security code.
3. Press **SELECT** briefly to increase the security code by 1. Or, hold **SELECT** continuously to increase the code by multiples of 10.
4. Press **TIME/SET** to confirm your choice and you will hear the announcement of the security code.

## Day and Time

During initial setup, or after a power failure, the day and time default is set to Monday, 12:00am. The display will flash "CL" to indicate day and time need to be set.

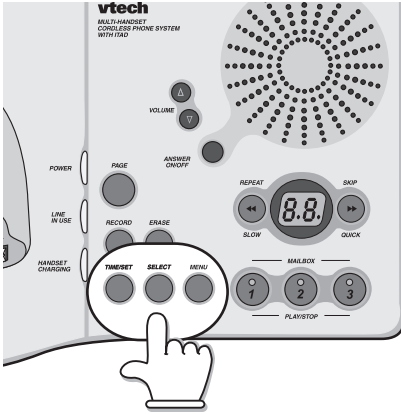

1. Press **MENU** until you hear, "Set day and time."
2. Press **SELECT** until the correct day is announced.
3. Press **TIME/SET** to confirm your choice.
4. Press **SELECT** until the correct hour is announced.
5. Press **TIME/SET** to confirm your choice.
6. Press **SELECT** until the correct minute is announced. Holding the key continuously will increase the minutes by 10 minute steps.
7. Press **TIME/SET** to confirm your choice. You will hear an announcement of the day and time.

## Set Audible Message Alert

If you want your Answering System to beep once every 10 seconds to notify you when new messages have been received, set Audible Message Alert to ON. Otherwise, it is preset to OFF.

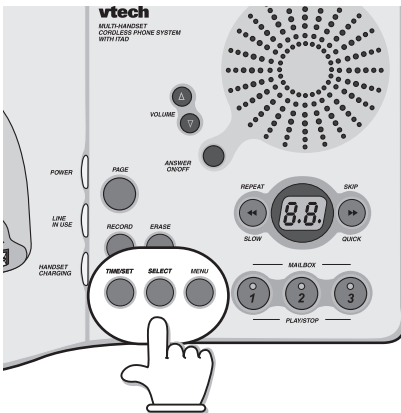

1. Press **MENU** until you hear "Set Audible Message Alert."
2. Press **SELECT** until the desired setting, (ON or OFF) is announced.
3. Press **TIME/SET** to confirm your choice. The voice prompt of "Audible Message Alert On" or "Audible Message Alert Off" will be heard.

# Answering System Setup

## Set Announce Only

### CAUTION:

If you turn on the Announce Only option, your callers cannot leave a message.

1. Press **MENU** until "Set Announce Only" is announced.
2. Press **SELECT** until desired setting "ON" or "OFF" is declared.
3. Press **TIME/SET** to confirm, and the setting will be announced.

**Note:** You can store one OGM for Announce Only mode, and a separate OGM for Normal (accept messages) mode. The appropriate OGM will be played based on how you set Announce Only.

## Set Base Ringer On/Off

The Base ringer can be turned on or off.

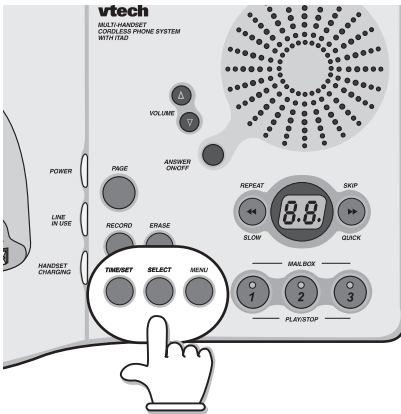

1. Press **MENU** until you hear "Set Base Ringer"
2. Press **SELECT** to toggle between the choices (ON or OFF).
3. Press **TIME/SET** to confirm your selection. Voice prompt of "Base Ringer is on" or "Base Ringer is off" will be announced to confirm your setting.

## Set Number of Rings



The Answering System has 4 ring type settings:

- 2 rings** The incoming call is answered after 2 rings.
- 4 rings** The incoming call is answered after 4 rings.
- 6 rings** The incoming call is answered after 6 rings.

## Toll Saver

The incoming call is answered after 2 rings only if there are new messages/memos present. Otherwise, the call is answered after 4 rings. This may help you avoid long distance charges when retrieving messages remotely.

1. Press **MENU** until you hear "Set number of rings."
2. Press **SELECT** until you hear the desired setting "2", "4", "6", or "Toll Saver".
3. Press **TIME/SET** to confirm your choice. The selected setting is then announced.

# Answering System Operations

## Leaving a Message (Incoming Message)

The Answering System will answer a call (according to the current ring selection), then play the OGM, followed by a beep to signal the start of recording.

- Default mailbox is MAILBOX 1.
- If you want to record the incoming message in specific mailbox, press " \* x" ( \* 1, \* 2 or \* 3) during OGM playback.
- After desired mailbox is selected, "Mailbox X, now recording" will be announced, and incoming message recording starts after a beep.
- If incoming message length is less than 2 seconds, message will not be recorded. An incoming message can be a maximum of 4 minutes.

## Listening to Messages / Memos

When new messages and/or new memos are left, the display will flash the total number of new messages in all mailboxes.

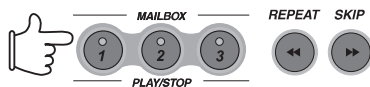
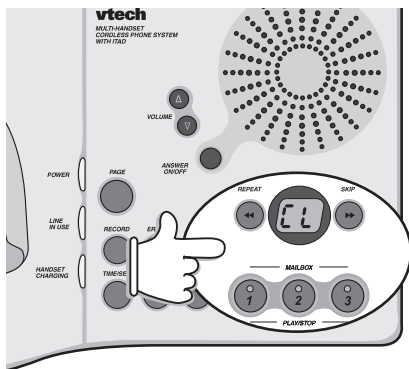

- Press the desired Mailbox key to hear messages.
- The system will announce "Mailbox X, you have x new message(s) and x old message(s)" in the presence of new message in corresponding mailbox. Then the system will play only the new messages.
- In the absence of new messages, the system will announce "Mailbox x, you have x old messages" and then playback the old messages.
- The **▶▶** and **◀◀** keys can be used to skip forward and backward during message playback.
- To stop message playback, and return to normal operation mode, press any MAILBOX key.
- The day and time stamp is announced after each message is played.
- After all messages and memos have been played, the final voice prompt will be, "End of messages", and the Answering System will exit playback mode.
- Note that the system will play the message based on "First-In-First-Out"
- If the system has less than 5 minutes recording time left, it will announce the remaining recording time to alert the user.
- During message playback, the display will be flashing to indicate that the currently playing message is a new message.

# Answering System Operations

## Saving Messages

- The Answering System will automatically save your messages if you do not delete them. The messages will be retained even after power failure.
- The system can record up to 15 minutes of messages.

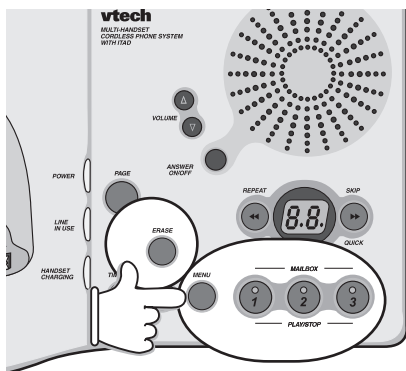

## Deleting Messages



Press **ERASE** at any time during message playback to delete the current message.

All old messages for a particular mailbox, can be deleted by pressing and holding the **ERASE** key for more than 2 seconds. The system will announce "Please select mailbox".

Press the **Mailbox X** key to delete all the old messages in the selected mailbox.

### NOTE:

The **ERASE** function will only delete old messages. New messages **CANNOT** be deleted until they are reviewed.

## Turning the Answering Machine ON/OFF

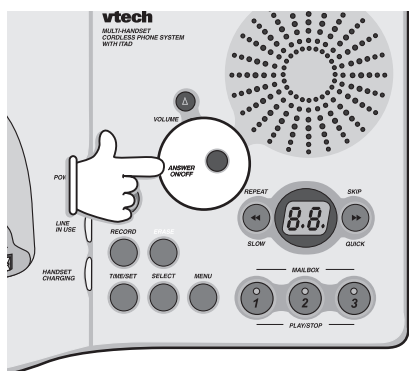

- If you want the Answering System to answer calls, press **ANSWER ON/OFF**. The BACKLITE LED will then be turned on, and "Answering machine on" will be announced.
- If you don't want the Answering System to answer calls, press **ANSWER ON/OFF**. The BACKLITE LED will then be turned off and "Answering machine off" will be announced.
- The display will still show the number for new messages.
- Even if the Answering System is set to OFF, it will still answer calls after 10 rings. An announcement, "Please enter your security code" is given, and you can enter your security code to use remote operation. (See **Remote Operation of Answering System**)

# Answering System Operations

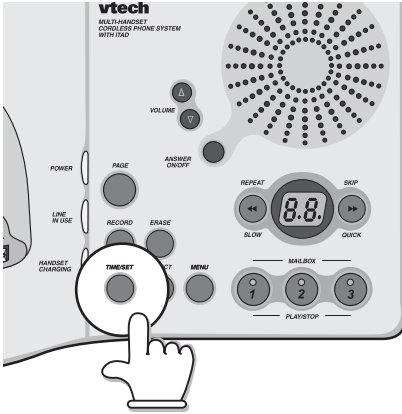

## Check Current Day and Time



You can check the current day and time by pressing **TIME/SET**. After the announcement, the Answering System will generate a beep.

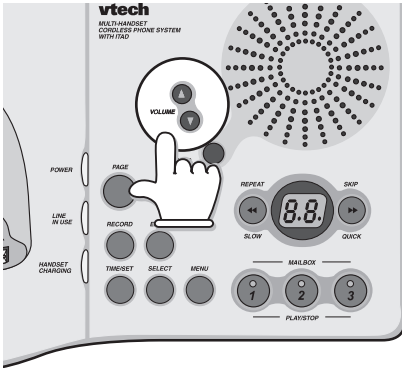

## Changing Speaker Volume



If you prefer to not hear messages while your callers leave them (call screening), set the volume to the minimum level (1). Press the **▲** and **▼** keys for the desired volume level. There are 8 volume levels.

If volume is set at maximum or minimum level, further pressing of the volume keys will give 3 short beep tones.

Volume changes continuously if the Volume UP/DOWN is held.

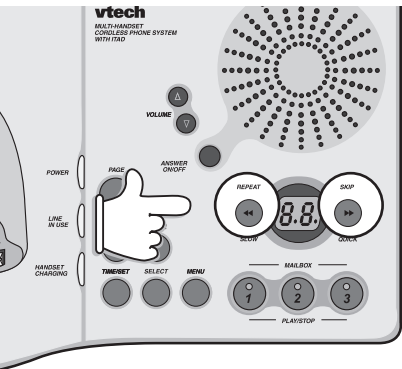

## Changing Playback Speed

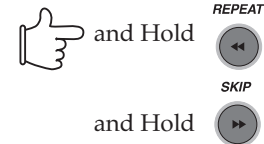

During playback, you can change the playback speed by simply holding down **◀◀** (SLOW) or **▶▶** (QUICK) to the desired speed during playback. There are 3 playback speeds (SLOW / NORMAL / QUICK). The default speed is normal. Playback speed will return to normal once you release the **◀◀** or **▶▶** Key.

# Answering System Operations

## Auto Disconnect for Extension Phone Pick-up

The Answering System will auto-disconnect the telephone line if an extension phone or the cordless Handset accesses the line.

## Memory Full

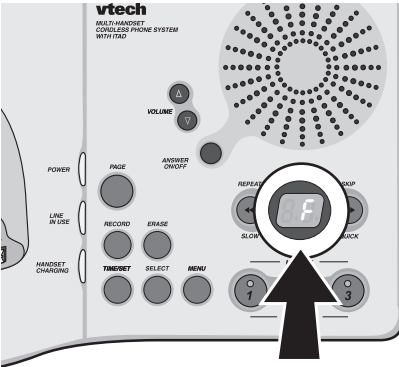

- When the Answering System has less than 30 seconds recording time remaining, or the total number of messages equal 99, the display shows "F" with the number of new messages to indicate memory full.
- If the Answering System memory is full, it will automatically default to Answering System OFF mode. The Answering System will answer a call after 10 rings and "Memory full, Please enter your security code" is announced. You may enter remote operation mode by entering the security code.
- If memory is full, any attempt to record memos or OGM's will be ignored.

## Power Failure

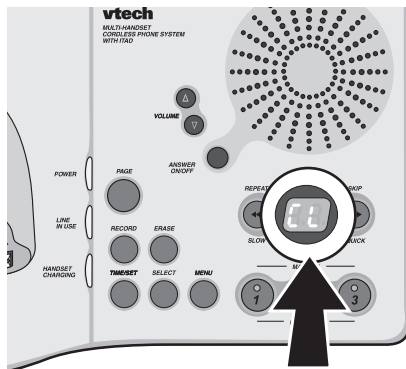

- After a power failure, "CL" will flash to notify you to set the day and time.
- All the messages, OGM's and menu settings (other than day and time) will be retained.
- The Answering System will default to ANSWER ON.
- Note that after power up, the Answering System may have an initialization period, during which, the display will flash with "--". During this period, you can still use the cordless phone.

## Answering System Operations

---

### BASE UNIT MESSAGE WINDOW (LED)

- The large Base Unit LED provides useful data on the status of your VT 2461 answering device. Below are examples of the LED data:

| <b>The LED displays:</b> | <b>What it means</b>                                   |
|--------------------------|--|
| Flashing number          | You have that amount of new messages                   |
| 0                        | You have no new messages                               |
| CL flashing              | The clock needs to be set                              |
| A                        | Answering System is in Announce-Only mode              |
| F flashing               | Answering System memory is full                        |
| 99 flashing              | Recording time has exceeded 99 seconds                 |
| 1-8                      | Volume level as you're setting it.                     |
| --                       | Answering System is answering a call or in remote mode |
| -- flashing              | Answering System is in programming mode                |

# Remote Operation Of Answering System

---

Remote operation allows you to control the functions of the Answering System when you are away from the Base, and call from an outside telephone line. The Answering System cannot be accessed from another telephone on the same line. You can access many of the Answering System functions from a remote location, such as listening to messages, changing recorded announcements, and recording memos.

Remote operation can only be accessed from a touch tone telephone. If the remote phone is set to pulse dialing, switch it tone. If tone dialing is not available, you will not be able to access the Answering System.

**Note:** All function codes should be entered within 2 seconds in order to activate Remote Operation.

## To Activate Remote Operation From a Different Telephone Line

1. If the Answering System is **OFF**, you can dial your telephone number and wait for the Answering System to answer your call after 10 rings. An announcement, "Please enter your security code" is given, and you enter your security code to use remote operation.
2. If the Answering System is **ON**, it will answer your call and begin playing the currently selected announcement (as with any incoming call).
3. Enter "# " followed by your 2 digit security code during the announcement. The default security code is 19.
4. Once the security code is received, a double confirmation beep will be given, and you are in Remote Operation mode. You can then control the Answering Machine functions using the telephone keypad.
5. The user can also enter the Remote Operation mode during message recording. The procedure is the same as step 3. The recording will be stopped after entering the valid security code "#xx" and the incomplete message will be deleted. If "★0" is entered, the Answering System will release the line, but the recorded message will still be retained.
6. If the user enters a wrong security code, the system will release the line.

## Playing Messages Remotely

1. Press "#1", "#2" or "#3" on the touch tone keypad to play the messages in the corresponding mailbox.
2. The system will announce "Mailbox X. You have XX new messages and XX old messages" and the system will playback the new message only. If there are no new messages, the system will announce "Mailbox X. You have XX old messages. On the other hand, in the absence of old messages, the system will announce only the number of new messages.

## Repeat Messages During Playback

1. Press "#4" once during message playback to repeat the current message.
2. Press "#4" twice within 2 seconds to skip to the previous message.

# Remote Operation Of Answering System

---

## Skip Messages During Playback

1. Press "#6" once to skip forward to the next message.

## Stop Message Playback

1. Pressing "#5" during message playback will stop playback.

## Deleting Messages

1. Press "#9" once during message playback to delete the current message.

**Note:** Playback will pause if "#" or "★" is entered. Answering System will wait for the command in the following 2 seconds. If no further tone is entered, playback will be resumed.

## Memo Recording

1. Press "★ 8".
2. After selecting the mailbox by entering command "1", "2", "3", You will hear, "Now recording", followed by a beep.
3. Enter "#5" to stop recording when you have finished.

## Change OGM Remotely

1. Enter "★7" to record a new OGM. You will hear, "Now recording", followed by a beep to signal start of recording.
2. Press "#5" to stop recording. Your new OGM will playback automatically.

## Check OGM1 Remotely

Enter "#7" to review OGM. You will hear playback of OGM followed by a beep.

## Turning Answering System ON or OFF

Pressing "#0" toggles the Answering System ON/OFF. "Answer machine on", or "Answer machine off" will be announced, followed by a beep.

# Remote Operation Of Answering System

---

## Voice Menu for Remote Operation

The system provides two pre-recorded voice menus to help you during remote operation. Press "**\* 5**", and you will hear the simple voice menu.

The simple voice menu is as follows:

Press "**#1**" to play mailbox 1.  
Press "**#2**" to play mailbox 2.  
Press "**#3**" to play mailbox 3.  
Press "**#5**" to stop.  
Press "**#4**" to repeat the message.  
Press "**#6**" to skip the message.  
Press "**#9**" to erase the message.  
Press "**\* 5**" for other functions.  
(To the advanced voice menu)

The advanced voice menu is as follows:

Press "**#7**" to review outgoing message.  
Press "**\* 7**" to record outgoing message.  
Press "**\* 8**" to record memo.  
Press "**#4**" twice to repeat previous message.  
Press "**#0**" to turn the system on or off.  
Press "**\* 5**" to return to the simple voice menu.

Pressing any function code will stop the voice menu, and perform the corresponding functions.

## Exiting Remote Operation

1. Enter "**\* 0**" on the touch tone keypad to exit remote operation mode. The Answering System confirms your action with a long beep and then disconnects.
2. The Answering System also automatically disconnects if no key is pressed within 20 seconds during remote operation.

## Headset Operation

Your GIGAPHONE cordless telephone is equipped with a 2.5mm Headset Jack for use with an optional accessory Headset for hands-free operation. If you choose to use the Headset option, you must obtain an optional accessory Headset, which is compatible with the GIGAPHONE.

**To purchase a Headset, call VTECH Customer Service at 1-800-595-9511.**

Once you have a compatible 2.5mm Headset, locate the Headset Jack on the GIGAPHONE Handset. Connect the plug on the Headset cord to the jack on the cordless Handset. The plug should fit securely. Do not force the connection.



### Operation

#### NOTE :

Whenever a compatible Headset is connected to the cordless Handset, the microphone on the Handset will be muted. This is done to limit the effect of background noise.

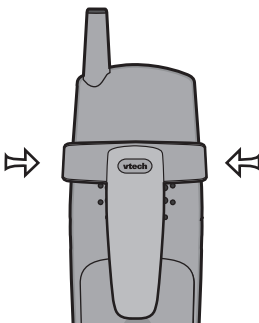

### Belt Clip

The GIGAPHONE is also equipped with a detachable belt clip. Align the pins on the inside edge of the clip with the notches on the sides of the GIGAPHONE Handset. The belt clip should snap securely into place. Do not force the connection.

### Taking Care Of Your Telephone

Your GIGAPHONE cordless telephone contains sophisticated electronic parts, so it must be treated with care.

#### Avoid rough treatment

Place the Handset down gently. Save the original packing materials to protect your telephone if you ever need to ship it.

#### Avoid water

Your telephone can be damaged if it gets wet. Do not use the Handset outdoors in the rain, or handle it with wet hands. Do not install your Base Unit near a sink, bathtub or shower.

#### Electrical storms

Electrical storms can sometimes cause power surges harmful to electronic equipment.

For your own safety, use caution when using electric appliances during storms.

#### Cleaning your telephone

Your telephone has a durable plastic casing that should retain its luster for many years. Clean it only with a soft cloth slightly dampened with water or a mild soap. Do not use excess water or cleaning solvents of any kind.

Remember that electrical appliances can cause serious injury if used when you are wet or standing in water. If your Base Unit should fall into water, **DO NOT RETRIEVE IT UNTIL YOU UNPLUG THE POWER CORD AND TELEPHONE LINE CORDS FROM THE WALL.** Then pull the unit out by the unplugged cords.

## In Case Of Difficulty

---

If you have difficulty operating your phone, the suggestions below should solve the problem. If you still have difficulty after trying these suggestions, call VTECH Communications at 1-800-595-9511. In Canada, call VTECH Electronics at 1-800-267-7377.

### The Phone Doesn't Work At All

- Make sure the Power Cord is plugged in.
- Make sure the telephone line cord is plugged firmly into the Base Unit and the telephone wall jack.
- Make sure the batteries are properly charged. If the 'LOW BATTERY' message is shown, the battery pack needs charging.

### No Dial Tone

- First check all the suggestions above.
- If you still don't hear a dial tone, disconnect the Base Unit from the telephone jack and connect a different phone. If there is no dial tone on that phone either, the problem is in your wiring or local service. Contact your local telephone company.

### You Get Noise, Static, Or A Weak Signal Even When You're Near The Base Unit

- Household appliances plugged into the same circuit as the Base Unit can sometimes cause interference. Try moving the appliance or the Base Unit to another outlet.

### You Get Noise, Static, Or A Weak Signal When You're Away From The Base Unit

- You may be out of range. Either move closer to the Base, or relocate the Base Unit.
- The layout of your home may be limiting the range. Try moving the Base Unit to another position.

### The Handset Does Not Ring When You Receive A Call

- Make sure you have the Handset ringer activated. To set the ringer, see **HANDSET SETTINGS** and **BASE SETTINGS**.
- Make sure the telephone line cord is plugged firmly into the Base Unit and the telephone jack. Make sure the power cord is plugged in.
- You may be too far from the Base Unit.
- You may have too many extension phones on your telephone line to allow all of them to ring. Try unplugging some of the other phones.

### You Hear Other Calls While Using Your Phone

- Disconnect your Base Unit from the telephone jack, and plug in a regular telephone. If you still hear other calls, the problem is probably in your wiring or local service. Call your local telephone company.

### You Hear Noise In The Handset, And None Of The Keys Or Buttons Work

- Make sure the power cord is plugged in.

### Common Cure For Electronic Equipment

If the unit does not seem to be responding normally, then try putting the Handset in the cradle. If it does not seem to respond, do the following (in the order listed) :

1. Disconnect the power to the Base.
2. Disconnect the Handset battery, and spare battery pack, if applicable.
3. Wait a few minutes.
4. Connect power to the Base.
5. Re-install the battery pack (s)
6. Watch for Handset to display :

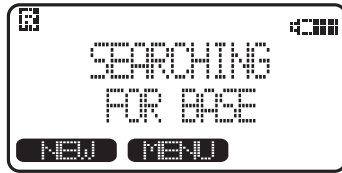

then

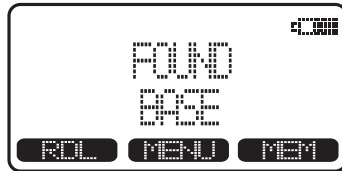

# Warranty Statement

---

## WHAT DOES OUR WARRANTY COVER?

- Any defect in material or workmanship.

## FOR HOW LONG AFTER THE ORIGINAL PURCHASE?

- To the original purchaser only - ONE YEAR.

## WHAT WILL VTECH DO?

- At our option, repair or replace your unit.

## HOW DO I SEND MY UNIT, IN OR OUT OF WARRANTY?

- In the U.S. Call VTech Communications Inc customer service for Return Authorization at: 1-800-595-9511. In Canada, call VTech Electronics Ltd at 1-800-267-7377
- Properly pack your unit. Include any cables & accessories which were originally provided with the product. We recommend using the original carton and packing materials.
- Include in the package a copy of the sales receipt or other evidence of date of original purchase (if the unit was purchased within the last twelve months).
- Print your name and address, along with a description of the defect, and include this in the package.
- Include payment for any service or repair not covered by warranty, as determined by VTech Communications Ltd.
- Ship the unit via UPS Insured, or equivalent to:  
In the U.S.

**VTECH COMMUNICATIONS INC.**  
11035 SW 11th STREET  
BDLG. B, SUITE 270  
BEAVERTON, OREGON 97005

If you purchased your phone in Canada, Ship the unit via UPS insured, or equivalent to:

**VTECH ELECTRONICS LTD.**  
SUITE 200-7671 ALDERBRIDGE WAY  
RICHMOND, B.C. V6X 1Z9

*VTech Communications Inc assumes no responsibility for units sent without prior Return Authorization.*

## Warranty Statement

---

### WHAT DOES OUR WARRANTY NOT COVER?

- Batteries
- Damage from misuse, neglect, or acts of nature (lightning, floods, power surges, etc.)
- Products which may have been modified or incorporated into other products
- Products purchased and/or operated outside the USA, its territories, or Canada.
- Products serviced by the owner or a service facility not expressly authorized by VTECH Communications
- Products purchased more than 12 months from current date
- Units purchased in "AS IS" condition, or units purchased as "Distressed Merchandise".

### HOW DOES STATE LAW OR PROVINCIAL LAW RELATE TO THIS WARRANTY?

- This warranty gives you specific rights. You may also have other rights which vary from state to state or province to province.

This equipment complies with Parts 15 of the Federal Communications Commission (FCC) rules for the United States. It also complies with regulations RSS210 and CS-03 of Industry and Science Canada. Operation is subject to the following two conditions: (1) this device may not cause interference, and (2) this device must accept any interference, including interference that may cause undesired operation of the device.

A label is located on the underside of the Base Unit containing either the FCC registration number and Ringer Equivalence Number (REN) or the IC registration number and Load Number. You must, upon request, provide this information to your local telephone company.

This equipment is compatible with inductively coupled hearing aids.

Should you experience trouble with this telephone equipment, please contact:

### **VTech Communications Inc**

SERVICE DEPT. at 1-800-595-9511. In Canada, call VTECH Electronics at 1-800-267-7377.

For repair/warranty information. The telephone company may ask you to disconnect this equipment from the line network until the problem has been corrected.

### **FCC Part 15**

**Warning:** Changes or modifications to this unit not expressly approved by the party responsible for compliance could void the user's authority to operate the equipment.

The equipment has been tested and found to comply with part 15 of the FCC rules. These limits are designed to provide reasonable protection against harmful interference in a residential installation. This equipment generates, uses and can radiate radio frequency energy and, if not installed and used in accordance with the instructions, may cause harmful interference to radio communications. However, there is no guarantee that interference will not occur in a particular installation. If this equipment does cause harmful interference to radio or television reception, which can be determined by turning the equipment off and on, the user is encouraged to try and correct the interference by one or more of the following measures:

- Reorient or relocate the receiving antenna.
- Increase the separation between the equipment and receiver.
- Connect the equipment into an outlet or on a circuit different from that to which the receiver is connected.
- Consult the dealer or an experienced radio/TV technician for help.

## FCC Part 68

The FCC requires that you connect your cordless telephone to the nationwide telephone network through a modular telephone jack (USOC RJ11C, RJ11W or RJ14).

Your telephone company may discontinue your service if your equipment causes harm to the telephone network. They will notify you in advance of disconnection, if possible. During notification, you will be informed of your right to file a complaint with the FCC.

Occasionally, your telephone company may make changes in its facilities, equipment, operation, or procedures that could affect the operation of your equipment. If so, you will be given advance notice of the change to give you an opportunity to maintain uninterrupted service.

The Base Unit contains no user serviceable parts. The Handset contains a user replaceable battery pack.

If it is determined that your telephone equipment is malfunctioning, the FCC requires that it not be used and that it be unplugged from the modular jack until the problem has been corrected. Repairs to this telephone equipment can only be made by the manufacturer or its authorized agents or by others who may be authorized by the FCC. For repair procedures, follow the instructions outlined under the VTECH Limited Warranty.

This equipment may not be used on coin service provided by the phone company or Party Lines.

The REN is useful in determining the number of devices you may connect to your telephone line and still enable the devices to ring when you receive a call. The general rule is that the REN value should not exceed 5.0A total; however, contact your local telephone company for the specific number in your area.

## IC (Industry Canada)

This telephone is registered for use in Canada.

### Notice :

The REN assigned to this device denotes the number of devices you may connect to the telephone loop which is used by the device to prevent overloading. The termination on a loop may consist of any combination of devices subjected only to the requirement that the sum of the REN does not exceed five (5.0)

### Notice :

The Industry Canada label identifies certified equipment. This certification means that the equipment meets certain telecommunications network protective, operational and safety requirements. The Department does not guarantee the equipment will operate to the user's satisfaction.

## FCC and IC Regulations

---

Before installing this equipment, users should ensure that it is permissible to be connected to the facilities of the local telecommunications company. The equipment must also be installed using an acceptable method of connection. The customer should be aware that compliance with the above conditions may not prevent degradation of services in some situations.

Repairs to certified equipment should be made by an authorized Canadian maintenance facility designated by the supplier. Any repairs or alterations made by the user to this equipment, or equipment malfunctions, may give the telecommunications company cause to request the user to disconnect the equipment.

Users should ensure for their own protection that the electrical ground connections of the power utility, telephone lines and internal metallic water pipe system, if present, are connected together. This precaution may be particularly important in rural areas.

### **Caution :**

Users should not attempt to make such connections themselves, but should contact the appropriate electrical inspection authority, or electrician, as appropriate.

Your VT 2461 is designed to operate at the maximum power allowed by the FCC and IC. This means your Handset and Base Unit can communicate only over a certain distance - which will depend on the location of the Base Unit and Handset, weather, and the construction and layout of your home or office.

## Technical Specifications

---

### FREQUENCY CONTROL

Crystal controlled  
PLL synthesizer

### TRANSMIT FREQUENCY

2401.056 - 2481.408 MHz

### RECEIVE FREQUENCY

2401.056 - 2481.408 MHz

### CHANNELS

94 Channels

### NOMINAL EFFECTIVE RANGE

Maximum power allowed by FCC and IC. Actual operating range may vary according to environmental conditions at the time of use.

### SIZE

Handset : 48mm x 33mm x 175mm

Base : 170mm x 115mm x 60mm

### WEIGHT

Handset : 185 grams

Base : 375 grams

### POWER REQUIREMENTS

Handset : 2.4 VDC NiMH Battery  
Pack

Base : 7 VDC @ 900mA

### MEMORY

Speed Dial: 50 Memory locations, into  
32 digits per location.

CID : Alpha Numeric Display  
50 Memory locations

**SPECIFICATIONS ARE  
TYPICAL AND MAY CHANGE  
WITHOUT NOTICE.**

# Table Of Contents

---

|     |   |            |   |
|-----|---|------------|---|
| 1.  | Important Safety Instructions               | 28.        | Low Battery Indication                      |
|     |   | 28.        | Message Waiting Indication                  |
| 3.  | Introduction                                | 29.        | Conference Calling                          |
| 4.  | Parts Check List                            | 29.        | Transferring Calls                          |
| 5.  | The Handset Layout                          |            |   |
| 6.  | The Base Unit Layout                        |            |   |
|     |   | <b>30.</b> | <b>Itad Operation</b>                       |
| 7.  | Getting Started                             | 30.        | Answering System Setup                      |
| 7.  | Setup                                       | 30.        | Answering System                            |
| 9.  | Installation of Battery Pack in Handset     | 30.        | Programming Overview                        |
| 10. | Spare Battery Charger/Power Backup Function | 30.        | Set Outgoing Message (OGM)                  |
| 11. | Charging Of Handset Battery Pack            | 31.        | Set Security Code                           |
| 12. | Wall Mounting                               | 32.        | Day and Time                                |
| 13. | Registration and Operation                  | 32.        | Set Audible Message Alert                   |
|     |   | 33.        | Set Announce Only                           |
|     |   | 33.        | Set Number of Rings                         |
|     |   | 33.        | Set Base Ringer On/Off                      |
|     |   | 34.        | Leaving a Message (Incoming Message)        |
| 15. | Basic Operation                             | 34.        | Listening to Messages / Memos               |
| 15. | Handset and Base Indicators                 | 35.        | Saving Messages                             |
| 17. | Soft Menu Functions                         | 35.        | Turning the Answering Machine ON/OFF        |
| 17. | RDL (Redial)                                | 36.        | Check Current Day and Time                  |
| 17. | MENU  | 36.        | Changing Speaker Volume                     |
| 18. | Calls Log (Caller ID)                       | 36.        | Changing Playback Speed                     |
| 19. | Handset Settings                            | 37.        | Auto Disconnect for Extension Phone Pick-up |
| 20. | Register                                    | 37.        | Memory Full                                 |
| 21. | MEM (Memory)                                | 37.        | Power Failure                               |
| 22. | Soft Mem Functions                          | 38.        | BASE UNIT MESSAGE WINDOW (LED)              |
| 22. | To Store a Number/Name                      | 39.        | Remote Operation Of Answering System        |
| 23. | To Search For and Dial a Number/Name        |            |   |
| 23. | To Delete a Number/Name                     |            |   |
| 24. | To Edit a Number/Name                       |            |   |
|     |   | <b>42.</b> | <b>Additional Information</b>               |
| 25. | Advanced Operations                         | 42.        | Headset Operation                           |
| 25. | Handset and Base Operation                  | 43.        | Maintenance                                 |
| 25. | Making Calls                                | 44.        | In Case Of Difficulty                       |
| 25. | Answering Calls                             | 46.        | Warranty Statement                          |
| 25. | Mute Function                               | 48.        | FCC and IC Regulations                      |
| 25. | Hold Function                               | 51.        | Technical Specifications                    |
| 26. | Flash Function                              |            |   |
| 26. | Volume Control                              |            |   |
| 27. | Page/Intercom                               |            |   |
| 28. | Handsfree Speakerphone Operation            |            |   |
| 28. | Line in Use Indication                      |            |   |