

vtech®

Bluetooth®

Abridged user's manual DS6511/DS6511-15/DS6511-16/ DS6511-2/DS6511-3



DECT 6.0 cordless telephone with BLUETOOTH® wireless technology



Telephones identified with this logo have reduced noise and interference when used with most T-coil equipped hearing aids and cochlear implants. The TIA-1083 Compliant Logo is a trademark of the Telecommunications Industry Association. Used under license.



The ENERGY STAR® program (www.energystar.gov) recognizes and encourages the use of products that save energy and help protect our environment. We are proud to mark this product with the ENERGY STAR® label indicating it meets the latest energy efficiency guidelines.

Introduction

To protect our environment and conserve natural resources, this Abridged user's manual provides you with the basic installation and use instructions. A limited set of features are described in abbreviated form.

Please refer to the online Complete user's manual for a full set of installation and operation instructions at www.vtechphones.com.

Before using this VTech product, please read **Important safety instructions** on page 11 of this user's manual.

Table of contents

Parts checklist.....	1	Add and register a handset.....	9
Telephone base and charger installation.....	2	Replace a handset.....	9
Battery installation.....	2	Troubleshooting.....	9
Battery charging.....	2	Important safety instructions.....	11
Tabletop to wall mount installation.....	3	Precautions for users of implanted cardiac pacemakers.....	11
Handset overview.....	3	Operating range.....	11
Telephone base overview.....	4	ECO mode.....	11
Bluetooth.....	4	Maintenance.....	12
Using the handset menu.....	4	About cordless telephones.....	12
Telephone settings.....	5	The RBRC® seal.....	12
Telephone operation.....	6	Limited warranty.....	12
Directory.....	7	FCC, ACTA and IC regulations.....	13
Speed dial.....	8	Technical specifications.....	14
Caller ID.....	8		

Parts checklist

Your telephone package contains the following items. Save your sales receipt and original packaging in the event warranty service is necessary.



Battery compartment cover
(1 for DS6511/DS6511-15/
DS6511-16)
(2 for DS6511-2)
(3 for DS6511-3)



Battery
(1 for DS6511/
DS6511-15/
DS6511-16)
(2 for DS6511-2)
(3 for DS6511-3)



Handset
(1 for DS6511/
DS6511-15/
DS6511-16)
(2 for DS6511-2)
(3 for DS6511-3)



Wall mount bracket



Telephone line cord

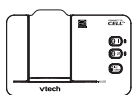

Telephone base



Telephone base power adapter

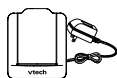

Charger and charger adapter
(1 for DS6511-2)
(2 for DS6511-3)



Abridged user's manual

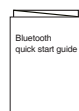

Bluetooth quick start guide

Telephone base and charger installation

Install the telephone base and charger as shown below.

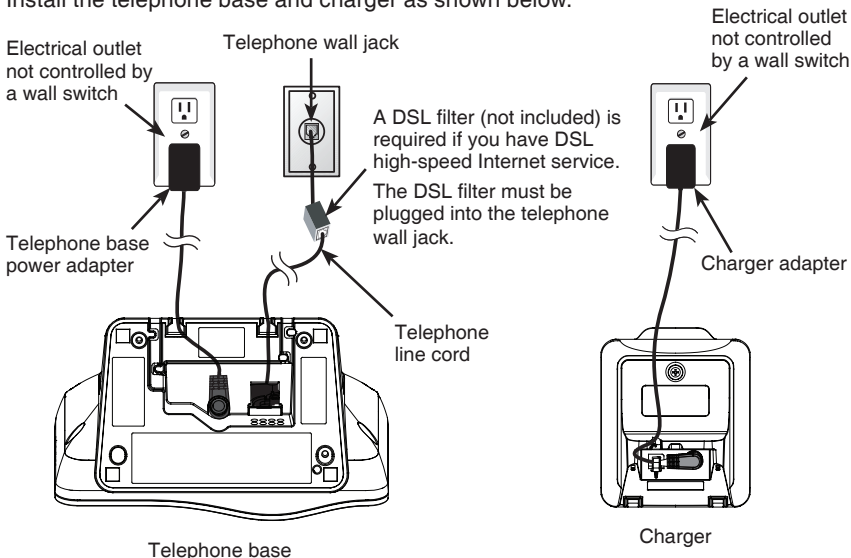

note Use only the power adapters and batteries supplied with this product. To order a replacement, visit our website at www.vtechphones.com or call 1 (800) 595-9511. In Canada, go to www.vtechcanada.com or call 1 (800) 267-7377.

Battery installation

Install the battery as shown below.

1. Plug the battery connector securely into the socket.
2. Place the battery with the label **THIS SIDE UP** facing up and the wires inside the battery compartment.

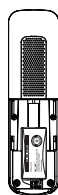
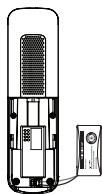

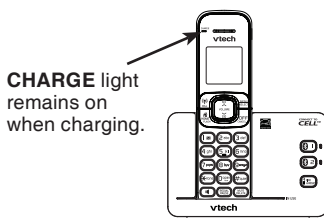

3. Slide the battery compartment cover towards the center of the handset until it clicks into place.
4. Place the handset in the telephone base or charger to charge.



note If the handset will not be used for a long time, disconnect and remove the battery to prevent possible leakage.

Battery charging

Once you have installed the battery, the screen indicates the battery status (see the table below). For best performance, keep the handset in the telephone base or charger when not in use. The battery is fully charged after 12 hours of continuous charging.

Battery indicators	Battery status	Action
The screen is blank, or shows Put in charger and  flashes.	The battery has no charge or very little charge. The handset cannot be used.	Charge without interruption (at least 30 minutes).
The screen shows Low battery and  flashes.	The battery has enough charge to be used for a short time.	Charge without interruption (at least 30 minutes).
The screen shows HANDSET X .	The battery is charged.	To keep the battery charged, place it in the telephone base or charger when not in use.

note If you place the handset in the telephone base or charger without plugging in the battery, the screen displays **NO BATTERY**.

Tabletop to wall mount installation

The telephone comes ready for tabletop use. Follow the steps below to mount your telephone on a wall.

1. If you have already installed the telephone for tabletop use, unplug the telephone line cord from the telephone wall jack, and unplug the telephone base power adapter from the wall outlet. Remove the telephone line cord and the power adapter cord from the grooves.
2. Route the telephone line cord through the rectangular hole on the wall mount bracket and plug it into the telephone wall jack. Route the power cord out of the telephone base and plug it into an electrical outlet not controlled by a wall switch.

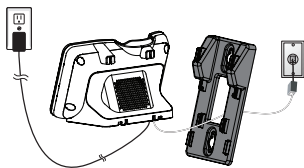
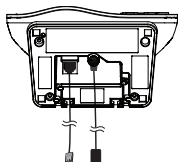

3. Position the lower portion grooves on the telephone base to the lower portion tabs (marked **B**) on the wall mount bracket. Make sure the upper portion grooves of the telephone base are above the upper portion tabs (marked **A**) on the wall mount bracket. Push the telephone base down until it clicks securely in place.
4. Align the holes on the bracket with the standard wall plate and slide the bracket down until it locks securely. Bundle the telephone line cord and power adapter cord neatly with twist ties.

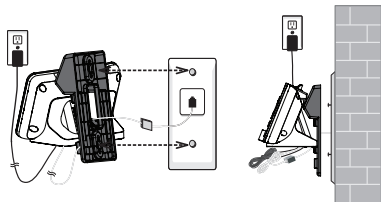
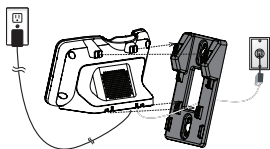

Handset overview

CHARGE light

On when the handset is charging.

VOLUME/

Review the directory when the phone is not in use.

Increase the listening volume during a call.

Scroll up while in a menu, or in the directory, caller ID log or redial list.

Move the cursor to the right when entering numbers or names.

/CELL

Make or answer a cell call.

Answer an incoming cell call when you hear a call waiting alert.

/HOME/FLASH

Make or answer a home call.

Answer an incoming home call when you hear a call waiting alert.

1

Press repeatedly to add or remove 1 in front of the caller ID log entry before dialing or saving it to the directory.

Press and hold to set or dial your voicemail number.

*tone

Switch to tone dialing temporarily during a call.

Speakerphone icon

Make or answer a call using the handset speakerphone.

During a call, press to switch between the speakerphone and the handset.

REDIAL/PAUSE

Press repeatedly to review the redial list.

Press and hold to insert a dialing pause while entering a number.

VOLUME/~/CID

Review the caller ID log when the phone is not in use.

Decrease the listening volume during a call.

Scroll down while in a menu, or in the directory, caller ID log or redial list.

Move the cursor to the left when entering numbers or names.

MENU/SELECT

Show the menu.

While in a menu, press to select an item, or save an entry or setting.

OFF/CANCEL

Hang up a call.

Silence the ringer temporarily while the handset is ringing.

Press and hold to erase the missed call indicator while the phone is not in use.

Press to return to the previous menu, or press and hold to return to idle mode, without making changes.

Dialing keys

Enter numbers or characters.

#quiet

Press repeatedly to show other dialing options when reviewing a caller ID log entry.

Press and hold to set and turn off the quiet mode, or turn it off.

MUTE/DELETE

Mute the microphone during a call.

Delete digits or characters while using the dialing keys.

Silence the ringer temporarily while the handset is ringing.

Delete the displayed entry while in the directory, caller ID log or redial list.

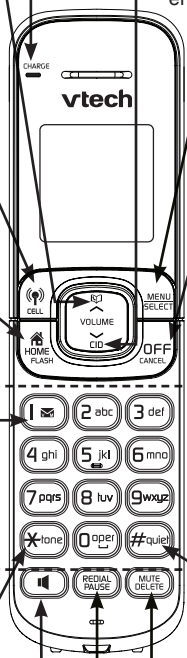

Telephone base overview

1 and 2

Press to connect the paired cell phone.

Press and hold to add or replace a cell phone.

IN USE light

Flashes when there is an incoming call, or another telephone sharing the same line is in use.

On when the handset is in use.

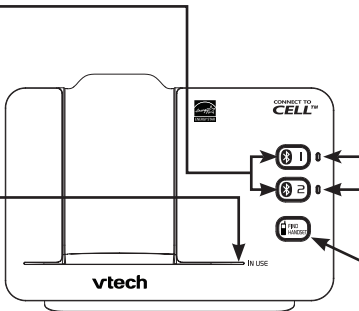

1 and 2 lights

On when the telephone base is paired and connected with a Bluetooth device.

Alternates when the telephone base is in discoverable mode.

FIND HANDSET

Press to page all system handsets.

Bluetooth

To use a Bluetooth enabled cell phone with your **DS6511**, you must first pair and connect your Bluetooth cell phone(s) with the telephone base. All **DS6511** handsets can be used to make or answer calls on the cell line.

Bluetooth wireless technology operates within a short range (a maximum of approximately 30 feet). When you pair a Bluetooth cell phone to the telephone base, make sure your Bluetooth cell phone is close to the telephone base to maintain sufficient signal strength.

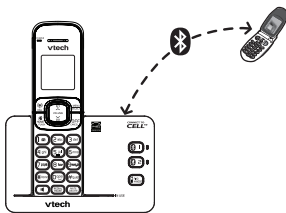

Pair and connect your first Bluetooth cell phone

1. Press and hold 1/ 2 on the telephone base for about four seconds. The 1/ 2 light blinks.
2. Turn on the Bluetooth feature of your cell phone. Once your cell phone finds your VTech phone (**VTech DS6511**), press the appropriate key on your cell phone to continue the pairing process.
 - Your cell phone may prompt you to enter the PIN of the telephone base. The default PIN of the telephone base is **0000**.

Download directory

1. Press **MENU** when the phone is not in use.
2. Scroll to **Bluetooth** then press **SELECT**.
3. Scroll to **Download dir** then press **SELECT**.
4. Scroll to select the desired cell phone, then press **SELECT**.

Using the handset menu

1. Press **MENU** when the phone is not in use.
2. Press or until the screen displays the desired feature menu.
3. Press **SELECT** to enter that menu.
 - To return to the previous menu, press **CANCEL**.
 - To return to idle mode, press and hold **CANCEL**.

Telephone settings

Default settings are indicated by asterisks(*).

Settings menu	Description	Options
LCD language	Set the screen display language.	English* Français Español
Voicemail #	Set the voicemail number for speed dial.	Voicemail # —
Clr voicemail	Turn off the voicemail indicators (see the note below).	Reset VM Icon?
Key tone	Turn an audible beep on or off whenever a key is pressed.	Key tone:On* Key tone:Off
Home area code	Enter your home area code if you dial only seven digits for local calls.	Home area code — — —
Dial mode	Set the telephone to be touch-tone or pulse dialing.	Touch-tone* Pulse

note

Use the **Clr voicemail** feature when the telephone indicates there is new voicemail but there is none. For example, when you have accessed your voicemail while away from home. The **Clr voicemail** feature only turns off the indicators; it does not delete your voicemail messages. As long as you have new voicemail messages, your telephone service provider continues to send the signal that turns on the indicators.

The following are some of the telephone features you may wish to set. Refer to **Telephone settings** in the online Complete user's manual for detailed instructions on setting all telephone features.

Ringer volume

You can adjust the ringer volume level, or turn the ringer off.

1. Press **MENU** when the handset is not in use.
2. Scroll to **◆Ringers** then press **SELECT**.
3. Scroll to choose **◆Home volume** or **◆Cell volume**, then press **SELECT**.
4. Press **∨** or **∧** to adjust the volume, then press **SELECT** to save.

note

If the handset ringer volume is set to off, that handset is silenced for all incoming calls except paging tone.

Quiet mode

You can turn on the quiet mode for a period of time. During this period, all tones (except paging tone) and call screening are muted.

1. Press and hold #quiet when the handset is not in use.
 2. Use the dialing keys (**0-9**) to enter the duration, then press **SELECT** to save.
- To turn off the quiet mode, press and hold #quiet when the handset is not in use.

Set date and time

If you subscribe to caller ID service, the day, month and time are set automatically with each incoming call. You can also set the date and time manually.

1. Press **MENU** when the handset is not in use.
2. Scroll to **◆Set date/time**, then press **SELECT**.
3. Use the dialing keys (**0-9**) to enter the month, date and year, then press **SELECT**.
4. Use the dialing keys (**0-9**) to enter the hour and minute.
5. Press **∨** or **∧** to choose **AM** or **PM**, then press **SELECT** to save.

Voicemail indicators

If you subscribe to voicemail service offered by your telephone service provider, **New voicemail** and  appear on the handsets when you have new voicemail messages. Contact your telephone service provider for more information and assistance about using your voicemail service. Refer to **Clear voicemail indicators** in the online Complete user's manual on how to clear the voicemail indicators.

Telephone operation

Make a home call

- Press **HOME** or **CALL**, and then dial the telephone number.

-OR-

- Enter the telephone number and then press **HOME** or **CALL**.

Make a cell call

- Press **CELL**. Scroll to select the desired cell phone when necessary, then press **SELECT**.

- Enter the telephone number and then press **CELL** to dial.

-OR-

- Enter the telephone number, then press **CELL**.
- Scroll to select the desired cell phone when necessary, then press **SELECT**.

Answer a home/cell call

- For a home line call, press **HOME**, **CALL** or any dialing key.
- For a cell line call, press **CELL**, **CALL** or any dialing key.

End a home/cell call

- Press **OFF** or put the handset to the telephone base or charger.

Speakerphone

- During a call, press **CALL** to switch between speakerphone and normal handset use.

Volume

- During a call, press **VOLUME** or **VOLUME** to adjust the listening volume.

note

The handset earpiece volume setting and speakerphone volume setting are independent.

Mute

The mute function allows you to hear the other party but the other party cannot hear you.

- During a call, press **MUTE**. The handset displays **Muted**.
- Press **MUTE** again to resume the conversation.

Call waiting

When you subscribe to call waiting service from your telephone service provider, you hear an alert tone if there is an incoming call while you are on another call.

- For a home call, press **FLASH** to put the current call on hold and take the new call, or switch back and forth between calls.
- For a cell call, press **CELL** to put the current call on hold and take the new call, or switch back and forth between calls.

Temporary ringer silencing

When the telephone is ringing, you can temporarily silence the ringer of the handset without disconnecting the call. The next call rings normally at the preset volume.

- Press **OFF** or **MUTE** on the handset. **Ringer muted** displays briefly.

Temporary tone dialing

If you have pulse (rotary) service only, you can switch from pulse to tone dialing temporarily during a call.

- During a call, press ***tone**.
- Use the dialing keys to enter the relevant number. The telephone sends touch-tone signals.
- The telephone automatically returns to pulse dialing mode after you end the call.

Find handset

Use this feature to find all system handsets.

To start paging:

- Press **FIND HANDSET** on the telephone base. All idle handsets ring and display **** Paging ****.

To end paging:

- Press **FIND HANDSET** again on the telephone base.
- Press **HOME**, **CELL**, **CALL**, **CANCEL** or any dialing key on the handset.
- Place the handset in the telephone base or charger.

note

Do not press and hold **FIND HANDSET** for more than four seconds. It may lead to handset deregistration.

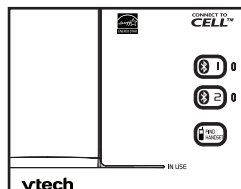
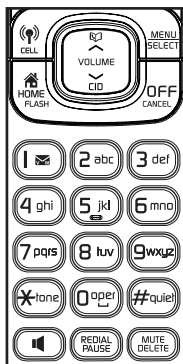

Redial list

Each handset stores the last 10 telephone numbers dialed.

To review and dial a number from the redial list:

1. Press **REDIAL** when the handset is not in use.
2. Press \downarrow , \uparrow or **REDIAL** repeatedly until the desired entry displays.
3. Press HOME or CELL to dial.

To delete a redial entry:

When the desired redial entry displays, press **DELETE**.

Chain dialing

Use this feature to initiate a dialing sequence from numbers stored in the directory, caller ID log or redial list while you are on a call. Chain dialing can be useful if you wish to access other numbers (such as bank account numbers or access codes) from the directory, caller ID log or redial list.

To access a number in the directory, caller ID log or redial list while on a call:

1. To enter the directory, press **MENU/SELECT** twice.

-OR-

To enter the caller ID log, press **MENU**, then scroll to \blacklozenge **Caller ID log**, and then press **SELECT**.

-OR-

To enter the redial list, press **REDIAL**.

2. Press \downarrow or \uparrow to scroll to the desired entry.
3. Press **SELECT** to dial the displayed number.

Join a call in progress

You can use up to two system handsets at a time on a home line call. You can buy additional expansion handsets (**DS6501/DS6501-12/DS6501-15/DS6501-16**) for this telephone base. You can register up to five handsets to the telephone base.

- When a handset is on a call, press HOME or M on another handset to join the call.
- Press **OFF** to exit the call. The call continues until all handsets hang up.

Transfer a call

While on an outside call, you can transfer the call from one handset to another.

1. During a call, press **MENU**.
2. Press \downarrow or \uparrow to scroll to \blacklozenge **Transfer**, then press **SELECT**. Use the dialing keys to enter a destination handset number.
3. To answer the call on the destination handset, press HOME , CELL or M .

Intercom

Use the intercom features for conversations between two handsets.

1. Press **MENU** on your handset when not in use.
2. Press \downarrow or \uparrow to scroll to \blacklozenge **Intercom**, then press **SELECT**. Use the dialing keys to enter a destination handset number.
3. To answer the intercom call, press HOME , CELL or M on the destination handset.
4. To end the intercom call, press **OFF** or place the handset back in the telephone base or charger.

Answer an incoming call during an intercom call

If you receive an incoming call during an intercom call, there is an alert tone.

- To answer a home call, press HOME . The intercom call ends automatically.
- To end the intercom call without answering the outside call, press **OFF**. The intercom call ends and the telephone continues to ring.
- To answer a cell call, press **OFF** to end the intercom call. The telephone continues to ring. Then press CELL .

Directory

The directory can store up to 200 entries and are shared by all system handsets.

To add a directory entry:

1. Press **MENU** when the phone is not in use.
 2. Scroll to \blacklozenge **Directory** then press **SELECT** twice.
 3. Enter the number.
 - Use the dialing keys to enter the number (up to 30 digits).
- OR-**
- Copy a number from the redial list by pressing **REDIAL**. Then press \downarrow , \uparrow or **REDIAL** repeatedly to select a number. Press **SELECT**.
 4. Press **SELECT** to move to the name.
 5. Use the dialing keys to enter the name (up to 15 characters). Additional key presses show other characters of that particular key.
 6. Press **SELECT** to save.

While entering numbers and names, you can:

- Press **DELETE** to erase a digit or character.
- Press and hold **DELETE** to erase the entire entry.
- Press \blacktriangleleft or \blacktriangleright to move the cursor to the left or right.
- Press and hold **PAUSE** to insert a dialing pause (for entering phone numbers only).
- Press **0** to add a space (for entering names only).

To review and dial from the directory:

Entries are sorted alphabetically.

1. Press \mathcal{M} when the phone is not in use.
2. Scroll to browse through the directory, or use the dialing keys to start a name search.
3. When the desired entry appears, press \mathcal{H} /**HOME** or \mathcal{C} /**CELL** to dial.

To edit a directory entry:

1. When the desired entry displays, press **SELECT**.
2. Use the dialing keys to edit the number, then press **SELECT**.
3. Use the dialing keys to edit the name, then press **SELECT** to save.

To delete a directory entry:

1. When the desired entry displays, press **DELETE**.
2. When the screen displays **Delete contact?**, press **SELECT**.

To delete all directory entries:

1. Press **MENU** when the phone is not in use.
2. Scroll to \blacklozenge **Directory** then press **SELECT**.
3. Scroll to \blacklozenge **Del all conts** then press **SELECT**.
4. When the screen displays **Delete all?**, press **SELECT**.

Speed dial

You can copy up to 9 directory entries into the speed dial locations (**0** and **2-9**) so that you can dial these numbers via the home line using fewer keys than usual.

To assign a speed dial entry:

1. Press **MENU** when the phone is not in use.
2. Scroll to \blacklozenge **Directory** then press **SELECT**.
3. Scroll to \blacklozenge **Speed dial**, then press **SELECT**.
4. Scroll to a desired speed dial location, then press **SELECT**.
5. Scroll to a desired directory entry, then press **SELECT** to save.

To dial a speed dial entry:

- Press and hold a dialing key (**0** or **2-9**) to dial the number stored in the corresponding location.

To delete a speed dial entry:

When the desired entry displays, press **DELETE**, then press **SELECT**.

Caller ID

This product supports caller ID services provided by most telephone service providers. Depending on your service subscription, you may see the caller's name, number, date and time of calls that are sent by your telephone service provider after the first or second ring.

Caller ID log

The caller ID log stores up to 50 entries. If you answer a call before the caller information appears, it will not be saved in the caller ID log.

- The handset displays **XX missed calls** when there are calls that have not been reviewed in the caller ID log.
- If you want to erase the missed call indicator, press and hold **CANCEL** on the idle handset.

To review and dial a number in the caller ID log:

1. Press **CID** when the phone is not in use.
2. Scroll to browse through the caller ID log. When the desired entry appears:
 - Press $\#$ _{quiet} repeatedly to show different dialing options.
 - Press **1** repeatedly if you need to add or remove 1 in front of the phone number.
3. Press \mathcal{H} /**HOME**, \mathcal{M} or \mathcal{C} /**CELL** to dial the displayed number.

To save a caller ID log entry to the directory:

1. When the desired caller ID log entry displays, press **SELECT**.
2. Use the dialing keys to modify the number, then press **SELECT**.
3. Use the dialing keys to modify the name, then press **SELECT** to save.

To delete a caller ID log entry:

- When the desired caller ID log entry displays, press **DELETE**.

To delete all caller ID log entries:

- Press **MENU** when the phone is not in use. Scroll to \blacklozenge **Caller ID log** and then press **SELECT**. Scroll to \blacklozenge **Del all calls** and then press **SELECT** twice.

Add and register a handset

The handsets provided with your telephone system are already registered. Each handset is assigned a number that displays on the handset. Additional handsets registered to the telephone system are assigned numbers in the sequential order. This telephone system accommodates up to five handsets.

You can add new handsets (**DS6501/DS6501-12/DS6501-15/DS6501-16**, purchased separately) to your telephone system. Each handset must be registered with the telephone base before use. When first purchased and properly charged, each expansion handset shows **To register HS...** and **...see manual** alternately. Charge the handset before registering it to the telephone base.

To register a handset:

1. Place the new/non-registered handset in the telephone base.

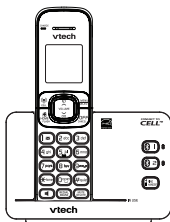

Do not place the handset in the charger.

2. Wait for about 10 seconds. The handset shows **Registering...** then **Registered** and you hear a beep when the registration process completes. The registration process takes about 90 seconds to complete.

Replace a handset

If you want to replace a handset or reassign the designated handset number of a registered handset, you must deregister all handsets and then individually register each handset.

To deregister all handsets:

1. Press and hold **FIND HANDSET** on the telephone base for about 10 seconds until the **IN USE** light on the telephone base turns on and starts flashing.
2. Immediately press **FIND HANDSET** again. You must press **FIND HANDSET** while the **IN USE** light is still flashing. The **IN USE** light flashes for approximately five seconds.
3. All handsets show **To register HS...** and **...see manual** alternately when the deregistration process completes. The deregistration process takes about 10 seconds to complete.

Troubleshooting

If you have difficulty with your telephone, please try the suggestions below. For customer service, visit our website at www.vtechphones.com or call 1 (800) 595-9511. In Canada, go to www.vtechcanada.com or call 1 (800) 267-7377.

I cannot add and connect my cell phone to the telephone base.

- Make sure you have cellular coverage.
- Make sure your cell phone is compatible with your **DS6511**. Check the Bluetooth compatibility list at www.vtechphones.com.
- Make sure the Bluetooth function of your cell phone is turned on. See the user's manual of your cell phone for more information.
- Make sure that your Bluetooth cell phone is not connected to any other Bluetooth device.
- To connect your cell phone, make sure that your cell phone is connected and active on the device list.
- Remove **VTech DS6511** from your cell phone's handsfree device history list (see the user's manual of your cell phone for more information).
- Carefully follow the pairing instructions on page 4 and make sure that your cell phone is not connected to any other Bluetooth device.
- Turn off your cell phone, then turn it on again.
- For some cell phones, you must authorize **VTech DS6511** device in your cell phone's Bluetooth feature. See the user's manual of your cell phone for more information.
- Manually connect your cell phone to **VTech DS6511**. Refer to the user's manual of your cell phone for more information.
- Reset the telephone base. Unplug the unit's electrical power. Wait for approximately 15 seconds, then plug it back in. Repeat the above suggestions.

I cannot find VTech DS6511 on my cell phone.

- Make sure that the telephone base is in discoverable mode.
- Make sure that you manually set your cell phone to search for devices.
- Remove **VTech DS6511** from your cell phone's handsfree device history list (see the user's manual of your cell phone).
- Turn off your cell phone, then turn it on again.
- Reset the telephone base. Unplug the unit's electrical power. Wait for approximately 15 seconds, then plug it back in. Repeat the above suggestions.

I don't know how to search for or add new devices on my cell phone.

- Most cell phones have the Bluetooth feature in the connection or setup menus. Please refer to the user's manual of your cell phone.
- In general, press the menu key on your cell phone, then look for the Bluetooth menu in the settings or connection menu. In the Bluetooth menu, select the option to search for or add new devices.

The PIN on the telephone base does not work.

- Make sure you enter the correct PIN. The default PIN is **0000**.

Can the DS6511 help the poor cell phone reception in my house?

- If your cell phone has poor reception in your home, the **DS6511** cannot improve the reception. However, if there is a location in your house with better reception, you can leave your cell phone at that location while you use the **DS6511** cell line. In order for this to work, the telephone base must be within 30 feet of the cell phone.

My telephone does not work at all.

- Make sure the battery is installed and charged correctly. For optimum daily performance, return the handset to the telephone base or charger after use.
- Make sure the power adapter is securely plugged into an outlet not controlled by a wall switch.
- Make sure the telephone line cord is plugged firmly into the telephone base and the wall jack.
- Unplug the electrical power to the telephone base. Wait for approximately 15 seconds, then plug it back in. Allow up to one minute for the cordless handset and telephone base to synchronize.
- Charge the battery in the handset for up to 12 hours.
- If the battery is completely depleted, charge the handset for at least 30 minutes before use.
- Remove the battery and then install it again. If that still does not work, it may be necessary to purchase a new battery.
- Disconnect the telephone base from the telephone wall jack and plug in a working telephone. If the other telephone does not work, the problem is probably in the wiring or telephone service. Contact your telephone service provider.

I cannot dial out.

- Try all the above suggestions.
- Make sure there is a dial tone before dialing. It is normal if the handset takes a second or two to synchronize with the telephone base before producing a dial tone. Wait an extra second before dialing.
- If other telephones in your home are having the same problem, the problem is in the wiring or telephone service. Contact your telephone service provider (charges may apply).
- Eliminate any background noise. Mute the cordless handset before dialing, or dial from another room in your home with less background noise.

I accidentally changed the LCD language to French or Spanish, and I don't know how to change it back to English.

- While the phone is not in use, press **MENU**, then enter ***tone 364 #quiet** to reset the LCD language to English.
- While the phone is on a call, press **MENU**, then enter ***tone 364 #quiet** to reset the LCD language to English. Then the call ends.

Common cure for electronic equipment.

- If the telephone is not responding normally, put the cordless handset in the telephone base. If this does not fix the problem, do the following (in the order listed):
 1. Disconnect the power to the telephone base.
 2. Disconnect the battery on the cordless handset.
 3. Wait a few minutes before connecting power to the telephone base.
 4. Install the battery again and place the cordless handset in the telephone base .
 5. Wait for the cordless handset to synchronize with the telephone base. Allow up one minute for this to take place.

Important safety instructions

When using your telephone equipment, basic safety precautions should always be followed to reduce the risk of fire, electric shock and injury, including the following:

1. Read and understand all instructions.
2. Follow all warnings and instructions marked on the product.
3. Unplug this product from the wall outlet before cleaning. Do not use liquid or aerosol cleaners. Use a damp cloth for cleaning.
4. Do not use this product near water such as near a bath tub, wash bowl, kitchen sink, laundry tub or swimming pool, or in a wet basement or shower.
5. Do not place this product on an unstable table, shelf, stand or other unstable surfaces.
6. Slots and openings in the back or bottom of the telephone base and handset are provided for ventilation. To protect them from overheating, these openings must not be blocked by placing the product on a soft surface such as a bed, sofa or rug. This product should never be placed near or over a radiator or heat register. This product should not be placed in any area where proper ventilation is not provided.
7. This product should be operated only from the type of power source indicated on the marking label. If you are not sure of the type of power supply in your home or office, consult your dealer or local power company.
8. Do not allow anything to rest on the power cord. Do not install this product where the cord may be walked on.
9. Never push objects of any kind into this product through the slots in the telephone base or handset because they may touch dangerous voltage points or create a short circuit. Never spill liquid of any kind on the product.
10. To reduce the risk of electric shock, do not disassemble this product, but take it to an authorized service facility. Opening or removing parts of the telephone base or handset other than specified access doors may expose you to dangerous voltages or other risks. Incorrect reassembling can cause electric shock when the product is subsequently used.
11. Do not overload wall outlets and extension cords.
12. Unplug this product from the wall outlet and refer servicing to an authorized service facility under the following conditions:
 - When the power supply cord or plug is damaged or frayed.
 - If liquid has been spilled onto the product.
 - If the product has been exposed to rain or water.
 - If the product does not operate normally by following the operating instructions. Adjust only those controls that are covered by the operation instructions. Improper adjustment of other controls may result in damage and often requires extensive work by an authorized technician to restore the product to normal operation.
 - If the product has been dropped and the telephone base and/or handset has been damaged.
 - If the product exhibits a distinct change in performance.
13. Avoid using a telephone (other than cordless) during an electrical storm. There is a remote risk of electric shock from lightning.
14. Do not use the telephone to report a gas leak in the vicinity of the leak. Under certain circumstances, a spark may be created when the adapter is plugged into the power outlet, or when the handset is replaced in its cradle. This is a common event associated with the closing of any electrical circuit. The user should not plug the phone into a power outlet, and should not put a charged handset into the cradle, if the phone is located in an environment containing concentrations of flammable or flame-supporting gases, unless there is adequate ventilation. A spark in such an environment could create a fire or explosion. Such environments might include: medical use of oxygen without adequate ventilation; industrial gases (cleaning solvents; gasoline vapors; etc.); a leak of natural gas; etc.
15. Only put the handset of your telephone next to your ear when it is in normal talk mode.
16. The power adapters are intended to be correctly oriented in a vertical or floor mount position. The prongs are not designed to hold the plug in place if it is plugged into a ceiling, under-the-table or cabinet outlet.

SAVE THESE INSTRUCTIONS

Precautions for users of implanted cardiac pacemakers

Cardiac pacemakers (applies only to digital cordless telephones):

Wireless Technology Research, LLC (WTR), an independent research entity, led a multidisciplinary evaluation of the interference between portable wireless telephones and implanted cardiac pacemakers. Supported by the U.S. Food and Drug Administration, WTR recommends to physicians that:

Pacemaker patients



- Should keep wireless telephones at least six inches from the pacemaker.
- Should NOT place wireless telephones directly over the pacemaker, such as in a breast pocket, when it is turned ON.
- Should use the wireless telephone at the ear opposite the pacemaker. WTR's evaluation did not identify any risk to bystanders with pacemakers from other persons using wireless telephones.

WTR's evaluation did not identify any risk to bystanders with pacemakers from other persons using wireless telephones.

Operating range

This cordless telephone operates with the maximum power allowed by the Federal Communications Commission (FCC). Even so, this handset and telephone base can communicate over only a certain distance - which can vary with the locations of the telephone base and handset, the weather, and the layout of your home or office.

When the handset is out of range, the handset displays **Out of range or no pwr at base**.

If there is a call while the handset is out of range, it may not ring, or if it does ring, the call may not connect well when you press /HOME. Move closer to the telephone base, then press /HOME to answer the call.

If the handset moves out of range during a telephone conversation, there may be interference. To improve reception, move closer to the telephone base.

ECO mode

This power conserving technology reduces power consumption for optimal battery performance, according to the distance between the telephone base and the handset. When the telephone base communicates with the handset, ECO mode will be activated automatically.

Maintenance

Taking care of your telephone

Your cordless telephone contains sophisticated electronic parts, so it must be treated with care.

Avoid rough treatment

Place the handset down gently. Save the original packing materials to protect your telephone if you ever need to ship it.

Avoid water

Your telephone can be damaged if it gets wet. Do not use the handset outdoors in the rain, or handle it with wet hands. Do not install the telephone base near a sink, bathtub or shower.

Electrical storms

Electrical storms can sometimes cause power surges harmful to electronic equipment. For your own safety, take caution when using electrical appliances during storms.

Cleaning your telephone

Your telephone has a durable plastic casing that should retain its luster for many years. Clean it only with a soft cloth slightly dampened with water or mild soap. Do not use excess water or cleaning solvents of any kind.

Remember that electrical appliances can cause serious injury if used when you are wet or standing in water. If the telephone base should fall into water, **DO NOT RETRIEVE IT UNTIL YOU UNPLUG THE POWER CORD AND TELEPHONE LINE CORD FROM THE WALL.** Then remove the telephone by the unplugged cords.

About cordless telephones

- **Privacy:** The same features that make a cordless telephone convenient create some limitations. Telephone calls are transmitted between the telephone base and the cordless handset by radio waves, so there is a possibility that the cordless telephone conversations could be intercepted by radio receiving equipment within range of the cordless handset. For this reason, you should not think of cordless telephone conversations as being as private as those on corded telephones.
- **Electrical power:** The telephone base of this cordless telephone must be connected to a working electrical outlet. The electrical outlet should not be controlled by a wall switch. Calls cannot be made from the cordless handset if the telephone base is unplugged, switched off or if the electrical power is interrupted.
- **Potential TV interference:** Some cordless telephones operate at frequencies that may cause interference to televisions and VCRs. To minimize or prevent such interference, do not place the telephone base of the cordless telephone near or on top of a TV or VCR. If interference is experienced, moving the cordless telephone farther away from the TV or VCR often reduces or eliminates the interference.
- **Rechargeable batteries:** Exercise care in handling batteries in order not to create a short circuit with conducting material such as rings, bracelets, and keys. The battery or conductor may overheat and cause harm. Observe proper polarity between the battery and the battery charger.
- **Nickel-metal hydride rechargeable batteries:** Dispose of these batteries in a safe manner. Do not burn or puncture the battery. Like other batteries of this type, if burned or punctured, they could release caustic material which could cause injury.

The RBRC® seal



The RBRC® seal on the nickel-metal hydride battery indicates that VTech Communications, Inc. is voluntarily participating in an industry program to collect and recycle these batteries at the end of their useful lives, when taken out of service within the United States and Canada.

The RBRC® program provides a convenient alternative to placing used nickel-metal hydride batteries into the trash or municipal waste, which may be illegal in your area.

VTech's participation in RBRC® makes it easy for you to drop off the spent battery at local retailers participating in the RBRC® program or at authorized VTech product service centers. Please call **1 (800) 8 BATTERY™** for information on Ni-MH battery recycling and disposal bans/restrictions in your area.

VTech's involvement in this program is part of its commitment to protecting our environment and conserving natural resources.

RBRC® is a registered trademark of Rechargeable Battery Recycling Corporation.

Limited warranty

What does this limited warranty cover?

The manufacturer of this VTech Product warrants to the holder of a valid proof of purchase ("Consumer" or "you") that the Product and all accessories provided in the sales package ("Product") are free from defects in material and workmanship, pursuant to the following terms and conditions, when installed and used normally and in accordance with the Product operating instructions. This limited warranty extends only to the Consumer for Products purchased and used in the United States of America and Canada.

What will VTech do if the Product is not free from defects in materials and workmanship during the limited warranty period ("Materially Defective Product")?

During the limited warranty period, VTech's authorized service representative will repair or replace at VTech's option, without charge, a Materially Defective Product. If we repair the Product, we may use new or refurbished replacement parts. If we choose to replace the Product, we may replace it with a new or refurbished Product of the same or similar design. We will retain defective parts, modules, or equipment. Repair or replacement of the Product, at VTech's option, is your exclusive remedy. VTech will return the repaired or replacement Products to you in working condition. You should expect the repair or replacement to take approximately 30 days.

How long is the limited warranty period?

The limited warranty period for the Product extends for ONE (1) YEAR from the date of purchase. If VTech repairs or replaces a Materially Defective Product under the terms of this limited warranty, this limited warranty also applies to the repaired or replacement Product for a period of either (a) 90 days from the date the repaired or replacement Product is shipped to you or (b) the time remaining on the original one-year warranty; whichever is longer.

What is not covered by this limited warranty?

This limited warranty does not cover:

1. Product that has been subjected to misuse, accident, shipping or other physical damage, improper installation, abnormal operation or handling, neglect, inundation, fire, water or other liquid intrusion; or
2. Product that has been damaged due to repair, alteration or modification by anyone other than an authorized service representative of VTech; or
3. Product to the extent that the problem experienced is caused by signal conditions, network reliability, or cable or antenna systems; or
4. Product to the extent that the problem is caused by use with non-VTech accessories; or
5. Product whose warranty/quality stickers, product serial number plates or electronic serial numbers have been removed, altered or rendered illegible; or
6. Product purchased, used, serviced, or shipped for repair from outside the United States of America or Canada, or used for commercial or institutional purposes (including but not limited to Products used for rental purposes); or
7. Product returned without a valid proof of purchase (see item 2 on the next page); or
8. Charges for installation or set up, adjustment of customer controls, and installation or repair of systems outside the unit.

How do you get warranty service?

To obtain warranty service in the USA, please visit our website at www.vtechphones.com or call 1 (800) 595-9511. In Canada, go to www.vtechcanada.com or call 1 (800) 267-7377.

NOTE: Before calling for service, please review the user's manual - a check of the Product's controls and features may save you a service call.

Except as provided by applicable law, you assume the risk of loss or damage during transit and transportation and are responsible for delivery or handling charges incurred in the transport of the Product(s) to the service location. VTech will return repaired or replaced Product under this limited warranty. Transportation, delivery or handling charges are prepaid. VTech assumes no risk for damage or loss of the Product in transit. If the Product failure is not covered by this limited warranty, or proof of purchase does not meet the terms of this limited warranty, VTech will notify you and will request that you authorize the cost of repair prior to any further repair activity. You must pay for the cost of repair and return shipping costs for the repair of Products that are not covered by this limited warranty.

What must you return with the Product to get warranty service?

1. Return the entire original package and contents including the Product to the VTech service location along with a description of the malfunction or difficulty; and
2. Include a "valid proof of purchase" (sales receipt) identifying the Product purchased (Product model) and the date of purchase or receipt; and
3. Provide your name, complete and correct mailing address, and telephone number.

Other limitations

This warranty is the complete and exclusive agreement between you and VTech. It supersedes all other written or oral communications related to this Product. VTech provides no other warranties for this Product. The warranty exclusively describes all of VTech's responsibilities regarding the Product. There are no other express warranties. No one is authorized to make modifications to this limited warranty and you should not rely on any such modification.

State/Provincial Law Rights: This warranty gives you specific legal rights, and you may also have other rights, which vary from state to state or province to province.

Limitations: Implied warranties, including those of fitness for a particular purpose and merchantability (an unwritten warranty that the Product is fit for ordinary use) are limited to one year from the date of purchase. Some states/provinces do not allow limitations on how long an implied warranty lasts, so the above limitation may not apply to you. In no event shall VTech be liable for any indirect, special, incidental, consequential, or similar damages (including, but not limited to lost profits or revenue, inability to use the Product or other associated equipment, the cost of substitute equipment, and claims by third parties) resulting from the use of this Product. Some states/provinces do not allow the exclusion or limitation of incidental or consequential damages, so the above limitation or exclusion may not apply to you.

Please retain your original sales receipt as proof of purchase.

FCC, ACTA and IC regulations

FCC Part 15

This equipment has been tested and found to comply with the requirements for a Class B digital device under Part 15 of the Federal Communications Commission (FCC) rules. These requirements are intended to provide reasonable protection against harmful interference in a residential installation. This equipment generates, uses and can radiate radio frequency energy and, if not installed and used in accordance with the instructions, may cause harmful interference to radio communications. However, there is no guarantee that interference will not occur in a particular installation. If this equipment does cause harmful interference to radio or television reception, which can be determined by turning the equipment off and on, the user is encouraged to try to correct the interference by one or more of the following measures:

- Reorient or relocate the receiving antenna.
- Increase the separation between the equipment and receiver.
- Connect the equipment into an outlet on a circuit different from that to which the receiver is connected.
- Consult the dealer or an experienced radio/TV technician for help.

Changes or modifications to this equipment not expressly approved by the party responsible for compliance could void the user's authority to operate the equipment.

This device complies with Part 15 of the FCC rules. Operation is subject to the following two conditions:

(1) this device may not cause harmful interference, and (2) this device must accept any interference received, including interference that may cause undesired operation. Privacy of communications may not be ensured when using this telephone.

To ensure safety of users, the FCC has established criteria for the amount of radio frequency energy that can be safely absorbed by a user or bystander according to the intended usage of the product. This product has been tested and found to comply with the FCC criteria. The handset may be safely held against the ear of the user. The telephone base shall be installed and used such that parts of the user's body other than the hands are maintained at a distance of approximately 20 cm (8 inches) or more.

This Class B digital apparatus complies with Canadian ICES-003.

FCC Part 68 and ACTA

This equipment complies with Part 68 of the FCC rules and with technical requirements adopted by the Administrative Council for Terminal Attachments (ACTA). The label on the back or bottom of this equipment contains, among other things, a product identifier in the format US:AAAEQ##TXXXX. This identifier must be provided to your telephone service provider upon request.

The plug and jack used to connect this equipment to premises wiring and the telephone network must comply with applicable Part 68 rules and technical requirements adopted by ACTA. A compliant telephone cord and modular plug is provided with this product. It is designed to be connected to a compatible modular jack that is also compliant. An RJ11 jack should normally be used for connecting to a single line and an RJ14 jack for two lines. See the installation instructions in the user's manual.

The Ringer Equivalence Number (REN) is used to determine how many devices you may connect to your telephone line and still have them ring when you are called. The REN for this product is encoded as the 6th and 7th characters following the US: in the product identifier (e.g., if ## is 03, the REN is 0.3). In most, but not all areas, the sum of all RENs should be five (5.0) or less. For more information, please contact your telephone service provider.

This equipment may not be used with Party Lines. If you have specially wired alarm dialing equipment connected to your telephone line, ensure the connection of this equipment does not disable your alarm equipment. If you have questions about what will disable alarm equipment, consult your telephone service provider or a qualified installer.

If this equipment is malfunctioning, it must be unplugged from the modular jack until the problem has been corrected. Repairs to this telephone equipment can only be made by the manufacturer or its authorized agents. For repair procedures, follow the instructions outlined under the Limited warranty.

If this equipment is causing harm to the telephone network, the telephone service provider may temporarily discontinue your telephone service. The telephone service provider is required to notify you before interrupting service. If advance notice is not practical, you will be notified as soon as possible. You will be given the opportunity to correct the problem and the telephone service provider is required to inform you of your right to file a complaint with the FCC. Your telephone service provider may make changes in its facilities, equipment, operation, or procedures that could affect the proper functioning of this product. The telephone service provider is required to notify you if such changes are planned.

If this product is equipped with a corded or cordless handset, it is hearing aid compatible.

If this product has memory dialing locations, you may choose to store emergency telephone numbers (e.g., police, fire, medical) in these locations. If you do store or test emergency numbers, please:

Remain on the line and briefly explain the reason for the call before hanging up.

Perform such activities in off-peak hours, such as early morning or late evening.

Industry Canada

Operation is subject to the following two conditions: (1) this device may not cause harmful interference, and (2) this device must accept any interference, including interference that may cause undesired operation.

The term "IC:" before the certification/registration number only signifies that the Industry Canada technical specifications were met.

The Ringer Equivalence Number (REN) for this terminal equipment is 0.1. The REN is an indication of the maximum number of devices allowed to be connected to a telephone interface. The termination on an interface may consist of any combination of devices subject only to the requirement that the sum of the RENs of all the devices does not exceed five.

This product meets the applicable Industry Canada technical specifications.

Technical specifications

Transmit frequency	Handset: 1921.536-1928.448 MHz Telephone base: 1921.536-1928.448 MHz
Channels	5
Nominal effective range	Maximum power allowed by FCC and IC. Actual operating range may vary according to environment conditions at the time of use.
Power requirements	Handset: 2.4V Ni-MH battery Telephone base: 6V DC @ 400mA Charger: 6V AC @ 300mA
Memory	Handset directory: 200 memory locations; up to 30 digits and 15 characters Handset caller ID log: 50 memory locations; up to 24 digits and 15 characters

The *Bluetooth*[®] word mark and logos are owned by Bluetooth SIG, Inc. and any use of such marks by VTech Holdings Limited is under license. VTech Holdings Limited is a member of Bluetooth SIG, Inc. Other trademarks and trade names are those of their respective owners.

VTECH TELECOMMUNICATIONS LTD.

A member of THE VTECH GROUP OF COMPANIES.

Distributed in the U.S.A. by VTech Communications, Inc., Beaverton, Oregon 97008.

Distributed in Canada by VTech Technologies Canada Ltd., Richmond, B.C. V6W 1L5.

VTech is the registered trademark of VTech Holdings Limited.

Copyright © 2012 for VTECH TELECOMMUNICATIONS LTD.

All rights reserved. Printed in China.

91-004788-040-100