



Important Safety Instructions

When using your telephone equipment, basic safety precautions should always be followed to reduce the risk of fire, electric shock and injury, including the following:

1. Read and understand all instructions.
2. Follow all warnings and instructions marked on the product.
3. Unplug this product from the wall outlet before cleaning. Do not use liquid cleaners or aerosol cleaners. Use a damp cloth for cleaning.
4. Do not use this product near water (for example, near a bath tub, kitchen sink, or swimming pool).
5. Do not place this product on an unstable cart, stand, or table. The product may fall, causing serious damage to the product.
6. Slots and openings in the cabinet and the back or bottom are provided for ventilation. To protect it from overheating, these openings must not be blocked by placing the product on the bed, sofa, rug, or other similar surface. This product should never be placed near or over a radiator or heat register. This product should not be placed in a built-in installation where proper ventilation is not provided.
7. This product should be operated only from the type of power source indicated on the marking label. If you are not sure of the type of power supply to your home, consult your dealer or local power company.
8. Do not allow anything to rest on the power cord. Do not locate this product where the cord will be abused by persons walking on it.
9. Never push objects of any kind into this product through cabinet slots as they may touch dangerous voltage points or short out parts that could result in a risk of fire or electric shock. Never spill liquid of any kind on the product.
10. To reduce the risk of electric shock, do not disassemble this product. If service or repair work is required, contact **VTech** Customer Service at **1-800-595-9511**. Opening or removing cabinet parts other than specified access doors may expose you to dangerous voltages or other risks. Incorrect reassembling can cause electric shock when the appliance is subsequently used.
11. Do not overload wall outlets and extension cords as this can result in the risk of fire or electric shock.
12. Unplug this product from the wall outlet:
 - a) When the power supply cord or plug is damaged or frayed.
 - b) If liquid has been spilled into the product.
 - c) If the product has been exposed to rain or water.
 - d) If the product does not operate normally by following the operating instructions. Adjust only those controls that are covered by the operating instructions because improper adjustment of other controls may result in damage and will often require extensive work to restore the product to normal operation.
 - e) If the product has been dropped and the cabinet has been damaged.
 - f) If the product exhibits a distinct change in performance.
13. Avoid using a telephone (other than a cordless type) during an electrical storm. There may be a remote risk of electric shock from lightning.
14. Do not use the telephone to report a gas leak in the vicinity of the leak.



If you have questions about this product, or if you're having difficulty with setup or operation, do not return your phone to the store. Call our Customer Support Center at:

1-800-595-9511

In Canada, call

1-800-267-7377





Parts Check List

- | | |
|---------------------|--------------------------|
| 1. Base Unit | 6. Base AC Power Adapter |
| 2. Corded Handset | 7. Telephone Line Cord |
| 3. Handset Cord | 8. Belt Clip |
| 4. Cordless Handset | 9. Owner's Manual |
| 5. Handset Charger | 10. Battery Pack |

To purchase replacement battery packs, call VTech Communications inc. at 1-800-595-9511. In Canada, call VTech Electronics Ltd. at 1-800-267-7377.



Corded Handset



Base Unit



Cordless Handset

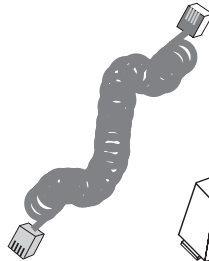

Handset Cord

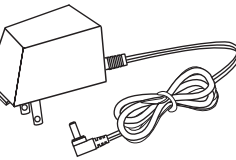

Base AC Power Adapter

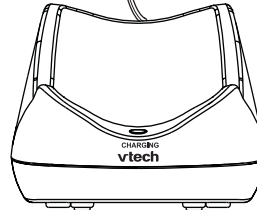

Handset Charger



Telephone Line Cord

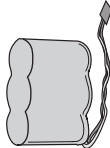

Battery Pack

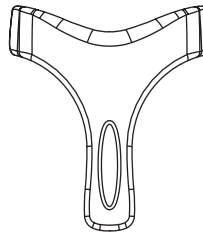

Belt Clip



Owner's Manual



The Base Unit Layout

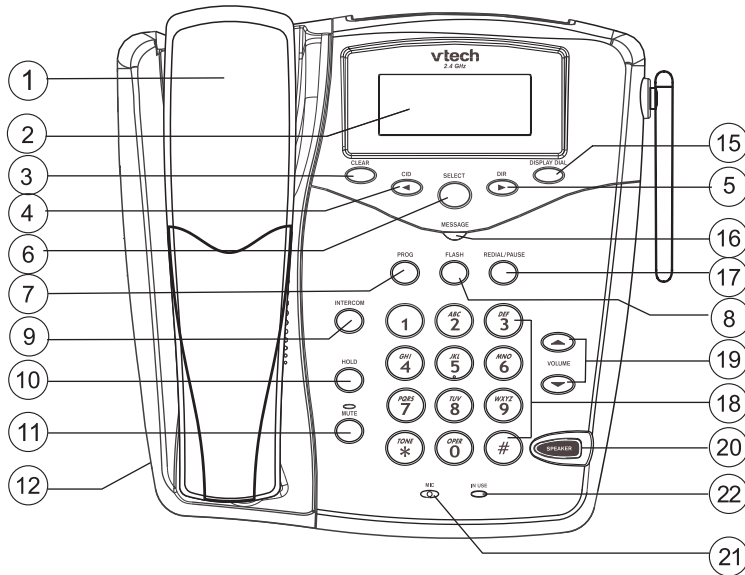
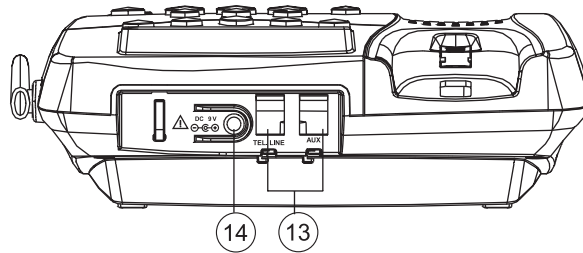

1. Corded Handset
2. LCD Display
3. Clear
4. CID (Caller ID) / ◀
5. DIR (Directory) / ▶
6. Select
7. Program
8. Flash
9. Intercom
10. Hold
11. Mute

12. Handset Cord Jack
13. Line In/Out Jacks
14. Power Jack
15. Display Dial
16. Message LED
17. Redial/Pause
18. Dialing Keys
19. Volume Keys
20. Speakerphone
21. Microphone
22. In Use LED

The Cordless Handset Layout

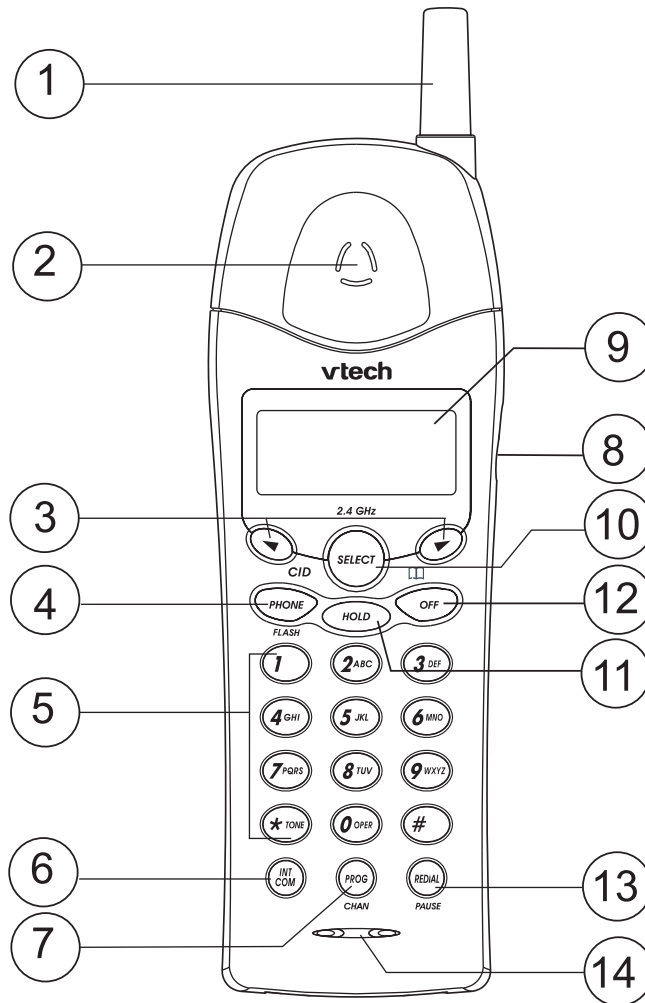

- | | |
|-------------------------------|----------------------|
| 1. Antenna | 8. Headset Jack |
| 2. Earpiece | 9. LCD Display |
| 3. Volume/Scroll Keys | 10. Select |
| 4. Phone (Flash) | 11. Hold |
| 5. Dialing Keys (0-9, *, #) | 12. Off |
| 6. Intercom | 13. Redial (Pause) |
| 7. Program (Channel) | 14. Microphone |



Setup

Connecting power to Base Unit/Handset Charger

1. Plug the AC power adapter into an electrical outlet, and the DC connector into the back of the Base Unit.

To AC outlet

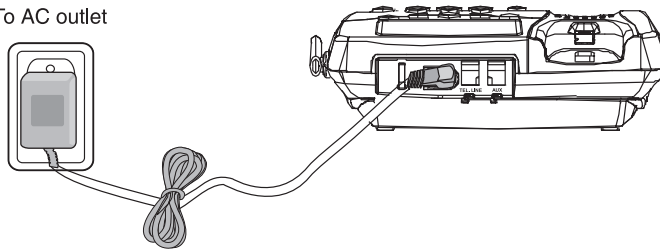

2. Choose the location for your Handset Charger, and plug its power supply into an electrical outlet.

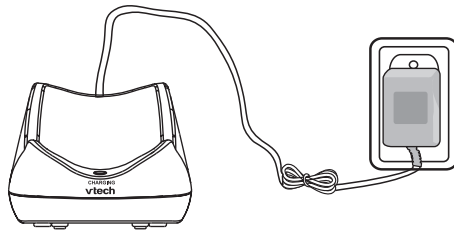

3. Using the coiled Handset Cord, connect the corded Handset to the Base Unit. The corded Handset jack is on the front left edge of the Base.

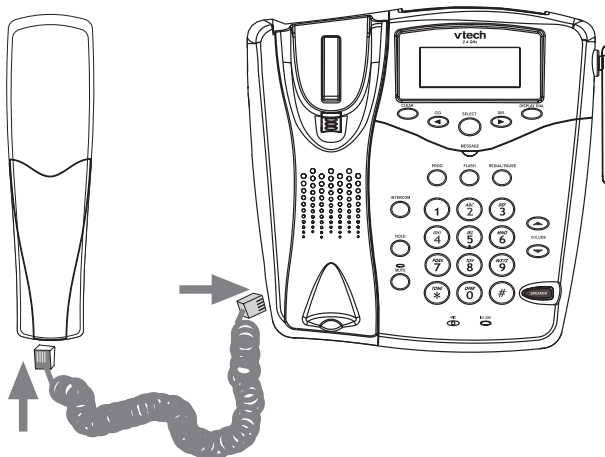

Setup

Installation of Battery Pack in Handset

Follow the steps below:

1. Remove battery compartment cover by pressing on the indentation and sliding downward.
2. Align the two holes in the plug with the socket pins, then snap the plug into place.
3. Snap the battery pack in place with the wires in the lower left corner, along the bottom of the battery pack.
4. Replace cover by sliding it up into place.
5. Place the Handset in the Charger, and allow it to charge for 12 hours. You can use the Base Handset or Speakerphone in the meantime.

Note: If you charge the cordless Handset while the Base Unit is not connected to power, the **CHARGING** LED on the cradle will flash rapidly.

Note: With a fully charged battery pack, your **VT2498** Cordless Handset will deliver up to 6 hours of continuous talk time, or up to 6 days of standby time (off the charge cradle, but not in use). Your results can vary, and may be less than the quoted maximums.

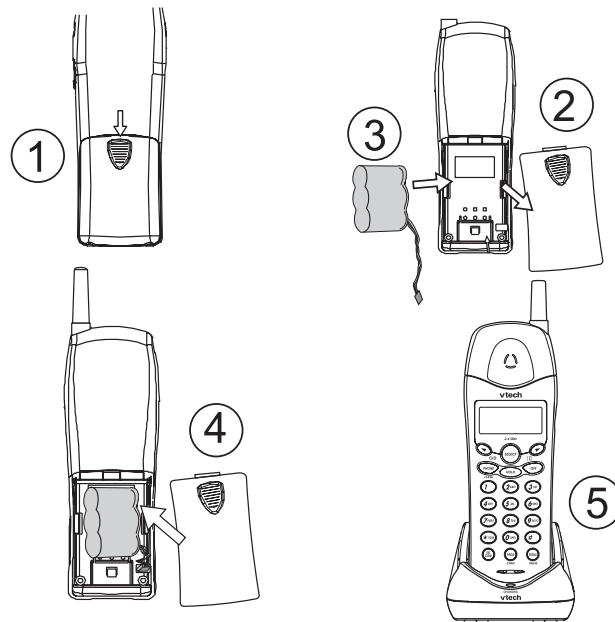



Setup

IMPORTANT:

1. Do not dispose of a battery pack in a fire, the cell may explode.
2. Do not open or mutilate the battery pack. Toxic substances may be released causing harm to eyes or skin.
3. Exercise care in handling battery packs in order to prevent an accidental short of the charge contacts, potentially causing the battery pack to overheat.
4. Do not dispose of this battery pack into household garbage. Please refer to the information concerning proper battery recycling.

Connecting to Phone Line

Plug one end of the telephone line cord into the **TEL. LINE** jack on the back of the Base Unit. Plug the other end of this cord into the wall jack.

The **AUX** jack can be used for connection to an answering device, fax or computer modem.

Checking for Dial Tone

From Cordless Handset

After the battery is charged, press **PHONE** on the Handset. **PHONE ON** will appear on the Handset display, and you will hear dial tone. If not, see **In Case of Difficulty**.

From Base

Pick up the corded Handset or press the **SPEAKER** key. **PHONE** or **SPEAKERPHONE** will appear on the Base display, and you will hear dial tone. If not, see **In Case of Difficulty**.

Tone/Pulse Selection

Your **VT2498** is preset for **tone** dialing.

See **Base Menu - Setting Dial Mode** for details.

 **CAUTION:** Use only the Vtech power supply provided with your telephone.

IMPORTANT:

FOR MAXIMUM PERFORMANCE OF YOUR CORDLESS TELEPHONE SYSTEM:

1. Choose a central location for your Base Unit.
2. Install your Base Unit and Extension Handset away from electronic equipment, such as personal computers, television sets and microwave ovens.
3. In locations where there are multiple cordless telephones, separate base units as much as possible.
4. Install your telephone equipment away from heat sources and sunlight.
5. Avoid excessive moisture, dust or extreme cold.

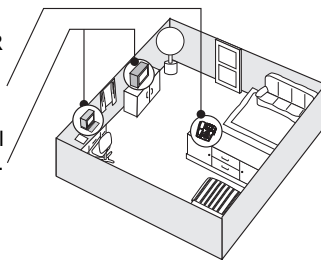

Wall Mounting (optional)

Base Unit

1. Release the bracket from its desk mount position on the underside of the Base by pressing as shown below:

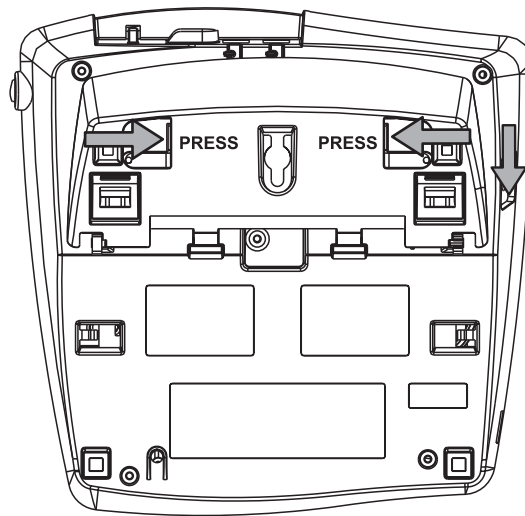

2. Turn the bracket down and snap it into the 2 holders on the lower portion of the Base Unit's underside.
3. With the corded Handset out of the cradle, remove the reversible hook by pushing upwards, then rotate it 180 degrees and slide it back in place.

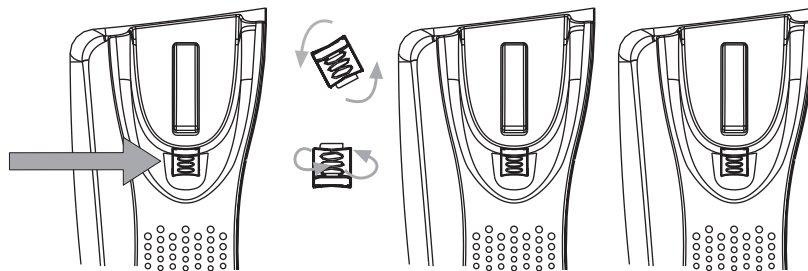



Wall Mounting (optional)

4. Connect the telephone line cord to the jack labeled **TEL. LINE** on the back of the Base.
5. Connect the power cord to the jack labeled **DC 9V** on the back of the Base.
6. Wrap the telephone line cord around the posts on the bottom of the Base.
7. Connect the corded Handset to the Base.
8. Connect the telephone line cord to the modular telephone jack.
9. Plug the power cord into the electrical outlet.
10. Mount the Base on the wall.
 - a) Align holes on Base with mounting studs on wall jack.
 - b) Pull Base down on mounting studs until it locks into place.

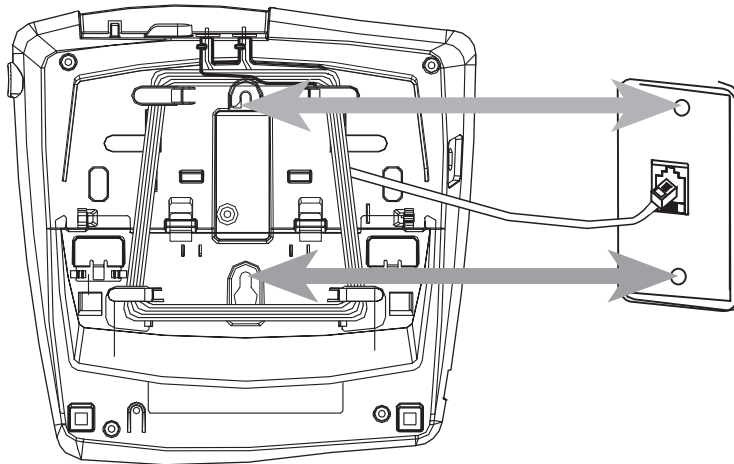

Wall Mounting (optional)

Handset Charger

- 1 Plug the AC adapter into an electrical outlet.
- 2 Mount the Handset Charger on the wall. Position the Handset Charger so the mounting studs will fit into the holes on the back of the Charger. Slide Handset Charger down on the mounting studs until it locks into place.

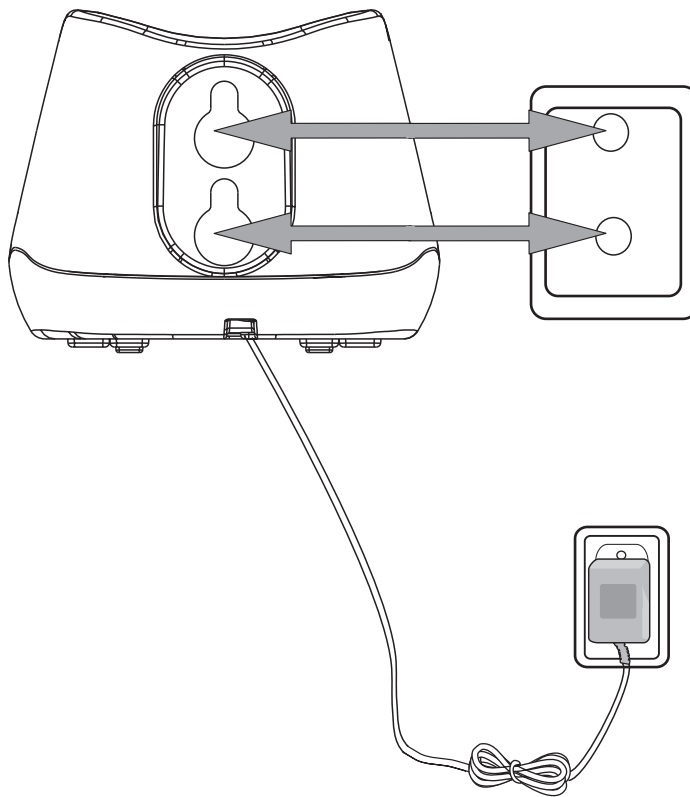

Base Features

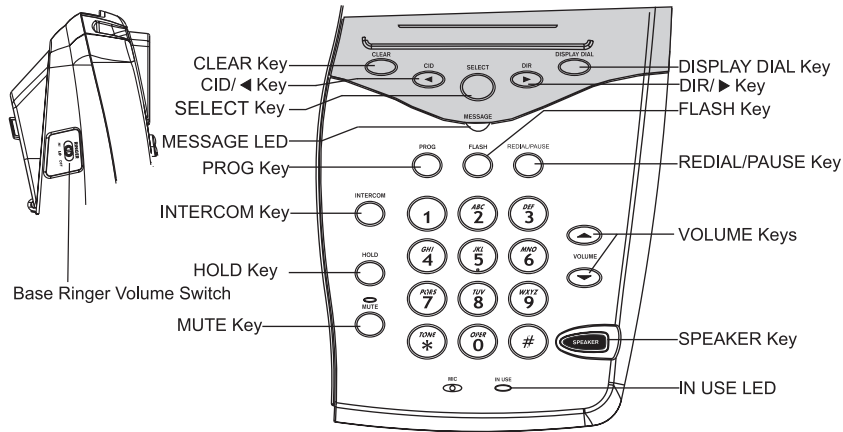

Base Ringer Volume Switch

- * Located on the left edge of the Base, select from **HIGH**, **LOW** or **OFF**.

CLEAR Key

- * Press **CLEAR** to return the Base display to the idle mode.

CID/◀ Key

- * Press this key to enter access Caller ID and Call Waiting ID records.
- * While entering digits during predialing or Directory programming, press CID/◀ to backspace.

SELECT Key

- * Used in connection with **PROG** for Base programming.

MESSAGE LED

- * Flashes to alert you to new voice mail messages.

PROG Key

- * Press this key to program names and numbers in the Base directory, change dial mode (tone/pulse), or clear Message Waiting alert.

INTERCOM Key

- * Press this key to signal the cordless Handset. Both Base and Handset emit a paging tone, and display: ***** PAGING *****.
- * Pressing **INT. COM** at the cordless Handset will engage the Base and Handset in an Intercom call. Both screens will display: **INTERCOM**.
- * Press **INTERCOM** at the Base or **OFF** at the cordless Handset to end the intercom call.

Base Features

HOLD Key

- * Press **HOLD** to place your call on hold. The **IN USE** light flashes.
- * Press **HOLD** or **SPEAKER** to return to the call.
- * You can also return to the call by picking up the corded Handset.
- * You can also return to the call by pressing **PHONE** on the cordless Handset.

MUTE Key

- * Press **MUTE** to disable the microphone. You can still hear the other party.
- * The **MUTE** LED will glow steadily.
- * Press **MUTE** again to return to the two-way conversation.

DISPLAY DIAL Key

- * Press to dial the number displayed on the Base screen.

DIR/▶ Key

- * Press this key to access the Phone Book Directory.
- * While entering digits during Name programming, press **DIR/▶** to skip to the next space.

FLASH Key

- * Press to access services, such as Call Waiting, while on a call.

REDIAL Key

- * Press to call the last number dialed at the Base (up to 32 digits).

VOLUME Keys

- * Adjust the Speakerphone or corded Handset volume. There are **8** volume levels.

SPEAKER Key

- * Press to either make or receive a Speakerphone call. The **SPEAKER** key illuminates when you are on an active speakerphone call.

IN USE LED

- * Glows when the corded Handset, Base or cordless Handset is on an active call.
- * Flashes slowly when a call is on hold.

Cordless Handset Features

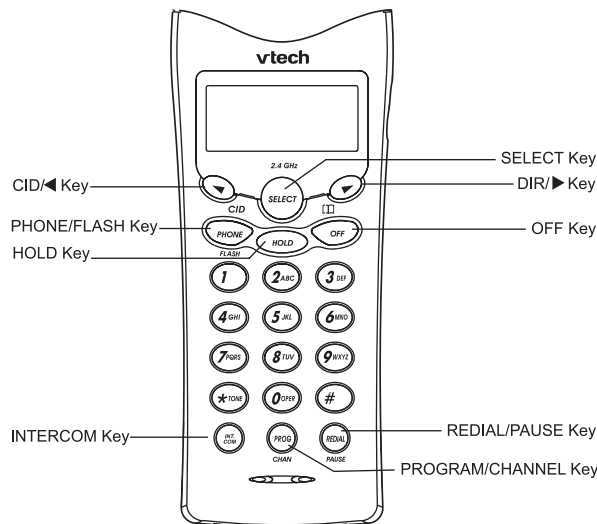

CID/◀ Key

- * While on a call, press this key to lower the Handset volume.
- * Press this key to access Caller ID and Call Waiting ID records.
- * While entering digits during predialing or Directory programming, press **CID/◀** to backspace.

PHONE/FLASH Key

- * Press **PHONE/FLASH** to make or answer a call.
- * While on a call, press this key to access services such as Call Waiting.

HOLD Key

- * Press this key to place your call on Hold.
- * Press either **HOLD** or **PHONE/FLASH** to return to the call.
- * You can also press **SPEAKER** at the Base, or pick up the corded Handset.

INTERCOM Key

- * Press this key to signal the Base. The Base will emit a paging tone, and both Base and cordless Handset will display: **** PAGING ****.
- * Press **INTERCOM** at the Base, or pick up the corded Handset to engage in an Intercom call. Both screens will display: **INTERCOM**.
- * Press **INTERCOM** at the Base, hang up the corded Handset, or press **OFF** at the cordless Handset to end the intercom call.

DIR/▶ Key

- * While on a call, press this key to raise the Handset volume.
- * Press this key to access the Phone Book Directory.
- * While entering digits during *Name* programming, press **DIR/▶** to skip to the next space.

Cordless Handset Features

SELECT Key

- * Use in conjunction with **PROG/CHAN** for Handset programming.

OFF Key

- * Press **OFF** to end your call.
- * Press **OFF** to exit programming and return to the idle screen.
- * Press **OFF** to end a page.

REDIAL/PAUSE Key

- * Press this key to display the last number dialed, up to 32 digits. You can then press **PHONE** to complete the call.
- * During Directory programming, press **REDIAL/PAUSE** to place a 2 second pause in a dialing sequence. Each additional press adds another 2 seconds to the pause.

PROG/CHAN (Program/Channel) Key

- * In the idle (Off) mode, press this key to enter programming mode.
- * During an active call, press this key to switch to a clearer channel.

Operating Instructions

Cordless Handset Menu

In the idle mode, press **PROG/CHAN**, then ◀ or ▶ to scroll through the following options:

- | | |
|-------------------------|--|
| DIRECTORY | for programming Name and Numbers in Phone Book Memory. |
| RINGER | select a ring style, or shut the Handset ringer off. |
| DATE/TIME | for setting the Handset date and time. |
| MESSAGES WAITING | for clearing the Message Waiting alert. |

Setting Date and Time

Note: Incoming Caller ID will set the Handset date and time. However, if you want to set the day and time manually:

- * Press **PROG/CHAN**, then press ◀ or ▶ and scroll to **DATE/TIME**.
- * Press **SELECT**. The month blinks. Press ◀ or ▶ to select the current month.
- * Press **SELECT**. The day blinks. Press ◀ or ▶ to select the current day.
- * Press **SELECT**. The hour blinks. Press ◀ or ▶ to select the current hour.
- * Press **SELECT**. The minute blinks. Press ◀ or ▶ to select the current minute.
- * Press **SELECT**. AM or PM blinks. Press ◀ or ▶ to select **AM** or **PM**.
- * Press **SELECT**. You will hear a confirmation beep.

Clearing MESSAGES WAITING Alert

After reviewing all of your new voice mailbox messages, if the **MESSAGES WAITING** alert is still on, do the following at the cordless Handset:

- * Press **PROG/CHAN**, then press ◀ or ▶ and scroll to **MESSAGES WAITING**.
- * Press **SELECT**. The screen will display **LIGHT OFF: YES**.
- * Press **SELECT** to clear the **Messages Waiting** alert.



Operating Instructions

Base Menu

In the idle mode, press **PROG**, then ◀ or ▶ to scroll through the following options:

- DIRECTORY** for programming Name and Numbers in Phone Book Memory.
- DIAL MODE** choose Tone or Pulse
- MESSAGES WAITING** for clearing the Message Waiting alert.

Setting Dial Mode (preset to TONE)

- * Press **PROG**, then press ◀ or ▶ and scroll to **DIAL MODE**.
- * Press **SELECT**, then press ◀ or ▶ to choose **TONE** or **PULSE**.
- * Press **SELECT** to confirm your choice.

Clearing MESSAGES WAITING Alert

After reviewing all of your new voice mailbox messages, if the **MESSAGES WAITING** alert is still on, do the following at the Base:

- * Press **PROG**, then press ◀ or ▶ and scroll to **MESSAGES WAITING**.
- * Press **SELECT**. The screen will display **LIGHT OFF: YES**.
- * Press **SELECT** to clear the Messages Waiting alert.

What is MESSAGE WAITING Alert?

If you subscribe to telephone company voice mail, the phone company may provide a special signal that triggers your **VT2498** to alert you to new messages. On the Base, the **MESSAGE** light will illuminate, and on both the cordless Handset and Base, **MESSAGES WAITING** will be displayed. Once you have called your voice mail service and listened to all new messages, the alerts will be turned off until a new message is received.





Operating Instructions

Making a Call from the Base Unit

- * Pick up the corded Handset or press **SPEAKER**, then dial the number;
- OR-
- * Dial the number first. Use **CID/** to backspace if you make a mistake.
- * Press **DISPLAY DIAL**.

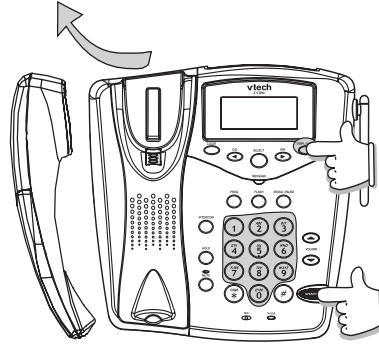

Making a Call from the Cordless Handset

- * Press **PHONE/FLASH**, then dial the number;
- OR-
- * Dial the number first; use **CID/** to backspace if you make a mistake.
- * Press **PHONE/FLASH** to dial the displayed number.

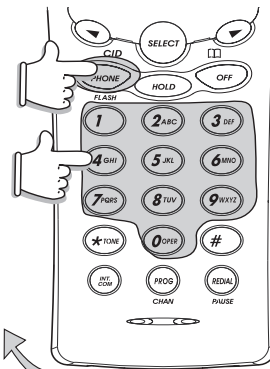

Answering a Call from the Base Unit

- * Pick up the corded Handset or press **SPEAKER**.



Answering a Call from the Cordless Handset

- * Press any key except **OFF**.

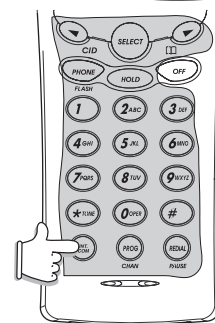



Operating Instructions

Ending a Base Unit Call

* Return the corded Handset to the cradle, or press **SPEAKER**.



Ending a call when using the Cordless Handset

* Press **OFF**, or return the Handset to its remote charger.

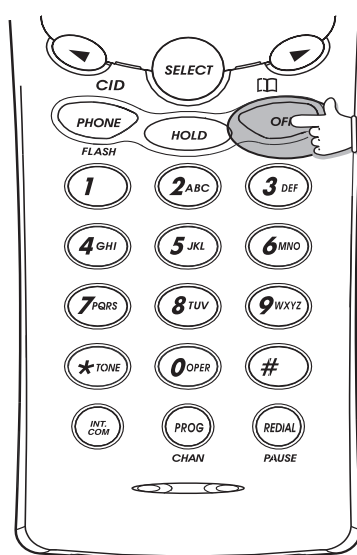



Operating Instructions

Intercom

From Cordless Handset to Base:

- * Press **INTERCOM** on the cordless Handset. The screens display **** PAGING ****.
- * Press **INTERCOM** on the Base, or pick up the corded Handset.
- * Press **OFF** on the cordless Handset, **INTERCOM** on the Base, or return the corded Handset to the cradle to end the Intercom call.

From Base to Cordless Handset:

- * Press **INTERCOM** on the Base. The screens display **** PAGING ****.
- * Press **INTERCOM** on the cordless Handset.
- * Press **OFF** on the cordless Handset or **INTERCOM** on the Base to end the intercom call.

Transferring a Call from Cordless Handset to Base using INTERCOM:

- * Press **HOLD** to place your call on hold.
- * Press **INTERCOM** on the cordless Handset.
- * If the corded Handset answers the intercom call, you can announce that there's a call on Hold, then press **OFF** on the cordless Handset. The person using the corded Handset can then press **HOLD** to continue the call.
- * If the Base Speakerphone answers the Intercom call, after the cordless Handset hangs up, press either **HOLD** or **SPEAKERPHONE** to continue the call.

Transferring a Call from Speakerphone or Corded Handset to Cordless Handset:

- * Press **HOLD** to place your call on hold.
- * Press **INTERCOM** on the Base.
- * When the cordless Handset answers the Intercom call, you can announce that there's a call on Hold, then press **INTERCOM** if using the Speakerphone, or hang up the corded Handset. The person using the cordless Handset can then press **HOLD** to continue the call.

Note: The cordless Handset and Base (either Speakerphone or corded Handset) can be conferenced on a call at the same time.





Operating Instructions

Handset Ringer Style

You can select from 4 different Handset ringer styles, or turn the Handset ringer off. With the Handset in the idle (Off) mode:

- * Press **PROG/CHAN**.
- * Press **▶** until the screen displays: **RINGER: _____**
- * Press **SELECT**. The current selection will blink.
- * Press **◀** or **▶** to sample each of the ring styles, or choose **OFF**.
- * Press **SELECT** to confirm your choice.

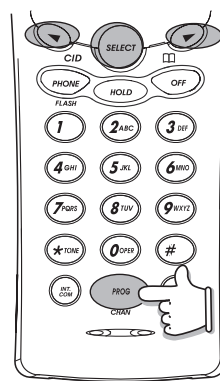

Temporary Tone Dialing (Base or Cordless Handset)

If you have dial pulse (rotary) service, you can temporarily switch to touch tone dialing during a call by pressing the * **TONE** key. This is useful if you need to send tone signals for access to banking or long distance services:

- * Make your call in the pulse (rotary) mode.
- * After connecting, press the * **TONE** key. Now, all subsequent key presses will be in **tone**.
- * Once you hang up, the phone returns to pulse (rotary) mode.

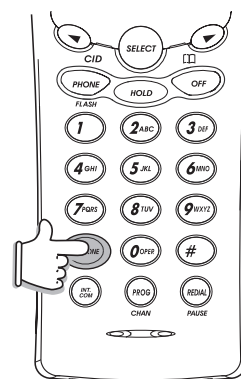



Operating Instructions

Base Display Messages

Screen Displays:	When:
BUSY	Base Intercom denied since cordless Handset is in use.
HOLD	Call was placed on Hold.
INTERCOM	Base is in intercom mode with cordless Handset.
MESSAGES WAITING	New unplayed messages are in your voice mailbox.
MUTE	Microphone is muted.
NEW 02 OLD 05	New and previously viewed CID records.
** PAGING **	Base paging Handset or Handset paging Base.
PHONE	Corded Handset is in use.
** RINGING **	There is a call coming in.
SPEAKERPHONE	Base Speakerphone is in use.
VOLUME ■ ■ ■	Speakerphone or corded Handset volume level.



Cordless Handset Display Messages

Screen Displays:	When:
BATTERY LOW	The battery needs to be recharged.
CONNECTING ...	Cordless Handset is waiting for a dial tone.
HOLD	Call was placed on Hold.
INTERCOM	Cordless Handset is in intercom mode with Base.
MESSAGES WAITING	New unplayed messages are in your voice mailbox.
NEW 02 OLD 05	New and previously viewed CID records.
** PAGING **	Base paging Handset or Handset paging Base.
PHONE ON	Cordless Handset is in use.
** RINGING **	There is a call coming in.
VOLUME ■ ■ ■	Cordless Handset volume level.





Phone Book Directory

Both the Base and cordless Handset can independently store **50** names and phone numbers, up to 24 digits long. Storing a name and phone number in the Base Unit's Phone Book Directory has no effect on the cordless Handset, and vice versa. The Directory stores the names alphabetically. If you want your directory to alphabetize by last name, enter the names **last** name first.

NOTE: Press **OFF** (on the cordless Handset) or **CLEAR** (on the Base) to exit Directory mode.

Storing a Number/Name in the Phone Book Directory

- * Press **PROG** on the Base, or **PROG/CHAN** on the Handset. The screen displays **DIRECTORY**.
- * Press **SELECT**. The screen displays **ENTER NAME**.
- * Using the chart below, enter up to 15 characters for the name you are storing with the number. Use ◀ to backspace and ▶ add a space.

NOTE: When enter two or more consecutive letters that are on the same key, you will need to use the space (▶) key between them. The space key is not necessary for when entering letters from different keys.



Dial key	Presses					
	1	2	3	4	5	6
1	1					
2	A	B	C	2		
3	D	E	F	3		
4	G	H	I	4		
5	J	K	L	5		
6	M	N	O	6		
7	P	Q	R	S	7	
8	T	U	V	8		
9	W	X	Y	Z	9	
0	0					
*	*					
#	&	'	,	-	.	#





Phone Book Directory

- * When you finish entering the name, press **SELECT**. The screen displays **ENTER NUMBER**.
- * Enter the telephone number. Press **◀** to backspace if you make a mistake. Press **REDIAL/PAUSE** to add a 2-second pause to the dialing sequence. Multiple presses of the **REDIAL/PAUSE** key will increase the pause in two second increments;
- OR -
- To Save the Last Number Dialed:**
Instead of entering the telephone number, press **REDIAL/PAUSE** to display the last number dialed.
- * Press **SELECT**. If you are programming at the Base, your number has been stored.
- * If you are programming the cordless Handset, the screen will display: **DISTINCT RING ? N**. Use **◀** or **▶** key to choose **Yes** or **No**. Choosing **Yes** will cause the cordless Handset to emit a different ring pattern if the number you entered comes in via Caller ID (after the first ring).
- * Press **SELECT** to confirm your choice. A Phone Book entry with Distinctive Ring selected will display a **D** in the upper right corner of the screen.

NOTE: When phone book memory is full, any attempt to enter a new name/number will generate an error tone and **MEMORY FULL** on the display.

Edit a Number/Name Stored in the Directory

- * Press **▶** (M). **DIRECTORY** is displayed.
- * Press **◀** or **▶** to scroll for the desired entry;
- OR -
- * Press the key that has the first letter of the name on the desired record. Press the key again to scroll through all records in the letter range of that key. For example the **5JKL** key will cycle through all entries beginning with J, K, L and 5).
- * With the desired name displayed, press **SELECT**. Press **◀** or **▶** until **EDIT** flashes.

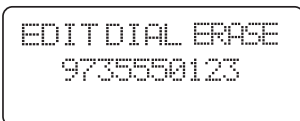

- * Press **SELECT**. The cursor is now flashing at the end of the name. Use the **◀**, **▶** and dial keys to edit the name. Press **SELECT**.
- * Now edit the phone number. When done, press **SELECT**. Now, make your Distinctive Ring selection. Press **SELECT** to save your edits.





Phone Book Directory

Deleting a Number/Name Stored in the Directory

- * Press **▶** (M). The screen displays **DIRECTORY**.
- * Press **◀** or **▶** to search for the desired entry, or press the key containing the first letter of the entry. Keep pressing the key if your desired entry is not the first one to come up.
- * With the desired entry displayed, press **SELECT**, then press **◀** or **▶** until **ERASE** flashes.

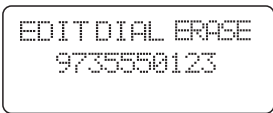

- * Press **SELECT**. The screen displays **ERASE NO YES**, along with the phone number.
- * Press **◀** or **▶** until **YES** flashes. Press **SELECT**. The Handset will beep to confirm deletion and display the next entry in memory.

Dialing from the Phone Book Directory

- * Press **▶** (M). The screen displays **DIRECTORY**.
- * Press **◀** or **▶** to search for the desired entry, or press the key containing the first letter of the entry. Keep pressing the key if your desired entry is not the first one to come up.
- * With the desired entry displayed, press **PHONE** on the cordless Handset or **DISPLAY DIAL** if you're dialing from the Base;
- OR -
- * Press **SELECT**. **DIAL** will be flashing on the display. Press **SELECT** to dial.

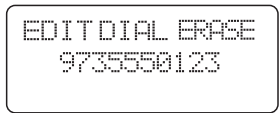



Caller ID Operation

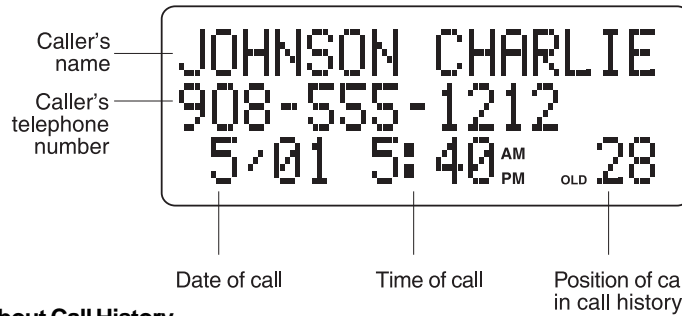

About Call History

This phone assigns each incoming call a number from 1 to 90. The most recent call will have the highest number. When the memory is full, the oldest call information is deleted to make room for new incoming call information.

For each call that comes in, the screen displays the following information between the first and second rings:

- Your caller's name (15 letters are sent by your telephone company)
- The caller's area code and telephone number
- The time and date of the call

If you answer a call before the information appears on the screen, it will not be in the call history. If there appears a * in the upper right corner of the screen, it signifies the caller has called you at least two times.

Note: Press **OFF** on the cordless Handset or **CLEAR** on the Base at any time to exit Call History.

Review Call History

The screen displays call information for about 15 seconds after it has been received.

1 Press ◀ (CID) to view call history. The screen displays

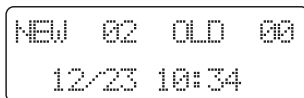

2 Use ◀ and ▶ to scroll through records in call history.





Caller ID Operation

Deleting Records from Call History Delete a Specific Call

- * Locate the record you want to delete from call history by following the steps in **Review Call History**.
- * Press **SELECT**. **ERASE** is flashing.

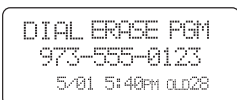

- * Press **SELECT**. The screen displays **ERASE NO YES ALL** and the telephone number.
- * Press **◀** or **▶** until **YES** flashes.
- * Press **SELECT**. The Handset will beep to confirm deletion.

Delete ALL Calls

- * While viewing call history, press **SELECT**, then press **◀** or **▶** until **ERASE** flashes.

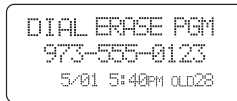

- * Press **SELECT**. The screen displays **ERASE NO YES ALL** and the telephone number. The current choice flashes.
- * Press **◀** or **▶** until **ALL** flashes, then press **SELECT**. The screen displays **ERASE ALL NO YES**. The current choice flashes.
- * Press **◀** or **▶** until **YES** flashes.
- * Press **SELECT**. You will hear a series of beeps confirming deletion.

Dial a Displayed Number

- * Locate the record you want to dial by following the steps in **Review Call History**.
- * To change the dialing string (4 choices: 7, 8, 10 or 11 digit dialing), press **#** until the correct sequence is displayed.
- * Press **PHONE** on the cordless Handset or **DISPLAY DIAL** if you're dialing from the Base;

-OR-

- * Press **SELECT**, then press **◀** or **▶** until **DIAL** flashes.

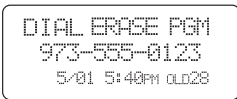

- * Press **SELECT**. The displayed number is dialed.





Caller ID Operation

Store a Call History Record in the Phone Book Directory

- * Locate the record you want to store from call history by following the steps in **Review Call History**.
- * To change the dialing string (4 choices: 7, 8, 10 or 11 digit dialing), press # until the correct sequence is displayed.
- * Press **SELECT**, then press ◀ or ▶ until PGM flashes.

```
DIAL ERASE PGM
973-555-0123
5/01 5:40PM OLD28
```

- * Press **SELECT**. Edit the Name, if desired.
- * Press **SELECT**. Edit the Number, if desired.
- * Press **SELECT**. Choose Distinctive Ring Yes or No by pressing ◀ or ▶.

```
DISTINCTIVE RING?Y
12/23 10:34
```

- * Press **SELECT**. You will hear a beep to confirm storage.



Display Screen Messages

PRIVATE NAME	The other party is blocking their name.
PRIVATE NUMBER	The other party is blocking their number.
PRIVATE CALLER	The other party is blocking their name and number.
UNKNOWN NAME	Your phone company is unable to receive the caller's name.
UNKNOWN NUMBER	Your phone company is unable to receive the caller's number.
UNKNOWN CALLER	Your phone company is unable to receive the caller's name and number.





Headset Operation

Your **VT2498** Cordless Handset is equipped with a 2.5mm Headset Jack for use with an optional accessory Headset for hands-free operation. If you choose to use the Headset option, you must obtain an optional accessory Headset, which is compatible with the **VT2498**.

To purchase a Headset, call VTECH Customer Service at 1-800-595-9511.

Once you have a compatible 2.5mm Headset, locate the Headset Jack on the **VT2498** Handset. Connect the plug on the Headset cord to the jack on the cordless Handset. The plug should fit securely. Do not force the connection.

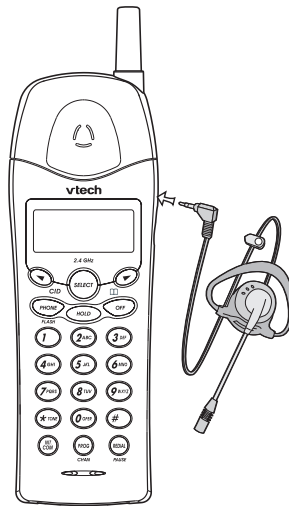

NOTE:

Whenever a compatible Headset is connected to the cordless Handset, the microphone on the Handset will be muted. This is done to limit the effect of background noise.

Many compatible Headsets have a reversible, monaural design. You can wear your Headset on either ear, leaving one ear free for room conversation.

Belt Clip

The **VT2498** is also equipped with a detachable belt clip. Align the pins on the inside edge of the clip with the notches on the sides of the Handset. The belt clip should snap securely into place. Do not force the connection.

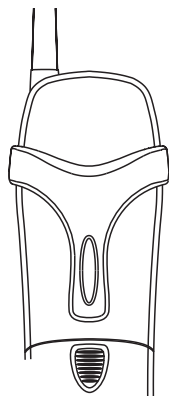



Maintenance

Taking Care Of Your Telephone

Your **VT2498** cordless telephone contains sophisticated electronic parts, so it must be treated with care.

Avoid rough treatment

Place the Handset down gently. Save the original packing materials to protect your telephone if you ever need to ship it.

Avoid water

Your telephone can be damaged if it gets wet. Do not use the Handset outdoors in the rain, or handle it with wet hands. Do not install your Base Unit near a sink, bathtub or shower.

Electrical storms

Electrical storms can sometimes cause power surges harmful to electronic equipment.
For your own safety, use caution when using electrical appliances during storms.

Cleaning your telephone

Your telephone has a durable plastic casing that should retain its luster for many years. Clean it only with a soft cloth slightly dampened with water or a mild soap. Do not use excess water or cleaning solvents of any kind.

Remember that electrical appliances can cause serious injury if used when you are wet or standing in water. If your Base Unit should fall into water, **DO NOT RETRIEVE IT UNTIL YOU UNPLUG THE POWER CORD AND TELEPHONE LINE CORDS FROM THE WALL.** Then pull the unit out by the unplugged cords.





In Case Of Difficulty

If you have difficulty operating your phone, the suggestions below should solve the problem. If you still have difficulty after trying these suggestions, call VTECH Communications at 1-800-595-9511. In Canada, call VTECH Electronics at 1-800-267-7377.

The Phone Doesn't Work At All

- Make sure the Power Cord is plugged in.
- Make sure the telephone line cord is plugged firmly into the Base Unit and the telephone wall jack.
- Make sure the batteries are properly charged. If **BATTERY LOW** is displayed, the battery pack needs charging.

No Dial Tone

- First check all the suggestions above.
- If you still don't hear a dial tone, disconnect the Base Unit from the telephone jack and connect a different phone. If there is no dial tone on that phone either, the problem is in your wiring or local service. Contact your local telephone company.

You Get Noise, Static, Or A Weak Signal Even When You're Near The Base Unit

- Household appliances plugged into the same circuit as the Base Unit can sometimes cause interference. Try moving the appliance or the Base Unit to another outlet.

You Get Noise, Static, Or A Weak Signal When You're Away From The Base Unit

- You may be out of range. Either move closer to the Base, or relocate the Base Unit.
- The layout of your home may be limiting the range. Try moving the Base Unit to another position.

The Handset Does Not Ring When You Receive A Call

- Make sure you have the Handset ringer activated. To set the ringer, see **Handset Ringer Style**.
- Make sure the telephone line cord is plugged firmly into the Base Unit and the telephone jack. Make sure the power cord is plugged in.
- You may be too far from the Base Unit.
- You may have too many extension phones on your telephone line to allow all of them to ring. Try unplugging some of the other phones.





In Case Of Difficulty

You Hear Other Calls While Using Your Phone

- Disconnect your Base Unit from the telephone jack, and plug in a regular telephone. If you still hear other calls, the problem is probably in your wiring or local service. Call your local telephone company.

You Hear Noise In The Handset, And None Of The Keys Or Buttons Work

- Make sure the power cord is plugged in.

Common Cure For Electronic Equipment

If the unit does not seem to be responding normally, then try putting the Handset in the cradle. If it does not seem to respond, do the following (in the order listed):

1. Disconnect the power to the Base.
2. Disconnect the Handset battery.
3. Wait a few minutes.
4. Connect power to the Base.
5. Re-install the battery pack, and return the Handset to the charge cradle.
6. After a few seconds, try using your Handset again.





Warranty Statement

What does this limited warranty cover?

- The manufacturer of this **VTECH** product, **VTECH Communications**, warrants to the holder of a valid proof of purchase (“Consumer” or “you”) that the product and all accessories provided by **VTECH** in the sales package (“Product”) are free from material defects in material and workmanship, pursuant to the following terms and conditions, when installed and used normally and in accordance with operation instructions. This limited warranty extends only to the Consumer for Products purchased and used in the United States of America.

What will VTECH Communications do if the Product is not free from material defects in materials and workmanship during the limited warranty period (“Materially Defective Product”)?

- During the limited warranty period, VTECH's authorized service representative will repair or replace at VTECH's option, without charge, a Materially Defective Product. If we repair this product, we may use new or refurbished replacement parts. If we choose to replace this product, we may replace it with a new or refurbished product of the same or similar design. VTECH will return repaired or replacement products to you in working condition. VTECH will retain defective parts, modules, or equipment. Repair or replacement of Product, at VTECH'S option, is your exclusive remedy. You should expect the repair or replacement to take approximately 30 days.

How long is the limited warranty period ?

- The limited warranty period for the product extends for ONE(1)YEAR from the date of purchase if we repair or replace a Materially Defective Product under the terms of this limited warranty. This limited warranty also applies to repaired or replacement Products for a period of either (a) 90 days from the date the repaired or replacement Product is shipped to you or (b) the time remaining on the original one-year warranty; whichever is longer.

What is not covered by this limited warranty ?

This limited warranty does not cover

1. Product that has been subjected to misuse, accident, shipping or other physical damage, improper installation, abnormal operation or handling, neglect, inundation, fire, water or other liquid intrusion; or
2. Product that has been damaged due to repair, alteration or modification by anyone other than an authorized service representative of VTECH; or
3. Product to the extent that the problem experienced is caused by signal





Warranty Statement

- conditions, network reliability or cable or antenna systems; or
4. Product to the extent that the problem is caused by use with non-VTECH electrical accessories; or
 5. Product whose warranty/quality stickers, Product serial numbers plates or electronic serial numbers have been removed, altered or rendered illegible; or
 6. Product purchased, used, serviced, or shipped for repair from outside the United States, or used for commercial or institutional purposes (including but not limited to Products used for rental purposes); or
 7. Product returned without valid proof of purchase (see 2 below); or
 8. Charges for installation or set up, adjustment of customer controls, and installation or repair of systems outside the unit.

How do you get warranty service?

- To obtain warranty service in the United States of America, call 1 800-595-9511 for instructions regarding where to return the Product. Before calling for service, please check the user's manual. A check of the Product controls and features may save you a service call.
- Except as provided by applicable law, you assume the risk of loss or damage during transit and transportation and are responsible for delivery or handling charges incurred in the transport of Product(s) to the service location. VTECH will return repaired or replaced product under this limited warranty to you, transportation, delivery or handling charges prepaid. VTECH assumes no risk for damage or loss of the Product in transit.
- If the Product failure is not covered by this limited warranty, or proof of purchase does not meet the terms of this limited warranty, VTECH will notify you and will request that you authorize the cost of repair prior to any further repair activity. You must pay for the cost of repair and return shipping costs for the repair of Products that are not covered by this limited warranty.

What must you return with the Product to get warranty service?

1. Return the entire original package and contents including the Product to the VTECH service location along with a description of the malfunction or difficulty;
2. Include "valid proof of purchase" (sales receipt) identifying the Product purchased (Product model) and the date of purchase or receipt; and
3. Provide your name, complete and correct mailing address, and telephone number.





Warranty Statement

Other Limitations

- This warranty is the complete and exclusive agreement between you and VTECH. It supersedes all other written or oral communications related to this Product. VTECH provides no other warranties for this product. The warranty exclusively describes all of VTECH's responsibilities regarding the product. There are no other express warranties. No one is authorized to make modifications to this limited warranty and you should not rely on any such modification.

State Law Rights: This warranty gives you specific legal rights, and you may also have other rights which vary from state to state.

Limitations: Implied warranties, including those of fitness for a particular purpose and merchantability (an unwritten warranty that the product is fit for ordinary use) are limited to one year from date of purchase. Some states do not allow limitations on how long an implied warranty lasts, so the above limitation may not apply to you.

- In no event shall VTECH be liable for any indirect, special, incidental, consequential, or similar damages (including, but not limited to lost profits or revenue, inability to use the product, or other associated equipment, the cost of substitute equipment, and claims by third parties) resulting from the use of this product. Some states do not allow the exclusion or limitation of incidental or consequential damages, so the above limitation or exclusion may not apply to you.





FCC, ACTA and IC Regulations

This equipment complies with Parts 15 of the Federal Communications Commission (FCC) rules for the United States. It also complies with regulations RSS210 and CS-03 of Industry and Science Canada. Operation is subject to the following two conditions: (1) this device may not cause interference, and (2) this device must accept any interference, including interference that may cause undesired operation of the device.

A label is located on the underside of the Base Unit containing either the FCC registration number and Ringer Equivalence Number (REN) or the IC registration number and Load Number. You must, upon request, provide this information to your local telephone company.

This equipment is compatible with inductively coupled hearing aids.

Should you experience trouble with this telephone equipment, please contact:

VTech Communications Inc.

CUSTOMER SERVICE at 1-800-595-9511. In Canada, call VTECH Electronics at 1-800-267-7377.



For repair/warranty information. The telephone company may ask you to disconnect this equipment from the line network until the problem has been corrected.



FCC Part 15

Warning: Changes or modifications to this unit not expressly approved by the party responsible for compliance could void the user's authority to operate the equipment.

The equipment has been tested and found to comply with part 15 of the FCC rules. These limits are designed to provide reasonable protection against harmful interference in a residential installation. This equipment generates, uses and can radiate radio frequency energy and, if not installed and used in accordance with the instructions, may cause harmful interference to radio communications. However, there is no guarantee that interference will not occur in a particular installation. If this equipment does cause harmful interference to radio or television reception, which can be determined by turning the equipment off and on, the user is encouraged to try and correct the interference by one or more of the following measures:

- Reorient or relocate the receiving antenna.
- Increase the separation between the equipment and receiver.
- Connect the equipment into an outlet or on a circuit different from that to which the receiver is connected.
- Consult the dealer or an experienced radio/TV technician for help.

35





FCC, ACTA and IC Regulations

FCC and ACTA Information

If this equipment was approved for connection to the telephone network prior to July 23, 2001, it complies with Part 68 of the Federal Communications Commission (FCC) rules. If the equipment was approved after that date, it complies with the Part 68 rules and with Technical Requirements for Connection of Equipment to the Telephone Network adopted by the Administrative Council for Terminal Attachments (ACTA). We are required to provide you with the following information.

1. Product identifier and REN information

The label on the back or bottom of this equipment contains, among other things, an identifier indicating product approval and the Ringer Equivalence Number (REN). This information must be provided to your local telephone company upon request. For equipment approved prior to July 23, 2001, the product identifier is preceded by the phrase "FCC Reg No." and the REN is listed separately. For equipment approved after that date, the product identifier is preceded by "US" and a colon (:), and the REN is encoded in the product identifier without a decimal point as the sixth and seventh characters following the colon. For example, the product identifier US:AAAEQ03T123XYZ would indicate an REN of 0.3.

The REN is used to determine how many devices you may connect to your telephone line and still have them ring when you are called. In most, but not all areas, the sum of all RENs should be five (5.0) or less. You may want to contact your local telephone company for more information.

2. Connection and use with the nationwide telephone network

The plug and jack used to connect this equipment to the premises wiring and the telephone network must comply with the applicable Part 68 rules and technical requirements adopted by ACTA. A compliant telephone cord and modular plug is provided with this product. It is designed to be connected to a compatible modular jack that is also compliant. An RJ11 jack should normally be used for connecting to a single line and an RJ14 jack for two lines. See Installation Instructions in the user's manual. This equipment may not be used with Coin Telephone Lines or with Party Lines. If you have specially wired alarm dialing equipment connected to your telephone line, ensure the connection of this equipment does not disable your alarm equipment. If you have questions about what will disable alarm equipment, consult your telephone company or a qualified installer.

3. Repair instructions

If this equipment is malfunctioning, it must be unplugged from the modular jack until the problem has been corrected. Repairs to this telephone equipment can only be made by the manufacturer or its authorized agents. For repair procedures, follow the instructions outlined under the Limited Warranty.





FCC, ACTA and IC Regulations

4. Rights of the telephone company

If this equipment is causing harm to the telephone network, the telephone company may temporarily discontinue your telephone service. The telephone company is required to notify you before interrupting service. If advance notice is not practical, you will be notified as soon as possible. You will be given opportunity to correct the problem and the telephone company is required to inform you of your right to file a complaint with the FCC. Your telephone company may make changes in its facilities, equipment, operation, or procedures that could affect the proper functioning of this product. The telephone company is required to notify you if such changes are planned.

5. Hearing aid compatibility

If this product is equipped with a corded or cordless handset, it is hearing aid compatible.

6. Programming/testing of emergency numbers

If this product has memory dialing locations, you may choose to store police, fire department and emergency medical service telephone numbers in these locations. If you do, please keep three things in mind:

- a. We recommend that you also write the telephone number on the directory card, so that you can still dial the emergency number manually if the memory dialing feature doesn't work.
- b. This feature is provided only as a convenience, and the manufacturer assumes no responsibility for customer reliance upon the memory feature.
- c. Testing the emergency telephone numbers you have stored is not recommended.

However, if you do make a call to an emergency number:

- You must remain on the line and briefly explain the reason for the call before hanging up.
- Programming/testing of emergency numbers should be performed during off-peak hours, such as in the early morning or late evening, when the emergency services tend to be less busy.

IC (Industry Canada)

This telephone is registered for use in Canada.

The term "IC: " before the certification/registration number only signifies that the Industry Canada technical specifications were met.

NOTICE: This equipment meets the applicable Industry Canada Terminal Equipment Technical Specifications. This is confirmed by the registration number. The abbreviation, IC, before the registration number signifies that registration was performed based on a Declaration of Conformity indicating that Industry Canada technical specifications were met. It does not imply that Industry Canada approved the equipment.





FCC, ACTA and IC Regulations

NOTICE: The Ringer Equivalence Number (REN) for this terminal equipment is 0.7. The REN assigned to each terminal equipment provides an indication of the maximum number of terminals allowed to be connected to a telephone interface. The termination on an interface may consist of any combination of devices subject only to the requirement that the sum of the Ringer Equivalence Numbers of all the devices does not exceed five.

Before installing this equipment, users should ensure that it is permissible to be connected to the facilities of the local telecommunications company. The equipment must also be installed using an acceptable method of connection. The customer should be aware that compliance with the above conditions may not prevent degradation of services in some situations. Repairs to certified equipment should be made by an authorized Canadian maintenance facility designated by the supplier. Any repairs or alterations made by the user to this equipment, or equipment malfunctions, may give the telecommunications company cause to request the user to disconnect the equipment.

Users should ensure for their own protection that the electrical ground connections of the power utility, telephone lines and internal metallic water pipe system, if present, are connected together. This precaution may be particularly important in rural areas.

Caution :

Users should not attempt to make such connections themselves, but should contact the appropriate electrical inspection authority, or electrician, as appropriate.

Your **Cordless Phone** is designed to operate at the maximum power allowed by the FCC and IC. This means your Handset and Base Unit can communicate only over a certain distance - which will depend on the location of the Base Unit and Handset, weather, and the construction and layout of your home or office.



The RBRC® Seal



The **RBRC®** Seal on the nickel-cadmium battery indicates that VTech communications, Inc. is voluntarily participating in an industry program to collect and recycle these batteries at the end of their useful lives, when taken out of service within the United States and Canada.

The **RBRC®** program provides a convenient alternative to placing used nickel-cadmium batteries into the trash or municipal waste, which may be illegal in your area.

VTech's participation in **RBRC®** makes it easy for you to drop off the spent battery at local retailers participating in the **RBRC®** program or at authorized VTech product service centers. Please call **1-800-8-BATTERY™** for information on Ni-Cd battery recycling and disposal bans/restrictions in your area. VTech's involvement in this program is part of its commitment to protecting our environment and conserving natural resources.

RBRC® is a registered trademark of Rechargeable Battery Recycling Corporation.

Additional Information



Technical Specifications

FREQUENCY CONTROL

Crystal controlled
PLL synthesizer

TRANSMIT FREQUENCY

Base: 2411.15 - 2418.4 MHz
Handset: 912.75 - 917.10 MHz

RECEIVE FREQUENCY

Base: 912.75 - 917.10 MHz
Handset: 2411.15 - 2418.4 MHz

CHANNELS

30 Channels

NOMINAL EFFECTIVE RANGE

Maximum power allowed by FCC and IC. Actual operating range may vary according to environmental conditions at the time of use.

SIZE

Handset: 194.0mmx57.8mmx38.0mm
(including antenna)
Base: 225.0mmx212.0mmx80.0mm
(including antenna)

WEIGHT

Handset : 151 grams
Base : 893 grams
(excluding battery pack)

POWER REQUIREMENTS

Handset: 3.6V 400mAh Ni-Cd
Battery Pack

Base : 9V DC @ 400mA

MEMORY

Directory: 50 Memory locations

CID: Alpha Numeric Display
90 Memory locations

**SPECIFICATIONS ARE TYPICAL AND
MAY CHANGE WITHOUT NOTICE.**



vtech

VTECHTELECOMMUNICATIONSLTD.
A member of THE VTECH GROUP OF COMPANIES.

Distributed in the U.S.A. by VTech Communications Inc.; Beaverton, Oregon.

Distributed in Canada by VTech Electronics Canada Ltd., Suite 200, 7671 Alderbridge Way, Richmond, B.C. V6X 1Z9.

Copyright 2002 for VTECHTELECOMMUNICATIONSLTD.
Printed in China

91-5327-10-00
ISSUE 0





CONTENTS

Important Safety Instructions.....	1
Parts Check List.....	2
The Base Unit Layout.....	3
The Cordless Handset Layout.....	4
Getting Started.....	5
Setup.....	5
Connecting Power to Base Unit/Handset Charger.....	5
Installation of Battery Pack in Handset.....	6
Connecting to Phone Line.....	7
Checking for Dial Tone.....	7
Tone/Pulse Selection.....	7
Wall Mounting.....	8
Base Unit.....	8
Handset Charger.....	10
Base Features.....	11
Cordless Handset Features.....	13
Basic Operation.....	15
Operating Instructions.....	15
Cordless Handset Menu.....	15
Setting Date and Time.....	15
Clearing MESSAGES WAITING Alert	15
Base Menu.....	16
Setting Dial Mode.....	16
Clearing MESSAGES WAITING Alert.....	16
What is MESSAGE WAITING alert	16
Making a Call from the Base Unit.....	17
Making a Call from the Cordless Handset.....	17
Answering a Call from the Base Unit	17
Answering a Call from the Cordless Handset.....	17
Ending a Base Unit Call.....	18
Ending a call when using the Cordless Handset.....	18
Intercom.....	19
From Cordless Handset to Base.....	19
From Base to Cordless Handset.....	19
Transferring a Call from Cordless Handset to Base using INTERCOM.....	19
Transferring a Call from Speakerphone or Corded Handset to Cordless Handset.....	19
Handset Ringer Style.....	20
Temporary Tone Dialing (Base or Cordless Handset).....	20
Base Display Messages.....	21
Cordless Handset Display Messages.....	21



CONTENTS

Phone Book Directory.....	22
Storing a Number/Name in the Phone Book Directory.....	22
Edit a Number/Name Stored in the Directory.....	23
Deleting a Number/Name Stored in the Directory.....	24
Caller ID Operation.....	25
About Call History.....	25
Review Call History.....	25
Deleting Records from Call History.....	26
Dial a Displayed Number.....	26
Store a Call History Record in the Phone Book Directory.....	27
Display Screen Messages.....	27
Additional Information.....	28
Headset Operation.....	28
Maintenance.....	29
In Case of Difficulty.....	30
Warranty Statement.....	32
FCC, ACTA and IC Regulations.....	35
The RBRC® Seal.....	39
Technical Specifications.....	40

