



Important Safety Instructions

When using your telephone equipment, basic safety precautions should always be followed to reduce the risk of fire, electric shock and injury, including the following:

1. Read and understand all instructions.
2. Follow all warnings and instructions marked on the product.
3. Unplug this product from the wall outlet before cleaning. Do not use liquid cleaners or aerosol cleaners. Use a damp cloth for cleaning.
4. Do not use this product near water (for example, near a bath tub, kitchen sink, or swimming pool).
5. Do not place this product on an unstable cart, stand, or table. The product may fall, causing serious damage to the product.
6. Slots and openings in the cabinet and the back or bottom are provided for ventilation. To protect it from overheating, these openings must not be blocked by placing the product on the bed, sofa, rug, or other similar surface. This product should never be placed near or over a radiator or heat register. This product should not be placed in a built-in installation where proper ventilation is not provided.
7. This product should be operated only from the type of power source indicated on the marking label. If you are not sure of the type of power supply to your home, consult your dealer or local power company.
8. Do not allow anything to rest on the power cord. Do not locate this product where the cord will be abused by persons walking on it.
9. Never push objects of any kind into this product through cabinet slots as they may touch dangerous voltage points or short out parts that could result in a risk of fire or electric shock. Never spill liquid of any kind on the product.
10. To reduce the risk of electric shock, do not disassemble this product, but take it to an authorized service facility. Opening or removing cabinet parts other than specified access doors may expose you to dangerous voltages or other risks. Incorrect reassembly can cause electric shock when the appliance is subsequently used.
11. Do not overload wall outlets and extension cords as this can result in the risk of fire or electric shock.

-
12. Unplug this product from the wall outlet and refer servicing to an authorized service facility under the following conditions:
 - A. When the power supply cord or plug is damaged or frayed.
 - B. If liquid has been spilled into the product.
 - C. If the product has been exposed to rain or water.
 - D. If the product does not operate normally by following the operating instructions. Adjust only those controls that are covered by the operating instructions, because improper adjustment of other controls may result in damage and will often require extensive work by an authorized technician to restore the product to normal operation.
 - E. If the product has been dropped and the cabinet has been damaged.
 - F. If the product exhibits a distinct change in performance.

 13. Avoid using a telephone (other than a cordless type) during an electrical storm. There may be a remote risk of electric shock from lighting.

 14. Do not use the telephone to report a gas leak in the vicinity of the leak.

CAUTION: TO REDUCE THE RISK OF FIRE OR INJURY TO PERSONS BY BATTERY, READ AND FOLLOW THESE INSTRUCTIONS.

1. Use only the appropriate type and size battery pack specified in the instruction manual provided for this product.
2. Do not dispose of the battery pack in a fire. The cell may explode. Check with State and local codes for possible special disposal instructions.
3. Do not open or mutilate the battery pack. Released electrolyte is corrosive and may cause damage to the eyes or skin. It may be toxic if swallowed.
4. Exercise care in handling battery in order not to short the battery with conducting materials such as rings, bracelets, and keys. The battery or conductor may overheat and cause burns.
5. Charge the battery pack provided with or identified for use with this product only in accordance with the instructions and limitations specified in the instruction manual.
6. Observe proper polarity orientation between the battery pack and battery charger.



Introduction

The **2425** is an advanced cordless telephone that operates in the 2.4GHz frequency range. Your **2425** is capable of supporting up to a maximum of 4 Handsets. Using additional Handsets, two extensions can be conferenced on a call (2 Handsets and the Base Speakerphone), or two extensions can be conferenced on a call, while two other extensions can be talking internally, using the Intercom feature.

This manual is designed to familiarize you with the **2425** cordless telephone. We strongly recommend you read the manual before using your phone.

Parts Check List

1. Handset
2. Base Unit
3. AC Power Adapter
4. Telephone Line Cord
5. Belt Clip
6. Battery Pack
7. Wall Mounting Bracket
8. Owner's Manual



Handset

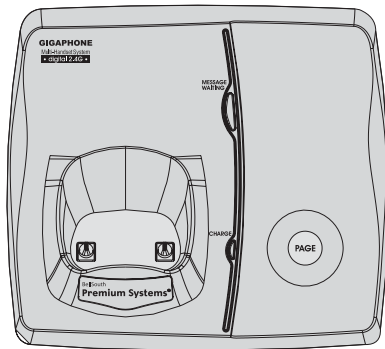

Base Unit

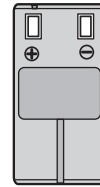

Battery Packs

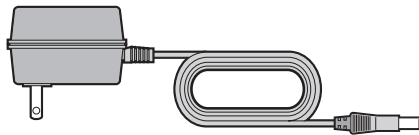

AC Power Adapter

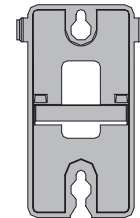

Wall Mounting Bracket



Telephone Line Cord

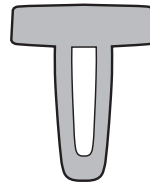

Belt Clip

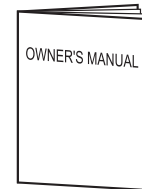

Owner's Manual

The Handset Layout

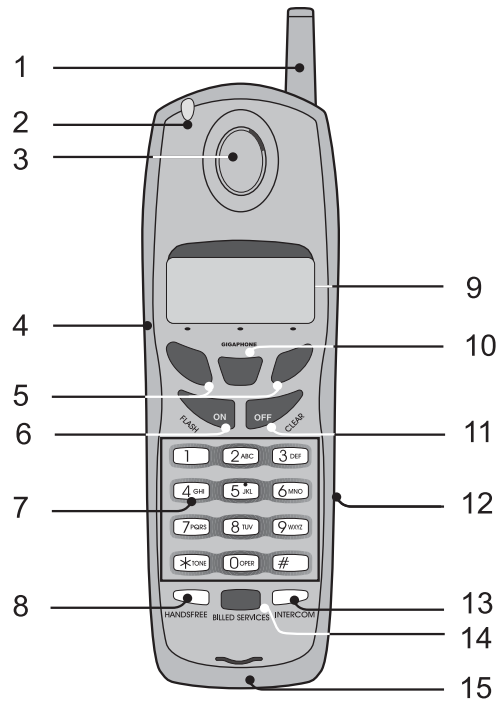

- | | |
|------------------------------|-------------------------|
| 1. Antenna | 9. LCD Display |
| 2. Message Waiting Indicator | 10. Select |
| 3. Earpiece | 11. Off (Clear) |
| 4. Headset Jack (2.5mm) | 12. Battery Compartment |
| 5. Scroll Keys | 13. Intercom |
| 6. On (Flash) | 14. Billed Services |
| 7. Dialing Keys | 15. Microphone |
| 8. Handsfree Speakerphone | |

Setup

1. Plug the AC power adapter into an electrical outlet, and the DC connector into the bottom of the base unit.

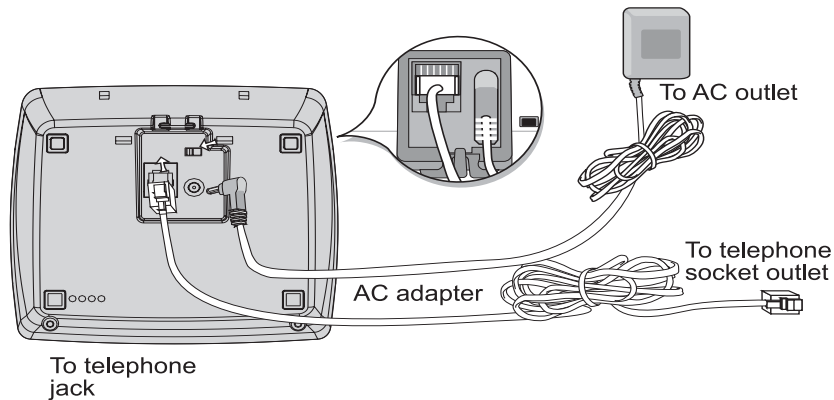

Installation of Battery Pack in Handset

Follow the steps below:

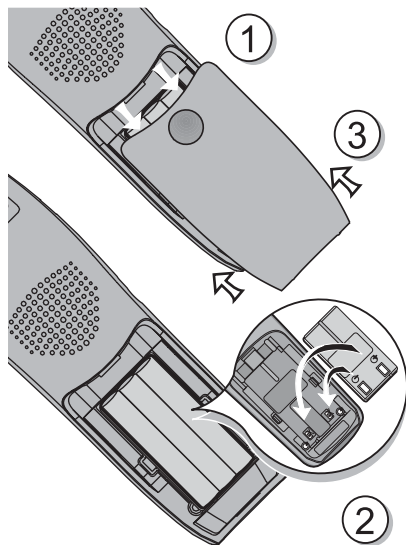

1. Remove the battery cover by pressing on the indent and sliding downward.
2. Place the new battery pack in the handset with the metal contacts aligned with the charge contacts in the battery compartment.
3. Replace the battery cover by sliding it upwards.
4. If the new battery pack is not already charged, place the handset in the base unit, or a remote charging stand, and allow it to charge for 12 hours. After initial charge, a maintenance charge of 8 hours should be sufficient.

Charging Of Handset Battery Pack

The Handset of your **2425** cordless telephone is powered by a rechargeable battery pack. It charges automatically whenever the Handset is in the Base Unit.

You should charge the battery pack for 12 hours when you first receive your phone. You'll know the battery pack needs charging when:

- The low battery message is displayed :
- The handset seems completely dead, the LCD is completely clear and does not activate when you press the keys.

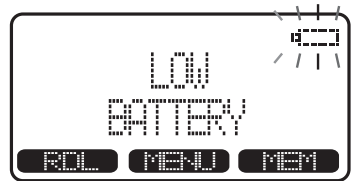

IMPORTANT:

1. Do not dispose of a battery pack in a fire, the cell may explode.
2. Do not open or mutilate the battery pack. Toxic substances may be released, causing harm to eyes or skin.
3. Exercise care in handling battery packs in order to prevent an accidental short of the charge contacts, potentially causing the battery pack to overheat.
4. Do not dispose of this battery pack into household garbage. Please contact your local, state or municipal recycling organization for information on how to properly dispose of your rechargeable battery pack.

Connecting to phone line

Plug one end of the telephone line cord into the jack on the bottom of the base unit. Plug the other end of this cord into the wall jack.

Checking for dial tone

After the battery is charged press **ON** on the Handset. The Phone icon  will appear on the handset display, and you will hear dial tone. If not, see In Case of Difficulty.

Tone/Pulse selection

The **TONE/PULSE** switch is located on the bottom of the Base Unit, near the telephone jack. It is factory set to **TONE**. If you have rotary (Pulse) service, set the switch to **PULSE**.



CAUTION: Use only the power supply provided with your **2425**.

IMPORTANT:

For best performance the **2425** should be installed as follows:

In an elevated location, in the center of the room, with no obstructions nearby.

In a location that is away from other electrical appliances such as microwave ovens, personal computers, or televisions.

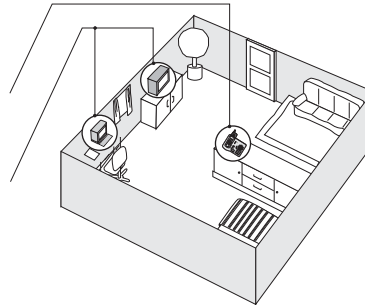

Wall Mounting

The Wall Mount bracket is designed for use on standard Wall Mount plates only.

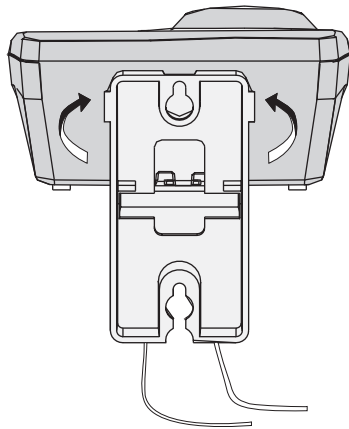

1. Line up the tabs on the wall mount adapter with the holes on the bottom of the Base Unit. Snap the wall mount bracket firmly in place.
2. Plug the AC adapter into an electrical outlet, and the DC connector to the bottom of the Base Unit. If the handset battery pack has not been charged previously, place the handset in the base unit cradle, and allow it to charge for 12 hours.
3. Connect the telephone line cord to the jack on the bottom of the Base Unit, and the other end to the wall jack.
4. Mount the base unit on the wall. Position the base unit so the mounting studs will fit into the holes on the wall mount bracket. Slide base unit down on the mounting studs until it locks into place.

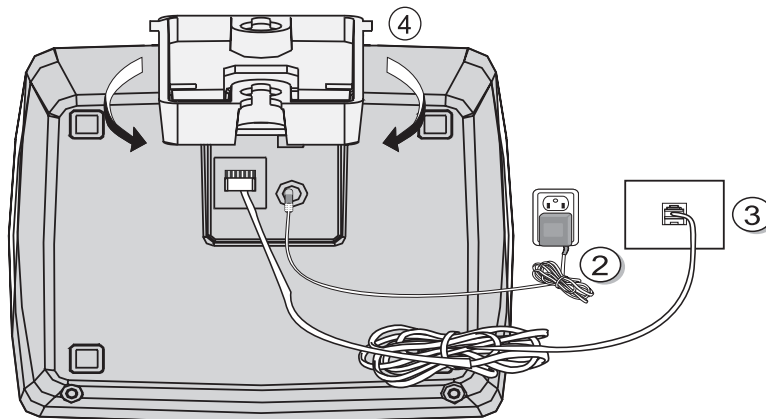

Registration and Operation

Registration And Operation Of The 2425 Accessory Handset

Your **2425** system can operate up to 4 Handsets.

The accessory Handset, model **2422**, consists of the following:

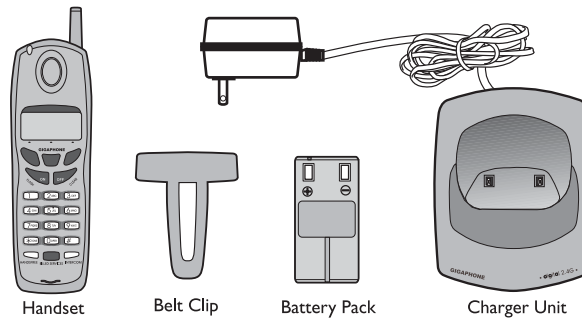

The original Handset that is shipped with your **2425** system will be automatically registered to the Base. This Handset is **HANDSET 1**.

As you register additional Handsets to the system, they will be assigned extension numbers in the following order: **HANDSET 2**, **HANDSET 3**, and finally **HANDSET 4**.

Whenever a Handset battery pack is installed, the Handset will automatically begin **SEARCHING FOR BASE** (if previously registered), or it will prompt you to **ENTER BASE ID** to register the new Handset.

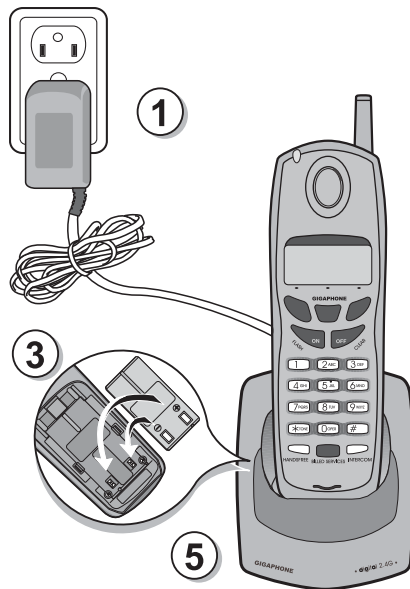

Setup Of The 2422 Accessory Handset

1. Plug the AC power adapter into an electrical outlet.
2. Remove the Handset battery cover by pressing on the indent and sliding downward.
3. Place the new battery pack in the Handset, with the metal contacts aligned with the charge contacts in the battery compartment.
4. Replace the battery cover by sliding it upward.
5. Place the Handset in the Charge Cradle, and allow it to charge for 12 hours. After the initial charge, a maintenance charge of 8 hours should be sufficient.

Registration and Operation

Enter Base ID Code

1. After charging the Handset, remove it from its Charge Cradle, the screen will display:



2. Press **NEW**, then enter the 15 digit Base Unit ID code, located on the underside of the Base Unit.

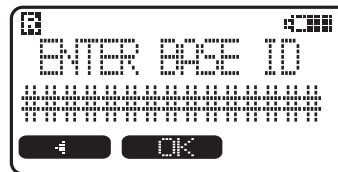

3. Press **OK**. The Handset will display: **PLEASE WAIT!!**

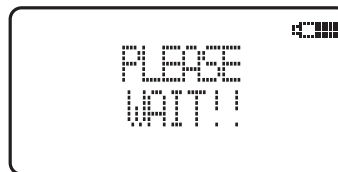

4. Wait approximately 15 seconds. The Handset will display: **FOUNDBASE**

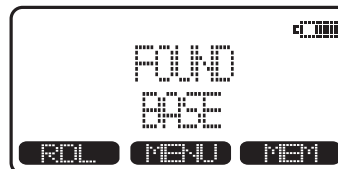

If the Handset displays: **BASE BUSY TRY LATER**, this indicates that the system is in use. Wait until the Base Unit is in the idle (on hook) mode, and repeat step 2 to 4.



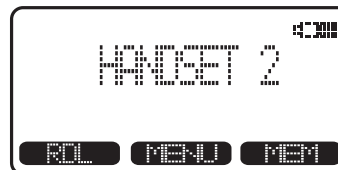



NOTE: Occasionally, it may take longer than 15 seconds for the Handset to confirm registration to the Base Unit. This is normal.



Congratulations! You can now enjoy the benefits of your multi-Handset system.

Handset and Base Indicators

Handset Icons

Icon	Description
	<p><u>Line In Use indicator</u> On steady with no number next to it when a parallel set is in use. On steady with one or more numbers next to it, indicating which extensions are using the line. For example,  12 indicates that Handset 1 and Handset 2 are on an outside call.</p>
	<p><u>Intercom indicator</u> On steady with the extension numbers currently on an intercom call. For example,  02 indicates that the Base and Handset 2 are on an intercom call.</p>
	<p><u>Battery indicator</u> Indicates the charge level of the battery pack Cycles (Low, Medium, and High) when Handset battery is charging. Flashes when a low battery condition is detected.</p>
E	<p><u>Range Extender indicator</u> On steady when an active Handset is in Range Extender mode.</p>
M	<p><u>Mute indicator</u> On steady when the Handset microphone is muted.</p>
H	<p><u>Hold indicator</u> On steady when the line is on hold.</p>
R	<p><u>Handset Registration indicator</u>  is displayed when a Handset is either not registered, or is searching for a Base unit.</p>

Handset and Base Indicators

Handset LEDs

LED	Description
Message Waiting	Flashes to indicate that you have new messages in your voicemail. Service must be subscribed to through your local telephone company.

Base LEDs

LED	Description
Message Waiting	Flashes to indicate that you have new messages in your voicemail. Service must be subscribed to through your local telephone company.
Charge	Lights whenever the handset is placed in the base unit charge cradle.

Soft Menu Functions

The **2425** has an advanced design that uses a menu structure and soft keys to access all of the built-in features.

Example of the idle mode display:

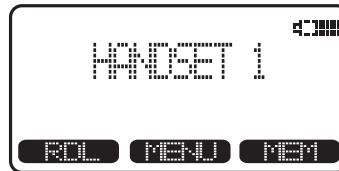

RDL (Redial)

Press **RDL** to display the last 5 telephone numbers dialed. The number on the top line is the most recent number dialed.

- Use the  scroll keys to select the desired the number.
- To dial the number, you can simply press the **ON** or **HANDSFREE** key.
- To erase (or save) the number, select this option to delete (or save) it.

MENU

With the Handset in the idle (OFF) mode, press the **MENU** key to access the following options:

- **CALLS LOG (CALLER ID)**
- **HANDSET SETTINGS**
- **RANGE EXTENDER**
- **REGISTER**

Use the  scroll keys to select the desired option, then press **OK**.

Calls Log (Caller ID)

From the idle (OFF) mode, press **MENU**, use the  scroll keys to select **CALLS LOG**, then press **OK**. The Caller ID information of the most recently received call will be displayed. For example:



To scroll to other records, use the  scroll keys.

To dial the number displayed, you can simply press the **ON** or **HANDSFREE** key.

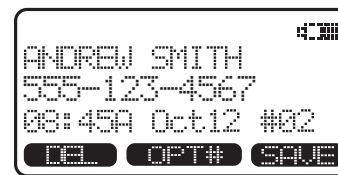

You can also press the **CID** key to access the following options (**DEL**, **OPT#**, **SAVE**):

- DEL** : Select this option to delete THIS or ALL records in Caller ID memory.
- OPT#** : Select this option to display up to four possible dialing strings of the number stored in Caller ID memory. If a number is provided in the Caller ID data, the possible options to choose from will be either 7, 8, 10, or 11 digits. For example, if the original number in Caller ID memory was 800-595-9511, then the display options will be:

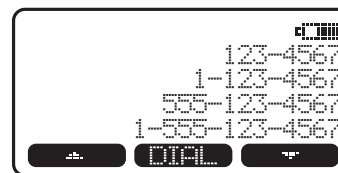

Use the **▲** and **▼** keys to make selection, and then press **DIAL**, **ON** or **HANDSFREE** to dial the number.

- SAVE** Select this option to save the displayed Caller ID record into Speed Dial Memory. Only Caller ID records with telephone numbers can be saved into Speed Dial Memory. If you need to modify the number after saving, see **To Edit a Number/Name**.

Caller ID - Call Waiting ID

Your **2425** is capable of displaying the name and/or number of the party calling before you answer the phone (**Caller ID**). It is also capable of displaying Caller ID information in conjunction with a Call Waiting alert signal (**Call Waiting Caller ID**). With Call Waiting Caller ID, the Caller ID data is displayed so you can decide whether to answer the incoming call, or continue with your current conversation.

NOTES ABOUT CALLER ID & CALL WAITING CALLER ID

These are subscription services, provided by most regional telephone service providers. You must subscribe to these services to get the benefits of these features. If you do not subscribe to Caller ID services, you can still use your SPRINT and the other features it offers.

Due to regional incompatibilities, Caller ID information may not be available for every call you receive. In addition, the calling party may intentionally block their name and phone number from being sent.

Handset Settings

In the idle (**OFF**) mode, press **MENU**, then scroll down to **HANDSET SETTINGS**. Press **OK**. You can now select from the following options:

- **RINGER VOLUME**

Select this option to adjust the ringer volume. Use the  scroll keys to adjust the volume up or down. The Handset will display a graphic indicator of the selected volume setting. Press **OK** to confirm your selection and return to the Handset Settings menu.
- **RINGER MELODY**

Select this option to adjust the ringer melody or tone. Use the  scroll keys to select from the six available tones. Press **SAVE** to confirm your selection and return to the Handset Settings menu.
- **LOW BATT TONE (preset to ON)**

Select this option to turn the Low Battery warning tone **ON** or **OFF**. Press the OFF or ON soft keys, to make your selection. Press **OK** to confirm your selection and return to the Handset Settings menu. When set to **ON**, the Handset will emit a warning tone when a Low Battery condition is detected.
- **RANGE TONE (preset to ON)**

Select this option to turn the Out of Range warning tone **ON** or **OFF**. Press the OFF or ON soft keys, to make your selection. Press **OK** to confirm your selection and return to the Handset Settings menu. When set to **ON**, the Handset will emit a warning tone whenever the Handset is taken out of range of the Base.
- **KEYPAD TONE (preset to ON)**

Select this option to turn the Keypad tones **ON** or **OFF**. Press the OFF or ON soft keys, to make your selection. Press **OK** to confirm your selection and return to the Handset Settings menu. When set to **ON**, the Handset will emit a beep whenever a key is pressed.
- **CONTRAST**

Select this option to adjust the contrast level of the Handset display. Use the  scroll keys to make your selection. The handset display will automatically adjust as you make your selection. Press **OK** to confirm your selection and return to the Handset Settings menu.
- **LANGUAGE (preset to ENGLISH)**

Select this option to adjust English or Spanish display on the LCD.

Range Extender

Your **2425** has an enhanced feature that is designed to improve performance. If you are using your system in an area with excessive interference, or you require a moderate increase in operating range, the Range Extender feature can help to improve both the sound quality and range. Actual range will depend on your environment.

Your **2425** comes preset for **AUTO** Range Extender mode.

To select another Range Extender setting, follow the procedure listed below:

- In the idle(OFF) mode, press MENU and use the scroll keys to select RANGE_EXTENDER, then press OK.
- There are 3 option settings in the RANGE_EXTENDER menu:
 1. Select **OFF** to disable RANGE_EXTENDER
 2. Select **ON** to enable RANGE_EXTENDER. An "E" icon will appear in the upper left corner of the Handset display, indicating that RANGE_EXTENDER is ON.
 3. Select **AUTO** to allow your **2425** to automatically monitor the signal strength between the handset and base unit, and activate whenever necessary. With this option selected, your **2425** system will enable and disable the RANGE_EXTENDER feature as needed. When RANGE_EXTENDER is enabled, an "E" icon will appear in the upper left corner of the Handset display.
- Use the scroll keys to select the desired setting, and then press OK to confirm the selection.

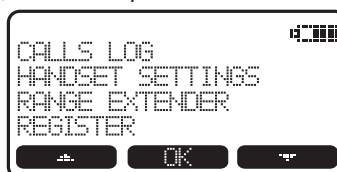

Note : When Range Extender mode is enabled, your **2425** will consume more battery power. That means the standby and talk time of your Handset will be shorter.

Register

Use this option to register a Handset to the **2425** Base. You can register a total of four Handsets. This process is activated automatically whenever a new handset is powered up in range of the Base.

You will be prompted to enter the 15-digit Base ID code printed on the underside of the base unit. After entering this code, press **OK**. The Handset will display **SEARCHING FOR BASE**, and then **FOUND BASE** when the process is complete.

Note : Base ID codes are 15 digits long and can include the following characters : 0, 1, 2, 3, 4, 5, 6, 7, 8, 9, *, or #.

MEM (Memory)

The **2425** can store up to 50 names/numbers in memory. Each memory location can hold up to 32 digits and up to 16 characters for the name.

When prompted to **ENTER NAME**, use the number keys to 'spell' the name. Each press of a particular key causes characters to be displayed in the following order:

Number Key	Characters (in order)
1	& ' , . 1
2	A B C a b c 2
3	D E F d e f 3
4	G H I g h i 4
5	J K L j k l 5
6	M N O m n o 6
7	P Q R S p q r s 7
8	T U V t u v 8
9	W X Y Z w x y z 9
0	0
*	*
#	#

MEM (Memory)

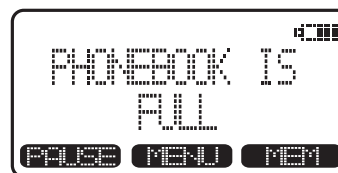
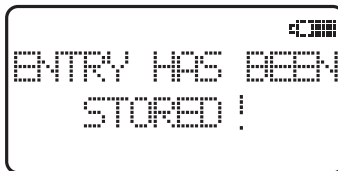
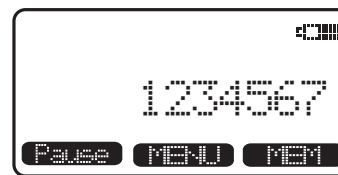
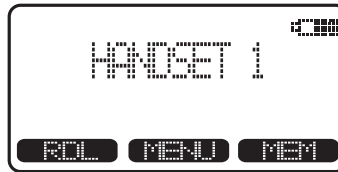

To Store a Number/Name:

- Starting from the idle screen, enter the number you want to store in memory.
- Be sure to include long distance codes and pauses (using the **PAUSE** softkey) if necessary. Press the **MEM** softkey.
- You will then be prompted to **ENTER NAME**. Use the number keys to 'spell' the name. If you make a mistake, press the **CLR** softkey. To enter a space press **▶**. When finished, press **SAVE**.
- If there is space available in memory, the number/name will be saved and the Handset will display.
- If the memory is full the Handset will display **PHONEBOOK IS FULL** and exit to the idle screen without saving the entry.



MEM (Memory)

To Search For and Dial a Number/Name:

- Starting from the idle screen, press the **MEM** softkey to review memory contents.
- Using the  /  softkeys scroll through the memory contents in alphabetical order. Or press one of the number keys to go directly to the closest match for the letter represented by that key. For example, pressing '5' will bring up any entries that start with J,K, or L.
- Or, you can press the **FIND** softkey, enter the first few characters of the name and then press **FIND** to search. If you make a mistake, press **CLR** softkey. The closest match, in alphabetical order, will be displayed.
- Once you find the entry you want, simply press **ON** or **HANDSFREE** to dial the number.

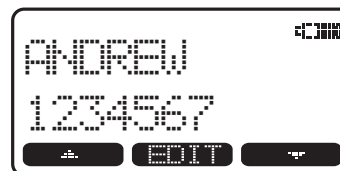
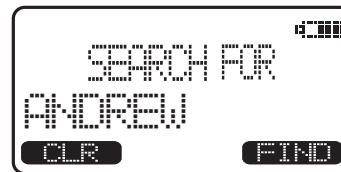
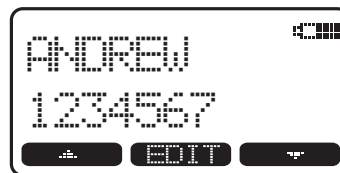

To Delete a Number/Name:

- Using the steps in **To Search For and Dial a Name/Number**, locate the entry you want to delete.
- Press the **EDIT** softkey. The Handset will display:



MEM (Memory)

- Press the **DEL** softkey. The Handset will display:
- To delete this record press **THIS**. To delete all record, press **ALL**.
- To confirm the deletion of **ALL** records, press **YES**. To exit without deleting press **NO**.

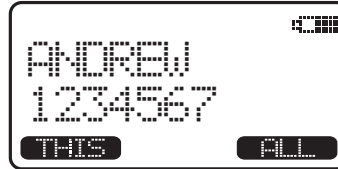

To Edit a Number/Name:

- Use the steps in **To Search for and Dial a Number/Name** to locate the entry you want to edit.
- After you locate the entry, press the **EDIT** softkey twice. The Handset will display :
- Press **NAME** to edit the name.
- Press **▶** softkey move the cursor to the character you want to edit.
- Press **MORE** softkey you will have more editing function.
 - **DEL** : You can delete the characters
 - **BACK** : You can return to the pervious screen.
 - **SPACE** : You can inset space between characters.
- After finish editing the name, press **SAVE**. Then, you can go to edit the number by pressing **NUM** softkey.
- Press **▶** softkey move the cursor to the character you want to edit.
- Press **MORE** softkey you will have more editing function.
 - **DEL** : You can delete digits
 - **BACK** : You can return to the pervious screen
 - **PAUSE** : You can insert a pause.
- After editing the number, press **SAVE**.
- Finally, you can press **OFF** key to exiting the editing mode.



Handset and Base Operation

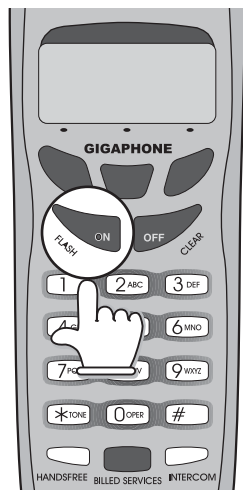

Making Calls

From the Handset



- Press **ON** (or, **HANDSFREE** to use the Handset Speakerphone feature). Dial the phone number.

-OR-

- Dial the phone number first; then press **ON** (or **HANDSFREE**).
- Press **OFF** to end your call.

Answering Calls

From the Handset



- Press any key except **OFF** and the softkeys.
- Press **OFF** to end your call.

Hold Function



- Press the **HOLD** soft key to place a call on hold. To return to the call press the **ON** or **HANDSFREE** key.

Flash Function



- You can use your **GIGAPHONE** with services such as Call Waiting. Simply press the **ON** key on the Handset.

Volume Control

During an active call, press the **VOL** soft key, then use the **Up** and **Down** soft keys to adjust the earpiece or Handsfree Speakerphone volume. Press **OK** to confirm your choice.

Handset and Base Operation

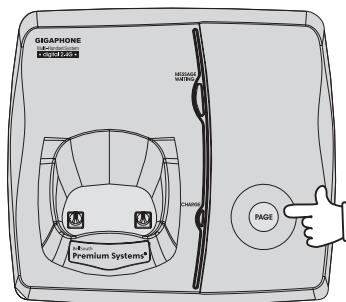

Page/Intercom



From Base to ALL Handsets :

- To page all Handsets from the Base press the **PAGE** key. This will cause all Handsets linked with this Base to ring for approximately 20 seconds.
- Each Handset will display **PAGE FROM BASE**.

From Handset to Handset :

- Press the **INTERCOM** key followed by the number of the other Handset you wish to call (e.g. **INTERCOM 3**).
- Handset 3 can then answer the intercom call by pressing the **INTERCOM** key.
- To end the intercom call press **OFF** on either Handset.

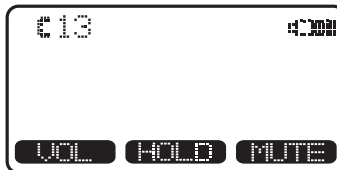

All Call from Handset

- Press the **INTERCOM** key followed by the **★**. All registered Handsets will ring.
- Any Handset can answer by pressing **INTERCOM**.
- To end the intercom call press **OFF** on Handset.

Handset and Base Operation

Handsfree Speakerphone Operation

Your **2425** handset has a built-in handsfree speakerphone. This feature allows you to stand the Handset upright on a table or desktop and have handsfree conversations. For more information, refer to **MAKING CALLS in HANDSET AND BASE OPERATION**.

Line in Use Indication

On the Handset :
When the telephone line is currently being used by a **2425** Handset , a status message similar to this will display on idle Handset(s):

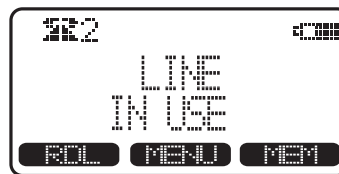

When the telephone line is currently being used by a parallel set (a telephone device other than the **2425** on the same line); the phone icon will remain on steadily, and EXTENSION IN USE will be displayed.

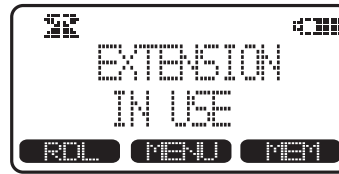

Low Battery Indication

When a low battery is detected, the Battery icon will flash and a warning beep is played. The status message LOW BATTERY will also be displayed when the Handset is in idle mode. To prevent an unexpected call drop, a drained Handset battery should be replaced by a fully charged spare battery.

Handset and Base Operation

Message Waiting Indication

The **2425** is compatible with optional voicemail service provided by some local telephone companies. If you subscribe to this service, and you have new, unplayed messages in your voicemail, a Visual Message Waiting Indicator (VMWI) signal is transmitted by your local telephone company.

The **2425** will detect a VMWI signal and activate a the Message Waiting light on the Base and the Message Waiting light on the Handset.

After you check your messages, the Message Waiting indicators will automatically turn off.

Please note that whenever new, unplayed messages are stored in your voicemail, the local Telephone Company will continue to send a VMWI signal.

Conference Calling

The **2425** is capable of supporting conference calls with up to two registered Handsets.

To enter a conference call, simply access the line with two extensions by pressing **ON** (or HANDSFREE) on the Handset.

The phone icon  and two extension numbers will be displayed in the upper left corner of the Handset.

Transferring Calls

You can transfer calls on the **2425** system from Handset to Handset.

Blind Transfer

You can directly transfer any active call to another **2425** extension without notification by doing the following steps:

- Handset must be on an active call.
- Press the **INTERCOM** key followed by the number of the Handset (**1,2,3,4**) that you wish to transfer the call to.
- When the other extension answers, the call will automatically be connected to the other extension.
- An unanswered call will ring back to the originating Handset if not answered within 30 seconds

Handset and Base Operation

Announced Transfer:

You can perform an announced transfer (call and advise another extension) of an active call by doing the following steps:

- Handset must be on an active call.
- Place the active call on **HOLD**.
- Press the **INTERCOM** key followed by the number of the Handset (**1,2,3,4**) that you wish to transfer the call to.
- When the other extension answers the intercom call, explain they have an active call waiting.
- Either extension press **OFF** to end the intercom call.
- The other extension presses **ON, HANDSFREE**, to pick up the call on hold.

Custom Pay-Per-Use(PPU) Features

AUTOCALLBACK

3-WAY CALLING

REPEATDIALING

To use a custom Pay-Per-Use feature, do the following:

- Press the **BILLED SERVICES** key.
- Using the ▲ / ▼ soft keys, scroll until the desired custom feature is highlighted.
- Press **OK**

AUTO CALL BACK dials the last party who called you, whether or not you answer the call. A charge is added to your phone bill each time you use this feature.

3-WAY CALLING allows you to talk with 2 separate parties from a single line. The set-up procedure is as follows:

- 1) Call your first party ; after the party answer,
- 2) Press **3-WAY CALLING**. Wait for dial tone.
- 3) Call your second party; after the call is answered.
- 4) Press **3-WAY CALLING** again.

A charge is added to your phone bill each time this service is used.

REPEAT DIALING repeatedly dials the last number you called, over a time interval determined by your local phone company. This is useful in reaching a party whose line is busy. A charge is added to your phone bill each time this service is used.

NOTE: It is likely that your local telephone company will assess charges to use custom features. You should check with your local service provider regarding which custom services are available in your area, and the associated costs for the intentional or unintentional use of Pay Per Use services.

Your local telephone company may provide a monthly subscription to an individual service or a package of services which gives you unlimited usage for a small monthly fee.

Headset Operation

Your **2425** cordless telephone is equipped with a 2.5mm Headset Jack for use with an accessory Headset for hands-free operation.

Locate the Headset Jack on the Handset. Connect the plug on the Headset cord to the jack on the cordless Handset. The plug should fit securely. Do not force the connection.

Operation

NOTE:

Whenever a compatible Headset is connected to the cordless Handset, the microphone on the Handset will be muted. This is done to limit the effect of background noise.

Belt Clip

The **2425** is also equipped with a detachable belt clip. Align the pins on the inside edge of the clip with the notches on the sides of the Handset. The belt clip should snap securely into place. Do not force the connection.

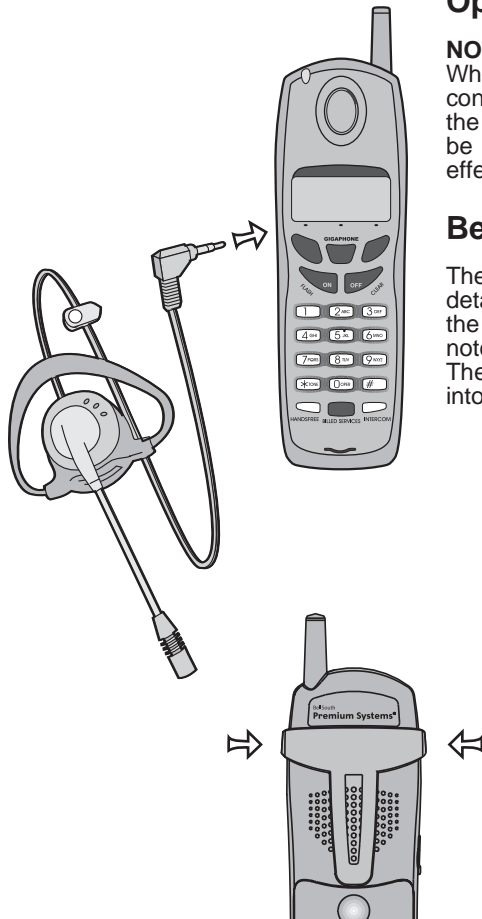

Maintenance

Taking Care Of Your Telephone

Your cordless telephone contains sophisticated electronic parts, so it must be treated with care.

Avoid rough treatment

Place the Handset down gently. Save the original packing materials to protect your telephone if you ever need to ship it.

Avoid water

Your telephone can be damaged if it gets wet. Do not use the Handset outdoors in the rain, or handle it with wet hands. Do not install your Base Unit near a sink, bathtub or shower.

Electrical storms

Electrical storms can sometimes cause power surges harmful to electronic equipment.

For your own safety, use caution when using electric appliances during storms.

Cleaning your telephone

Your telephone has a durable plastic casing that should retain its luster for many years. Clean it only with a soft cloth slightly dampened with water or a mild soap. Do not use excess water or cleaning solvents of any kind.

Remember that electrical appliances can cause serious injury if used when you are wet or standing in water. If your Base Unit should fall into water, **DO NOT RETRIEVE IT UNTIL YOU UNPLUG THE POWER CORD AND TELEPHONE LINE CORDS FROM THE WALL.** Then pull the unit out by the unplugged cords.

In Case Of Difficulty

If you have difficulty operating your phone, the suggestions below should solve the problem. If you still have difficulty after trying these suggestions, call BELLSOUTH at 800-733-2355, or Small Business Products call 800-298-0973.

The Phone Doesn't Work At All

- Make sure the Power Cord is plugged in.
- Make sure the telephone line cord is plugged firmly into the Base Unit and the telephone wall jack.
- Make sure the batteries are properly charged. If the 'LOW BATTERY' message is shown, the battery pack needs charging.

No Dial Tone

- First check all the suggestions above.
- If you still don't hear a dial tone, disconnect the Base Unit from the telephone jack and connect a different phone. If there is no dial tone on that phone either, the problem is in your wiring or local service. Contact your local telephone company.

You Get Noise, Static, Or A Weak Signal Even When You're Near The Base Unit

- Household appliances plugged into the same circuit as the Base Unit can sometimes cause interference. Try moving the appliance or the Base Unit to another outlet.

You Get Noise, Static, Or A Weak Signal When You're Away From The Base Unit

- You may be out of range. Either move closer to the Base, or relocate the Base Unit.
- The layout of your home may be limiting the range. Try moving the Base Unit to another position.

The Handset Does Not Ring When You Receive A Call

- Make sure you have the Handset ringer activated. To set the ringer, see HANDSET SETTINGS and BASE SETTINGS.
- Make sure the telephone line cord is plugged firmly into the Base Unit and the telephone jack. Make sure the power cord is plugged in.
- You may be too far from the Base Unit.
- You may have too many extension phones on your telephone line to allow all of them to ring. Try unplugging some of the other phones.

In Case Of Difficulty

You Hear Other Calls While Using Your Phone

- Disconnect your Base Unit from the telephone jack, and plug in a regular telephone. If you still hear other calls, the problem is probably in your wiring or local service. Call your local telephone company.

You Hear Noise In The Handset, And None Of The Keys Or Buttons Work

- Make sure the power cord is plugged in.

Common Cure For Electronic Equipment

If the unit does not seem to be responding normally, then try putting the Handset in the cradle. If it does not seem to respond, do the following (in the order listed) :

1. Disconnect the power to the Base.
2. Disconnect the Handset battery, and spare battery pack, if applicable.
3. Wait a few minutes.
4. Connect power to the Base.
5. Re-install the battery pack (s)
6. Watch for Handset to display :

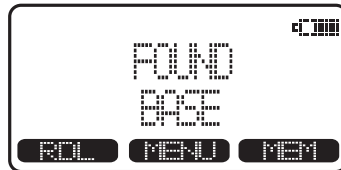
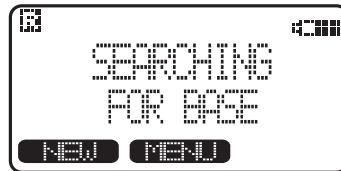

Warranty Statement

WHAT DOES OUR WARRANTY COVER?

- Any defect in material or workmanship.

FOR HOW LONG AFTER THE ORIGINAL PURCHASE?

- To the original purchaser only - ONE YEAR.

WHAT WILL BellSouth DO?

- At our option, repair or replace your unit.

HOW DO I SEND MY UNIT, IN OR OUT OF WARRANTY?

- In the U.S. Call BELLSOUTH at: 800-733-2355, or Small Business Products call 800-298-0973.
- Properly pack your unit. Include any cables & accessories which were originally provided with the product. We recommend using the original carton and packing materials.
- Include in the package a copy of the sales receipt or other evidence of date of original purchase (if the unit was purchased within the last twelve months).
- Print your name and address, along with a description of the defect, and include this in the package.
- Include payment for any service or repair not covered by warranty, as determined by BellSouth.

WHAT DOES OUR WARRANTY NOT COVER?

- Batteries
- Damage from misuse, neglect, or acts of nature (lightning, floods, power surges, etc.)
- Products which may have been modified or incorporated into other products
- Products purchased and/or operated outside the USA, its territories, or Canada.
- Products serviced by the owner or a service facility not expressly authorized by BellSouth.
- Products purchased more than 12 months from current date
- Units purchased in "AS IS" condition, or units purchased as "Distressed Merchandise".

HOW DOES STATE LAW OR PROVINCIAL LAW RELATE TO THIS WARRANTY?

- This warranty gives you specific rights. You may also have other rights which vary from state to state or province to province.

FCC, ACTA Regulations

This equipment complies with Parts 15 of the Federal Communications Commission (FCC) rules for the United States. It also complies with regulations RSS210 and CS-03 of Industry and Science Canada. Operation is subject to the following two conditions: (1) this device may not cause interference, and (2) this device must accept any interference, including interference that may cause undesired operation of the device.

A label is located on the underside of the Base Unit containing either the FCC registration number and Ringer Equivalence Number (REN) or the IC registration number and Load Number. You must, upon request, provide this information to your local telephone company.

This equipment is compatible with inductively coupled hearing aids.

Should you experience trouble with this telephone equipment, please contact:

BELLSOUTH
Service Dept. at: 800-733-2355, or Small Business Products call 800-298 0973.

For repair/warranty information. The telephone company may ask you to disconnect this equipment from the line network until the problem has been corrected.

FCC Part 15

Warning: Changes or modifications to this unit not expressly approved by the party responsible for compliance could void the user's authority to operate the equipment.

The equipment has been tested and found to comply with part 15 of the FCC rules. These limits are designed to provide reasonable protection against harmful interference in a residential installation. This equipment generates, uses and can radiate radio frequency energy and, if not installed and used in accordance with the instructions, may cause harmful interference to radio communications. However, there is no guarantee that interference will not occur in a particular installation. If this equipment does cause harmful interference to radio or television reception, which can be determined by turning the equipment off and on, the user is encouraged to try and correct the interference by one or more of the following measures:

- Reorient or relocate the receiving antenna.
- Increase the separation between the equipment and receiver.
- Connect the equipment into an outlet or on a circuit different from that to which the receiver is connected.
- Consult the dealer or an experienced radio/TV technician for help.

FCC and ACTA Information

If this equipment was approved for connection to the telephone network prior to July 23, 2001, it complies with Part 68 of the Federal Communications Commission (FCC) rules. If the equipment was approved after that date, it complies with the Part 68 rules and with Technical Requirements for Connection of Equipment to the Telephone Network adopted by the

FCC, ACTA Regulations

Administrative Council for Terminal Attachments (ACTA). We are required to provide you with the following information.

1. Product identifier and REN information

The label on the back or bottom of this equipment contains, among other things, an identifier indicating product approval and the Ringer Equivalence Number (REN). This information must be provided to your local telephone company upon request. For equipment approved prior to July 23, 2001, the product identifier is preceded by the phrase "FCC Reg No." and the REN is listed separately. For equipment approved after that date, the product identifier is preceded by "US" and a colon (:), and the REN is encoded in the product identifier without a decimal point as the sixth and seventh characters following the colon. For example, the product identifier US:AAAEQ03T123XYZ would indicate an REN of 0.3.

The REN is used to determine how many devices you may connect to your telephone line and still have them ring when you are called. In most, but not all areas, the sum of all RENs should be five (5.0) or less. You may want to contact your local telephone company for more information.

2. Connection and use with the nationwide telephone network

The plug and jack used to connect this equipment to the premises wiring and the telephone network must comply with the applicable Part 68 rules and technical requirements adopted by ACTA. A compliant telephone cord and modular plug is provided with this product. It is designed to be connected to a compatible modular jack that is also compliant. An RJ11 jack should normally be used for connecting to a single line and an RJ14 jack for two lines. See Installation Instructions in the user's manual. This equipment may not be used with Coin Telephone Lines or with Party Lines. If you have specially wired alarm dialing equipment connected to your telephone line, ensure the connection of this equipment does not disable your alarm equipment. If you have questions about what will disable alarm equipment, consult your telephone company or a qualified installer.

3. Repair instructions

If this equipment is malfunctioning, it must be unplugged from the modular jack until the problem has been corrected. Repairs to this telephone equipment can only be made by the manufacturer or its authorized agents. For repair procedures, follow the instructions outlined under the Limited Warranty.

4. Rights of the telephone company

If this equipment is causing harm to the telephone network, the telephone company may temporarily discontinue your telephone service. The telephone company is required to notify you before interrupting service. If advance notice is not practical, you will be notified as soon as possible. You will be given the opportunity to correct the problem and the telephone company is required to inform you of your right to file a complaint with the FCC. Your telephone company may make changes in its facilities, equipment, operation, or procedures that could affect the proper functioning of this product. The telephone company is required to notify you if such changes are planned.

FCC, ACTA Regulations

5. Hearing aid compatibility

If this product is equipped with a corded or cordless handset, it is hearing aid compatible.

6. Programming/testing of emergency numbers

If this product has memory dialing locations, you may choose to store police, fire department and emergency medical service telephone numbers in these locations. If you do, please keep three things in mind:

- a. We recommend that you also write the telephone number on the directory card, so that you can still dial the emergency number manually if the memory dialing feature doesn't work.
- b. This feature is provided only as a convenience, and the manufacturer assumes no responsibility for customer reliance upon the memory feature.
- c. Testing the emergency telephone numbers you have stored is not recommended.

However, if you do make a call to an emergency number:

- You must remain on the line and briefly explain the reason for the call before hanging up.
- Programming/testing of emergency numbers should be performed during off-peak hours, such as in the early morning or late evening, when the emergency services tend to be less busy.

Technical Specifications

FREQUENCY CONTROL

Crystal controlled
PLL synthesizer

TRANSMIT FREQUENCY

2401.056 - 2481.408 MHz

RECEIVE FREQUENCY

2401.056 - 2481.408 MHz

CHANNELS

94 Channels

NOMINAL EFFECTIVE RANGE

Maximum power allowed by FCC.
Actual operating range may vary
according to environmental
conditions at the time of use.

SIZE

Handset : 48mmx33mmx175mm

Base : 136mmx74mmx123mm

WEIGHT

Handset: 173grams
Base : 208grams

POWER REQUIREMENTS

Handset: 800mAh NiCd Battery
Pack or 1500mAh NiMH
Battery Pack

Base : 7 VDC @ 500mA

MEMORY

Speed Dial: 50 Memory locations;
32 digits per location.

CID : Alpha Numeric Display
50 Memory locations

**SPECIFICATIONS ARE TYPICAL
AND MAY CHANGE WITHOUT
NOTICE.**



Table Of Contents

- | | | |
|--|---------------|-----------------------------------|
| 1. Important Instructions | Safety | 29. Additional Information |
| | | 29. Maintenance |
| | | 30. In Case Of Difficulty |
| 3. Introduction | | 32. Warranty Statement |
| 4. Parts Check List | | 33. FCC, ACTA Regulations |
| 5. The Handset Layout | | 36. Technical Specifications |
|
 | | |
| 6. Getting Started | | |
| 6. Setup | | |
| 9. Wall Mounting | | |
| 10. Registration and Operation | | |
|
 | | |
| 12. Basic Operation | | |
| 12. Handset and Base Indicators | | |
| 14. Soft Menu Functions | | |
| 14. RDL (Redial) | | |
| 14. MENU | | |
| 15. Calls Log (Caller ID) | | |
| 16. Handset Settings | | |
| 17. Range Extender | | |
| 17. Register | | |
| 18. MEM (Memory) | | |
| 19. To Store a Number/Name | | |
| 20. To Search For and Dial a Number/Name | | |
| 20. To Delete a Number/Name | | |
| 21. To Edit a Number/Name | | |
|
 | | |
| 22. Advanced Operations | | |
| 22. Handset and Base Operation | | |
| 22. Making Calls | | |
| 22. Answering Calls | | |
| 23. Page/Intercom | | |
| 24. Handsfree Speakerphone Operation | | |
| 24. Line in Use Indication | | |
| 24. Low Battery Indication | | |
| 25. Message Waiting Indication | | |
| 25. Conference Calling | | |
| 25. Transferring Calls | | |
| 26. Announced Transfer | | |
| 27. Custom pay-Per-Use (PPU) Features | | |
| 28. Headset Operation | | |



Printed in China

BS2425
91-005499-020-000
ISSUE 0

