

TABLE OF CONTENTS

IMPORTANT SAFETY INSTRUCTIONS.....	2
PARTS CHECK LIST.....	3
HANDSET LAYOUT.....	4
BASE LAYOUT.....	5
GETTING STARTED.....	6
Installation of Battery Pack in Handset.....	6
Setting up your VT 9123/9126.....	7
Ringer Selection.....	7
Tone / Pulse Selection.....	7
Wall Mounting.....	8
The Handset Display.....	9
BASIC OPERATION.....	10
Making Calls.....	10
Volume Control.....	10
Channel Changing.....	10
Using Redial.....	11
Answering Calls.....	11
Flash.....	11
Hold.....	12
Page.....	12
ADVANCED OPERATION.....	13
CALLER ID/CALL WAITING ID.....	13
Receiving and Storing Calls.....	13
About Call History.....	13
Review Caller ID	13
Deleting Records From Call History.....	14
Delete A Specific Call.....	14
Delete All Calls.....	14
Dial A Displayed Number.....	14
Store A Caller ID Record In Memory.....	14
Display Screen Messages.....	15
PHONE BOOK.....	16
Store Memory Numbers.....	16
Edit Numbers Stored In Memory.....	17
Delete Numbers Stored in Memory.....	17
Dial Memory Numbers.....	17
MESSAGES WAITING.....	18
OPTIONAL HEADSET INSTALLATION AND OPERATING INSTRUCTIONS.....	19
ADDITIONAL INFORMATION.....	20
Maintenance.....	20
In Case of Difficulty.....	21
Limited Warranty.....	23
FCC & IC Regulations.....	25
RBRC™ SEAL.....	27
Technical Specifications.....	28

IMPORTANT SAFETY INSTRUCTIONS

When using your telephone equipment, basic safety precautions should always be followed to reduce the risk of fire, electric shock and injury to persons, including the following:

1. Read and understand all instructions.
2. Follow all warnings and instructions marked on the product.
3. Unplug this product from the wall outlet before cleaning. Do not use liquid cleaners or aerosol cleaners. Use a damp cloth for cleaning.
4. Do not use this product near water (for example, near a bath tub, kitchen sink, or swimming pool).
5. Do not place this product on an unstable cart, stand, or table. The product may fall, causing serious damage to the product.
6. Slots and openings in the cabinet and the back or bottom are provided for ventilation. To protect it from overheating, these openings must not be blocked by placing the product on the bed, sofa, rug, or other similar surface. This product should never be placed near or over a radiator or heat register. This product should not be placed in a built-in installation where proper ventilation is not provided.
7. This product should be operated only from the type of power source indicated on the marking label. If you are not sure of the type of power supply to your home, consult your dealer or local power company.
8. Do not allow anything to rest on the power cord. Do not locate this product where the cord will be abused by persons walking on it.
9. Never push objects of any kind into this product through cabinet slots as they may touch dangerous voltage points or short out parts that could result in a risk of fire or electric shock. Never spill liquid of any kind on the product.
10. To reduce the risk of electric shock, do not disassemble this product. If service or repair work is required, contact VTECH Customer Service at 1-800-595-9511. Opening or removing cabinet parts other than specified access doors may expose you to dangerous voltages or other risks. Incorrect reassembling can cause electric shock when the appliance is subsequently used.
11. Do not overload wall outlets and extension cords as this can result in the risk of fire or electric shock.
12. Unplug this product from the wall outlet :
 - A. When the power supply cord or plug is damaged or frayed.
 - B. If liquid has been spilled into the product.
 - C. If the product has been exposed to rain or water.
 - D. If the product does not operate normally by the following the operating instructions. Adjust only those controls that are covered by the operating instructions because improper adjustment of other controls may result in damage and will often require extensive work to restore the product to normal operation.
 - E. If the product has been dropped and the cabinet has been damaged.
 - F. If the product exhibits a distinct change in performance.
13. Avoid using a telephone (other than a cordless type) during an electrical storm. There may be a remote risk of electric shock from lightning.
14. Do not use the telephone to report a gas leak in the vicinity of the leak.

SAVE THESE INSTRUCTIONS

PARTS CHECK LIST

1. Base Unit
2. Handset
3. Owner's Manual
4. AC Power Adaptor
5. Telephone Cord
6. Battery Pack
7. Belt Clip

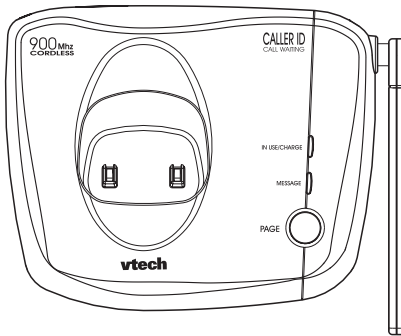

Base



Handset

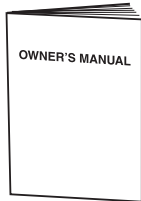

Owner's Manual

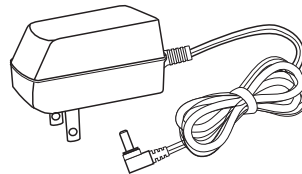

Adaptor

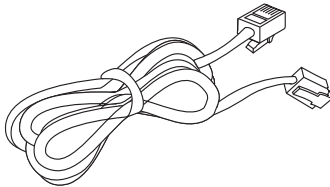

Telephone Line Cord



Battery Pack



Belt Clip

HANDSET LAYOUT

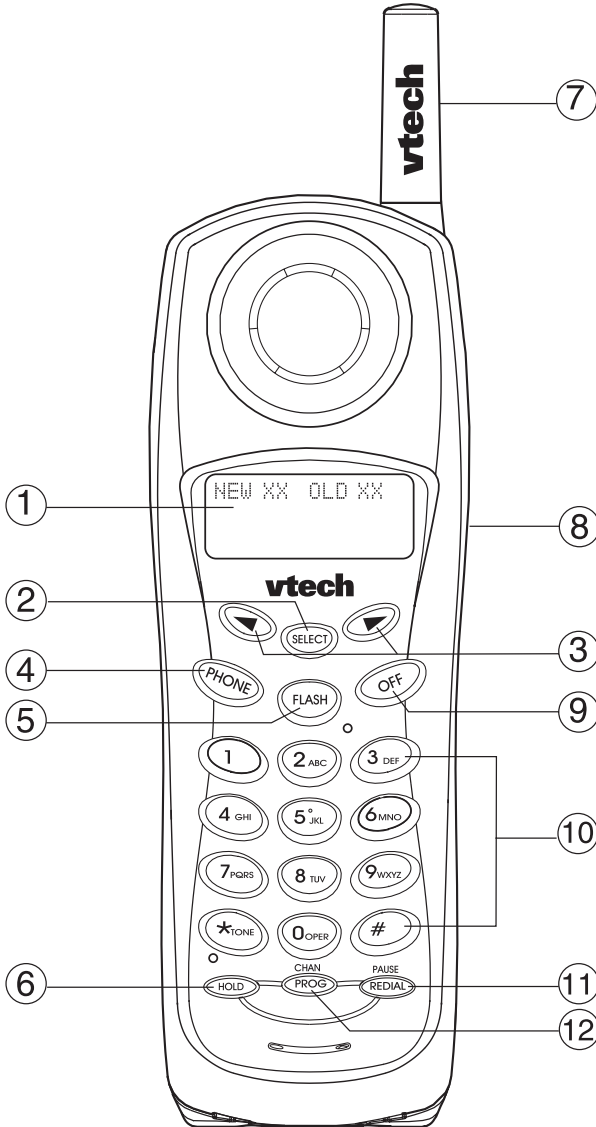

1. LCD Display
2. SELECT
3. Navigation/Volume Keys
4. PHONE
5. FLASH
6. HOLD

7. Antenna
8. Headset Jack
9. OFF
10. Dialing Keys
11. REDIAL
12. PROG

BASE LAYOUT

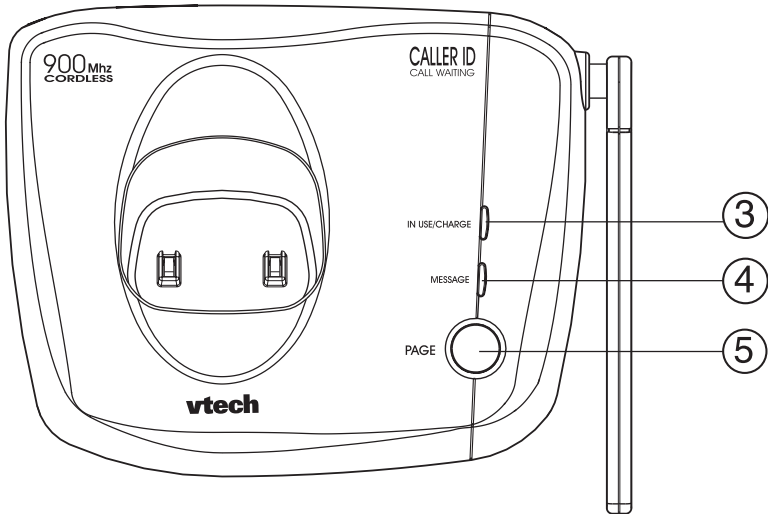
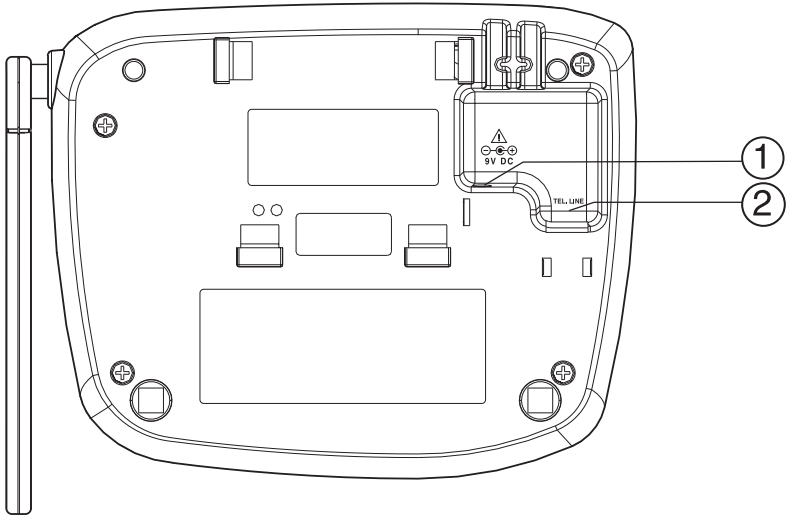

- 1. Power Jack
- 2. Telephone Line Jack
- 3. IN USE/CHARGE LED

- 4. MESSAGE Indicator
- 5. PAGE

INSTALLATION OF BATTERY PACK IN HANDSET

The Handset of your **VT 9123/9126** is powered by a rechargeable battery pack. It charges automatically whenever the Handset is in the Base Unit. The battery pack needs charging when:

- The low battery icon and message are displayed:
- A double beep will be generated every 5 seconds.

BATTERY LOW

To charge the battery pack, place the Handset in the Base Unit. The **IN USE/CHARGE** indicator will light to show the Handset is seated properly and the battery pack is charging. It is recommended that the battery pack should be charged for at least 16 hours initially. Afterwards, 8 hours of maintenance charging should be sufficient.

To replace the battery pack, follow the steps below:

1. Remove the battery case cover by pressing on the ridged lines and sliding downward.
2. Discard the old battery pack by pulling firmly on the battery cords. Don't put the old battery pack in a trash compactor or a fire - it could burst. Please recycle.
3. Snap in the new battery pack, with the wires in the lower left corner. Insert the battery plug into the socket, aligning the two holes in the plug with the socket pins.
4. Place the cord in the case so it rests below the battery pack.

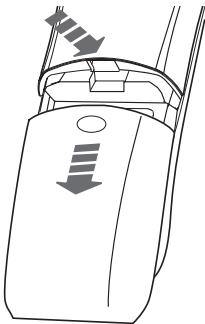

5. Replace the battery case cover by sliding the cover upwards.
6. Place the Handset in the cradle of the Base Unit to allow it to charge for 16 hours.

CAUTION: To Reduce the Risk of Fire or Injury, Read and Follow the Instructions

IMPORTANT:

Do not dispose of this battery pack into household garbage. For information on recycling or proper disposal, consult your local solid waste collection or disposal organization.

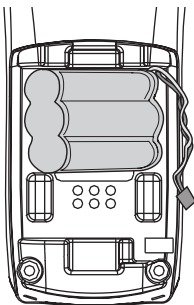

1. Use only VTech rechargeable battery pack, or equivalent.
2. Do not dispose of the battery pack in a fire. The cell may explode.
3. Do not open or mutilate the battery pack. Released electrolyte is corrosive and may cause damage to the eyes or skin. It may be toxic if swallowed.
4. Exercise care in handling batteries in order not to short the battery with conducting materials such as rings, bracelets, and keys. The battery pack or conductor may overheat and cause burns.

To purchase replacement battery packs, call VTech at 1-800-595-9511.

SETTING UP YOUR VT 9123/9126

RINGER SELECTION

1. Press **PROG/CHAN**.
2. Press **▼** or **▼** until **RINGER** is displayed.
3. Press **SELECT**. The current selection will be displayed, and you will hear a sample of the selected ring.
4. Press **▼** or **▼** to select a different ring style (there are 4), or turn the ringer **OFF**.
5. Press **SELECT** to confirm your choice.

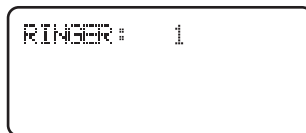

NOTE: If the ringer is set to OFF, the display will show "RINGER OFF" in idle mode.

TONE/PULSE SELECTION

NOTE: Your **VT 9123/9126** is factory-preset for **TONE** dialing.

1. To change dialing mode, press **PROG/CHAN**,
2. Press **▼** or **▼** until **DIAL MODE** is displayed.
3. Press **SELECT**. The current setting is displayed.
4. Press **▼** or **▼** to change the setting.
5. Press **SELECT** to confirm your choice.

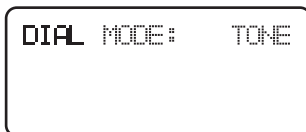

WALL MOUNTING

The Wall Mount bracket is designed for use on standard Wall Mount plates only.

1. Line up the tabs on the wall mount adaptor with the holes on the bottom of the Base Unit. Snap the wall mount bracket firmly in place.
2. Plug the AC adaptor into an electrical outlet, and the DC connector to the bottom of the Base Unit. If the Handset battery pack has not been charged previously, place the Handset in the Base Unit cradle, and allow it to charge for 16 hours.
3. Connect the telephone line cord to the jack on the bottom of the Base Unit, and the other end to the wall jack.
4. Mount the Base Unit on the wall. Position the Base Unit so the mounting stubs will fit into the holes on the wall mount bracket. Slide Base Unit down on the mounting stubs until it locks into place.
5. Flip down the wall mount tab on the Base to secure the Handset when cradled.

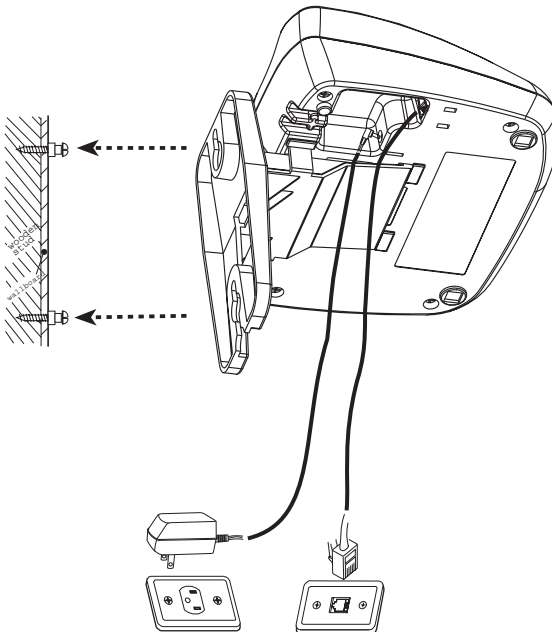

THE HANDSET DISPLAY

If the display says:

NEW 01 OLD 03

It means:

The Handset is in idle mode

NO LINE

A telephone line has not been connected to the Base Unit. Or the line is out of service.

*** RINGING ***

Indicates incoming call

CONNECTING...

Waiting for dial tone

PHONE

Handset is in use

EXTENSION IN USE

A parallel phone is in use

MESSAGES WAITING

Messages in your phone company Voicemail have been received

BASIC OPERATION

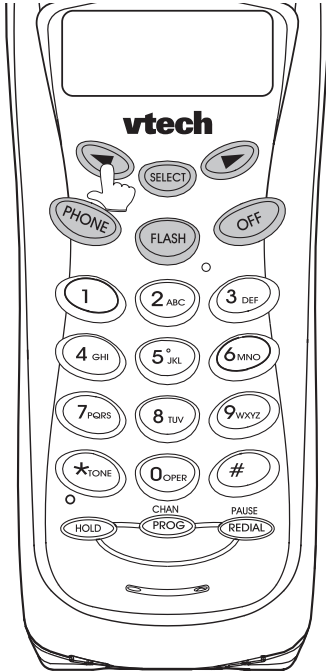

MAKING CALLS

Method 1-----Live Dialing

Press **PHONE**. Dial the phone number.



Press **OFF** to end your call.



Method 2-----Pre-dialing

Dial the phone number. Use the **▼** key to backspace if you make a dialing mistake. Then press **PHONE**.

Press **OFF** to end your call.

When the handset is in use, the **IN USE/CHARGE** light on the Base Unit will flash. When the Handset is in the Base Unit cradle, the **IN USE/CHARGE** light glows steadily.

VOLUME CONTROL

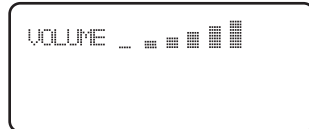
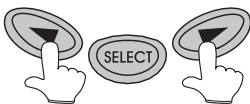

While you are on a call, press **▲** to raise the inbound volume and **▼** to lower it. The handset will display the relative volume setting as you adjust it.

CHANNEL CHANGING



If you experience noise or interference while on a call, you may be too far from the Base Unit, or in an obstructed area. Try moving to a different location. If this does not improve the transmission, press **PROG/CHAN**. You can press this key more than once, if necessary.

NOTE: This feature only operates while you are on an active call.

BASIC OPERATION

USING REDIAL

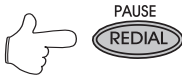

1. Press **PHONE**. Listen for dial tone.
2. Press **REDIAL/PAUSE**. The last number you called will automatically be redialed.

OR

1. Press **REDIAL**. The number will appear on the display.
2. Press **PHONE**.

NOTE: If you press **REDIAL** twice, the redial number will be deleted.

ANSWERING CALLS

To answer a call, press **any** key other than the **OFF** key.

During an incoming call, to temporarily mute the ringing, press **OFF**.
(Note: This feature is not available when the Handset is in its cradle.)

FLASH



When you receive a *Call Waiting* alert, press **FLASH** to switch to the incoming call.

Press **FLASH** again to return to the first call.

BASIC OPERATION



HOLD

To place your call on hold, press **HOLD**. Press **HOLD** again to return to your call.



NOTE: If you have a call on hold, and pick up a parallel extension phone, your **VT 9123/9126** will automatically drop the call and return to idle mode.

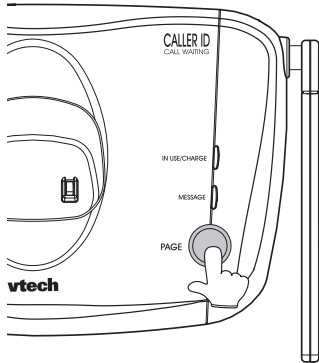

PAGE

The Base can signal the Handset by means of the PAGE key. This is helpful in locating a misplaced Handset. Press **PAGE** at the Base. The Handset will generate a series of tones (different than inbound call ringing) for a maximum of **60** seconds, and will display:

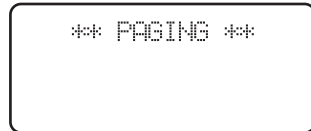

Press **PAGE** at the Base or **OFF** key on the Handset to end the Page.

CALLER ID/CALL WAITING ID

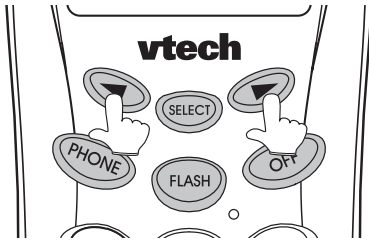

NOTE: Caller ID and Call Waiting ID are subscription services, provided by your regional phone company. You must subscribe to these services in order to benefit from the Caller ID features of your **VT 9123/9126**. Contact your regional phone service provider for details.

RECEIVING AND STORING CALLS

As new Caller ID/Call Waiting ID records are received, **NEW** followed by the number of new Caller ID records received will be displayed on the Handset.

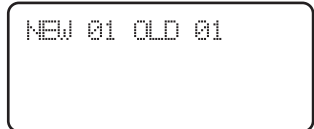

Your **VT 9123/9126** will store the most current **50** Caller ID and Call Waiting ID records. To review Caller ID records, press **▼** while the Handset is in the idle mode. Keep pressing **▼** to scroll through more records.



ABOUT CALL HISTORY

This phone assigns each incoming call a number from 1 to 50. The most recent call will have the highest number. When the memory is full, the oldest call information is deleted to make room for new incoming call information.

For each call that comes in, the screen displays the following information between the first and second rings:

- Your caller's name (15 letters are sent by your telephone company);
- The caller's area code and telephone number;
- The time and date of the call; and
- The position of the call in call history.

If you answer a call before the information appears on the screen, it will not be in the call history.

Note: Press **OFF** at any time to exit Caller ID review mode.

REVIEW CALLER ID

The screen displays call information for about 15 seconds after it has been received.

1. Press **▼** (CID) to view Caller ID.
2. Use **▼** and **▲** to scroll through records in call history.

CALLER ID/CALL WAITING ID

DELETING RECORDS FROM CALL HISTORY

DELETE A SPECIFIC CALL

1. Locate the record you want to delete from call history.
2. Press **SELECT**, then press ▼ until **ERASE** flashes.
3. Press **SELECT**. The screen displays **ERASE NO YES ALL** and the phone number. The current choice flashes.
4. Press ▼ until **YES** flashes.
5. Press **SELECT**. You'll hear a series of beeps confirming the deletion.



DIAL PGM ERASE
973-555-0123
5/01 5:40PM OLD 28

DELETE ALL CALLS

1. While viewing call history, press **SELECT**, then press ▼ until **ERASE** flashes.
2. Press **SELECT**. The screen displays **ERASE NO YES ALL** and the phone number. The current choice flashes.
3. Press ▼ until **ALL** flashes, then press **SELECT**. The screen displays **ERASE ALL NO YES**. The current choice flashes.
4. Press ▼ until **YES** flashes.
5. Press **SELECT**. You will hear a series of beeps confirming the deletion.



DIAL PGM ERASE
973-555-0123
5/01 5:40PM OLD 28

DIAL A DISPLAYED NUMBER

1. Locate the record in call history that you want to dial.
2. If you wish to change how the number is dialed, press **#**. The screen displays any alternate dialing sequences available for this call (area code + number; 1+ area code + number; 1+ number; number only).
3. Press **SELECT**, **DIAL** will be flashing.
4. Press **SELECT** again. The number will be dialed.



DIAL PGM ERASE
973-555-0123
5/01 5:40PM OLD 28

STORE A CALLER ID RECORD IN PHONE BOOK MEMORY

1. Use the ▼ key to locate the desired CID record.
2. If you wish to change how the number is stored, press **#**. The screen displays any alternate dialing sequence available for this call (area code + number; 1+ area code + number; 1+ number; number only).
3. Press **SELECT**, then press ▼ until **PGM** flashes.
4. Press **SELECT**. You can now edit the **NAME** if you wish. Press ▼ to backspace in order to edit the name.



DIAL PGM ERASE
973-555-0123
5/01 5:40PM OLD 28

CALLER ID/CALL WAITING ID

5. Press **SELECT**. You can now edit the PHONE NUMBER. Press ▼ to to backspace in order to edit the phone number.
6. Press **SELECT**. Your CID record is now in your Phone BOOK directory.

DISPLAY SCREEN MESSAGES

Screen Display:	When:
PRIVATE NAME	The other party is blocking name information.
PPP	The other party is blocking number information.
PRIVATE CALLER	The other party is blocking name and number information.
UNKNOWN NAME	Your phone company is unable to receive information about this caller's name.
UUU	Your phone company is unable to receive information about this caller's number.
UNKNOWN CALLER	Your phone company is unable to receive information about this caller's name and number.
EXTENSION IN USE	An extension phone on this line is being used, so call information cannot be received.
Err	There is a problem with Caller ID transmission from the telephone company.

PHONE BOOK

This cordless phone can store 20 telephone numbers with names, each up to 16 digits long. Entries are stored alphabetically. For consistency with Caller ID entries, you may wish to enter last names first.

Note: Press **OFF** at any time to exit memory.

STORE MEMORY NUMBERS

1. Press **PROG/CHAN**. The screen displays **DIRECTORY**.
2. Press **SELECT**. The screen displays **ENTER NAME**.
3. Using the chart below, enter up to 15 characters for the name you're storing with the number. Use **▼** to backspace and make corrections; use **▶** to advance and add a space.

Dial Key	Presses					
	1	2	3	4	5	6
1	1					
2	A	B	C	2		
3	D	E	F	3		
4	G	H	I	4		
5	J	K	L	5		
6	M	N	O	6		
7	P	Q	R	S	7	
8	T	U	V	8		
9	W	X	Y	Z	9	
0	0					
*	*					
#	&	'	,	-	.	#

4. When you finish entering the name, press **SELECT**. The screen displays **ENTER NUMBER**.
5. Enter the telephone number. Use **▼** to backspace and make a correction. Press **REDIAL/PAUSE** to store a pause in the dialing sequence.
6. Press **SELECT** to store your entry. The screen displays **SAVING...** and you'll hear a series of beeps confirming the entry.

Note: When memory is full the screen displays **MEMORY FULL**, an error tone sounds, and you will not be able to store a new number until you delete a stored number.

PHONE BOOK

EDIT NUMBERS STORED IN MEMORY

1. Press **▼** (DIR). The screen displays **DIRECTORY**.
2. Press **▼** or **▲** to scroll alphabetically through numbers stored in memory
-OR-
Press the dial pad key for the first letter of the entry you want to edit.
3. When the screen displays the number you want to edit, press **SELECT**. Then press **▼** until **EDIT** flashes.
4. Press **SELECT**. The screen displays the name and number. The flashing cursor appears at the end of the name. Use **▼**, **▲** and the dial pad keys to edit the name. Press **SELECT** to move on to edit the number.
5. Press **SELECT** to save the edited information. You'll hear a series of beeps confirming the change.

DELETE NUMBERS STORED IN MEMORY

1. Press **▼** (DIR). The screen displays **DIRECTORY**.
2. Press **▼** or **▲** to scroll alphabetically through numbers stored in memory
-OR-
Press the dial pad key for the first letter of the entry you want to delete.
3. When the screen displays the number you want to delete, press **SELECT**. Then press **▼** until **ERASE** flashes.
4. Press **SELECT**. The screen displays **ERASE NO YES** and the number. The current choice flashes.
5. Press **▼** until **YES** flashes.
6. Press **SELECT**. You'll hear a series of beeps confirming the deletion.

DIAL MEMORY NUMBERS

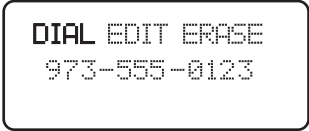
1. Press **▼** (DIR). The screen displays **DIRECTORY**.
2. Press **▼** or **▲** to scroll alphabetically through numbers stored in memory
-OR-
Press the dial pad key for the first letter of the entry you want to dial.
3. When the screen displays the number you want to dial, press **SELECT**. Then press **▼** or **▲** until **DIAL** flashing.
4. Press **SELECT**, The phone automatically dials the number.

MESSAGES WAITING

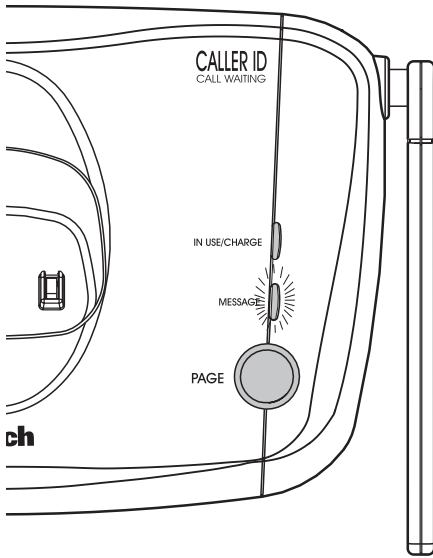

Your **VT 9123/9126** is capable of detecting a Visual Message Waiting signal, generated by many phone service providers. If you subscribe to VoiceMail service from your local telephone company, and a Visual Message Waiting Signal is provided, the Handset will display **MESSAGES WAITING** and the Base Unit **MESSAGE** light will glow to alert you to new, unplayed messages.



MESSAGES WAITING

Once you have reviewed all of your new messages the indicators will go out.

However, if necessary, it is possible to turn the Message Waiting indicators OFF manually:

1. Press **PROG/CHAN**.
2. Press **▼** or **▲** until **MESSAGES WAITING** is displayed.
3. Press **SELECT**. The Handset will display:
4. Press **▼** or **▲** to toggle between **NO** and **YES**.
5. Press **SELECT** to confirm your choice.



LIGHT OFF: YES

OPTIONAL HEADSET INSTALLATION & OPERATING INSTRUCTIONS

Your **VT 9123/9126** cordless telephone is equipped with a 2.5mm Headset Jack for use with an **optional** accessory Headset for hands-free operation.

If you choose to use the Headset option, you must do the following:

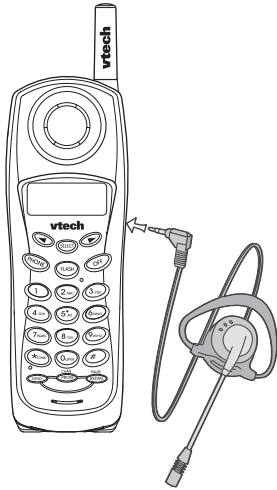

INSTALLATION

- * Obtain an optional accessory Head set, which is compatible with the **VT 9123/9126**.

Please contact **VTECH Communications Customer Service**, in the U.S. toll-free at **1-800-595-9511**, in the Canada call **1-800-267-7377** for dealer information in your local area. You can also purchase a compatible Headset directly from VTECH Communications Customer Service.

- * Once you have a compatible 2.5mm Headset, locate the Headset Jack on the Handset of your **VT 9123**. Connect the plug on the Headset to the jack on the cordless Handset. The plug should fit securely. Do not force the connection. See illustration.

OPERATION

NOTE: Whenever a compatible Headset is connected to the cordless Handset, the microphone on the Handset will be **MUTED**. This is done to limit the effect of background noise.

- * The following operational characteristics apply to VTECH Headsets. the same may also apply to other (non-VTECH) compatible headsets, but VTECH assumes no responsibility for their performance.
- * The VTECH brand compatible Headset has a monaural design which is reversible, so you can wear your Headset on either the left or right ear, leaving one ear free for room conversation.

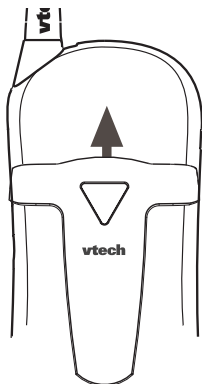

- * The headband can be adjusted to fit the contour of your head. Using both hands, slide the headband up or down so that it rests comfortably on your head with the speaker cushion centered against your ear.
- * For maximum sound quality, the flexible microphone should be positioned at the corner of your mouth, about one inch from your mouth.

BELT CLIP

- * The **VT 9123/9126** is also equipped with a detachable belt clip. Align the pins on the inside edge of the belt clip with the notches on the side of the **VT 9123/9126** handset. The belt clip should snap securely into place. Do not force the connection. See Illustration.

MAINTENANCE

TAKING CARE OF YOUR TELEPHONE

Your cordless telephone contains sophisticated electronic parts, so it must be treated with care.

AVOID ROUGH TREATMENT

Place the Handset down gently. Save the original packing materials to protect your telephone if you ever need to ship it.

AVOID WATER

Your telephone can be damaged if it gets wet. Do not use the Handset outdoors in the rain, or handle it with wet hands. Do not install your Base Unit near a sink, bathtub or shower.

ELECTRICAL STORMS

Electrical storms can sometimes cause power surges harmful to electronic equipment. For your own safety, use caution when using electric appliances during storms.

CLEANING YOUR TELEPHONE

Your telephone has a durable plastic casing that should retain its luster for many years. Clean it only with a soft cloth slightly dampened with water or a mild soap. Do not use excess water or cleaning solvents of any kind.

Remember that electrical appliances can cause serious injury if used when you are wet or standing in water. If your Base Unit should fall into water, **DO NOT RETRIEVE IT UNTIL YOU UNPLUG THE POWER CORD AND TELEPHONE LINE CORDS FROM THE WALL.** Then pull the unit out by the unplugged cords.

IN CASE OF DIFFICULTY

If you have difficulty operating your phone, the suggestions below should solve the problem. If you still have difficulty after trying these suggestions,

In the US call:

VTECH COMMUNICATIONS at 1-800-595-9511.

In Canada call:

VTECH ELECTRONICS at 1-800-267-7377.

THE PHONE DOESN'T WORK AT ALL.

- Make sure the power cord is plugged in.
- Make sure the telephone line cord is plugged firmly into the base unit and the telephone wall jack.
- Make sure the batteries are properly charged. If the Battery Low indicator is on, the battery needs charging. If the LCD display shows "**NEEDS RECHARGING**" :
you must charge the batteries.
- If you recently installed a new battery pack, make sure it is installed correctly.



NEEDS RECHARGING

NO DIAL TONE.

- First check all the suggestions above.
- If you still don't hear a dial tone, disconnect the base unit from the telephone jack and connect a different phone. If there is no dial tone on that phone either, the problem is in your wiring or local service. Call your local telephone company.

YOU GET NOISE, STATIC, OR A WEAK SIGNAL EVEN WHEN YOU'RE NEAR THE BASE UNIT.

- Place the handset in the base momentarily to re-set the unit. Then press PHONE to get a line.
- Household appliances plugged into the same circuit as the base unit can sometimes cause interference. Try moving the appliance or the base unit to another outlet.

YOU GET NOISE, STATIC, OR A WEAK SIGNAL WHEN YOU'RE AWAY FROM THE BASE UNIT.

- You may be out of range. Either move close to the base, or relocate the base unit.
- The layout of your home may be limiting the range. Try moving the base unit to the second or third floor, or to some other location.

IN CASE OF DIFFICULTY

THE HANDSET DOES NOT RING WHEN YOU RECEIVE A CALL.

- Ensure that the ringer is turned on.
- Make sure the telephone line cord is plugged firmly into the base unit and the telephone jack. Make sure the power cord is plugged in.
- You may be too far from the base unit.
- You may have too many extension phones on your telephone line to allow all of them to ring. Try unplugging some of the other phones.

YOUR CALLER FADES IN AND OUT.

- You may be nearly out of range. Move closer, or relocate the base.

YOU HEAR OTHER CALLS WHILE USING YOUR PHONE.

- Press **CHAN** key to switch to another channel.
- Disconnect your base unit from the telephone jack, and plug in a regular telephone. If you still hear other calls, the problem is probably in your wiring or local service. Call your local telephone company.

YOU HEAR NOISE IN THE HANDSET, AND NONE OF THE KEYS OR BUTTONS WORK.

- Make sure the power cord is plugged in.
- Your base unit and handset may not be operating on the same channel. Place the handset in the cradle for a few moments to reset the channel.

COMMON CURE FOR ELECTRONIC EQUIPMENT

Electronics, like people, can sometimes get confused. If the unit does not seem to be responding normally, then try putting the handset in the cradle to re-initialize the unit. If it still does not seem to respond, perform the following steps (in the order listed):

1. Disconnect the power to the base.
2. Disconnect (remove) the handset battery.
3. Wait a few minutes.
4. Connect power to the base.
5. Install the handset battery pack.
6. Put the handset in the base to re-initialize. If the handset has not been recently charged, allow 16 hours before use.

LIMITED WARRANTY

What does this limited warranty cover?

- The manufacturer of this **VTECH** product, **VTECH Communications**, warrants to the holder of a valid proof of purchase (“Consumer” or “you”) that the product and all accessories provided by **VTECH** in the sales package (“Product”) are free from material defects in material and workmanship, pursuant to the following terms and conditions, when installed and used normally and in accordance with operation instructions. This limited warranty extends only to the Consumer for Products purchased and used in the United States of America.

What will VTECH Communications do if the Product is not free from material defects in materials and workmanship during the limited warranty period (“Materially Defective Product”)?

- During the limited warranty period, **VTECH’s** authorized service representative will repair or replace, at **VTECH’s** option, without charge, a Materially Defective Product. If we repair this product, we may use new or refurbished replacement parts. If we choose to replace this product, we may replace it with a new or refurbished product of the same or similar design. **VTECH** will return repaired or replacement products to you in working condition. **VTECH** will retain defective parts, modules, or equipment. Repair or replacement of Product, at **VTECH’s** option, is your exclusive remedy. You should expect the repair or replacement to take approximately 30 days.

How long is the limited warranty period?

- The limited warranty period for the product extends for ONE (1) YEAR from the date of purchase.
If we repair or replace a Materially Defective Product under the terms of this limited warranty, this limited warranty also applies to repaired or replacement Products for a period of either (a) 90 days from the date the repaired or replacement Product is shipped to you or (b) the time remaining on the original one-year limited warranty, whichever is longer.

What is not covered by this limited warranty?

This limited warranty does not cover:

1. Product that has been subjected to misuse, accident, shipping or other physical damage, improper installation, abnormal operation or handling, neglect, inundation, fire, water, or other liquid intrusion; or
2. Product that has been damaged due to repair, alteration, or modification by anyone other than an authorized service representative of **VTECH**; or
3. Product to the extent that the problem experienced is caused by signal conditions, network reliability or cable or antenna systems; or
4. Product to the extent that the problem is caused by use with non- **VTECH** electrical accessories; or
5. Product whose warranty/quality stickers, Product serial numbers plates or electronic serial numbers have been removed, altered or rendered illegible; or
6. Product purchased, used, serviced, or shipped for repair from outside the United States, or used for commercial or institutional purposes (including but not limited to Products used for rental purposes); or
7. Product returned without valid proof of purchase (see 6 below); or
8. Charges for installation or set up, adjustment of customer controls, and installation or repair of systems outside the unit.

LIMITED WARRANTY

How do you get warranty service?

- To obtain warranty service in the United States of America, call 1-800-595-9511 for instructions regarding where to return the Product. Before calling for service, please check the user's manual. A check of the Product controls and features may save you a service call.
- Except as provided by applicable law, you assume the risk of loss or damage during transit and transportation and are responsible for delivery or handling charges incurred in the transport of Product(s) to the service location. **VTECH** will return repaired or replaced Product under this limited warranty to you, transportation, delivery or handling charges prepaid. **VTECH** assumes no risk for damage or loss of the Product in transit.
- If the Product failure is not covered by this limited warranty, or proof of purchase does not meet the terms of this limited warranty, **VTECH** will notify you and will request that you authorize the cost of repair prior to any further repair activity. You must pay for the cost of repair and return shipping costs for the repair of Products that are not covered by this limited warranty.

What must you return with the Product to get warranty service?

You must:

1. Return the entire original package and contents including the Product to the **VTECH** service location along with a description of the malfunction or difficulty;
2. Include "valid proof of purchase" (sales receipt) identifying the Product purchased (Product model) and the date of purchase or receipt; and
3. Provide your name, complete and correct mailing address, and telephone number.

Other limitations

- This warranty is the complete and exclusive agreement between you and **VTECH**. It supersedes all other written or oral communications related to this Product. **VTECH** provides no other warranties for this product. The warranty exclusively describes all of **VTECH's** responsibilities regarding the product. There are no other express warranties. No one is authorized to make modifications to this limited warranty and you should not rely on any such modification.

State Law Rights: This warranty gives you specific legal rights, and you may also have other rights which vary from state to state.

Limitations:

Implied warranties, including those of fitness for a particular purpose and merchantability (an unwritten warranty that the product is fit for ordinary use) are limited to one year from date of purchase.

Some states do not allow limitations on how long an implied warranty lasts, so the above limitation may not apply to you.

- In no event shall **VTECH** be liable for any indirect, special, incidental, consequential, or similar damages (including, but not limited to lost profits or revenue, inability to use the product, or other associated equipment, the cost of substitute equipment, and claims by third parties) resulting from the use of this product.

Some states do not allow the exclusion or limitation of incidental or consequential damages, so the above limitation or exclusion may not apply to you.

FCC & IC REGULATIONS

This equipment complies with Parts 15 and 68 of the Federal Communications Commission (**FCC**) rules for the United States. It also complies with regulations RSS210 and CS-03 of Industry and Science Canada. Operation is subject to the following two conditions: (1) this device may not cause interference, and (2) this device must accept any interference, including interference that may cause undesired operation of the device.

The underside of the Base Unit containing engravements of either the **FCC** registration number and Ringer Equivalence Number (**REN**), or the **IC** registration number. You must, upon request, provide this information to your local telephone company.

This equipment is compatible with inductively coupled hearing aids.

Should you experience trouble with this telephone equipment, please contact:

In the United States:

VTECH COMMUNICATIONS

1-800-595-9511.

In Canada:

VTECH ELECTRONICS

1-800-267-7377.

The telephone company may ask you to disconnect this equipment from the line network until the problem has been corrected.

FCC Part 15

Warning: Changes or modifications to this unit not expressly approved by the party responsible for compliance's could void the user's authority to operate the equipment.

The equipment has been tested and found to comply with part 15 of the FCC rules. These limits are designed to provide reasonable protection against harmful interference in a residential installation. This equipment generates, uses and can radiate radio frequency energy and, if not installed and used in accordance with the instructions, may cause harmful interference to radio communications. However, there is no guarantee that interference will not occur in a particular installation. If this equipment does cause harmful interference to radio or television reception, which can be determined by turning the equipment off and on, the user is encouraged to try and correct the interference by one or more of the following measures:

- Reorient or relocate the receiving antenna.
- Increase the separation between the equipment and receiver.
- Connect the equipment into an outlet or on a circuit different from that to which the receiver is connected.
- Consult the dealer or an experienced radio/TV technician for help.

FCC & IC REGULATIONS

FCC Part 68

The **FCC** requires that you connect your cordless telephone to the nationwide telephone network through a modular telephone jack (USOC RJ11C, RJ11W or RJ14).

Your telephone company may discontinue your service if your equipment causes harm to the telephone network. They will notify you in advance of disconnection, if possible. During notification, you will be informed of your right to file a complaint with the **FCC**.

Occasionally, your telephone company may make changes in its facilities, equipment, operation, or procedures that could affect the operation of your equipment. If so, you will be given advance notice of the change to give you an opportunity to maintain uninterrupted service.

The Base Unit contains no user serviceable parts. The Handset contains a user replaceable battery pack.

If it is determined that your telephone equipment is malfunctioning, the **FCC** requires that it not be used and that it be unplugged from the modular jack until the problem has been corrected. Repairs to this telephone equipment can only be made by the manufacturer or its authorized agents or by others who may be authorized by the **FCC**. For repair procedures, follow the instructions outlined under the Limited Warranty.

This equipment may not be used on coin service provided by the phone company or Party Lines.

The **REN** is useful in determining the number of devices you may connect to your telephone line and still enable the devices to ring when you receive a call. The general rule is that the **REN** value should not exceed 5.0 total; however, contact your local telephone company for the specific number in your area.

IC (Industry Canada)

This telephone is registered for use in Canada.

Notice: The Ringer Equivalence Number(REN) assigned to each terminal device denotes the percentage of the total load to be connected to a telephone loop which is used by the device, to prevent overloading. The termination of a loop may consist of any combination of devices subject only to the requirement that the sum of the Ringer Equivalent Numbers of all devices not exceed 5.0.

Notice: The Industry Canada label identifies certified equipment. This certification means that the equipment meets certain telecommunications network protective, operational and safety requirements. The Department does not guarantee the equipment will operate to the user's satisfaction.

Before installing this equipment, users should ensure that it is permissible to be connected to the facilities of the local telecommunications company. The equipment must also be installed using an acceptable method of connection. The customer should be aware that compliance with the above conditions may not prevent degradation of services in some situations.

FCC & IC REGULATIONS

Repairs to certified equipment should be made by an authorized Canadian maintenance facility designated by the supplier. Any repairs or alterations made by the user to this equipment, or equipment malfunctions, may give the telecommunications company cause to request the user to disconnect the equipment.

Users should ensure, for their own protection, that the electrical ground connections of the power utility, telephone lines and internal metallic water pipe system, if present, are connected together. This precaution may be particularly important in rural areas.

Caution: Users should not attempt to make such connections themselves, but should contact the appropriate electrical inspection authority, or electrician, as appropriate.

Your VTech **VT 9123/9126** is designed to operate at the maximum power allowed by the FCC and IC. This means your Handset and Base Unit can communicate only over a certain distance which will depend on the location of the Base Unit and Handset, weather, and the construction and layout of your home or office.

RBRC™ Seal



The **RBRC**® Seal on the nickel-cadmium battery contained in our product indicates that VTECH Communications, Inc. is voluntarily participating in an industry program to collect and recycle these batteries at the end of their useful lives, when taken out of service within the United States and Canada. The **RBRC**® program provides a convenient alternative to placing used nickel-cadmium batteries into the trash or municipal waste, which may be illegal in your area.

VTECH's partnership with **RBRC**® makes it easy for you to drop off the spent battery at local retailers participating in the **RBRC**® program or at authorized VTECH product service centers. Please call **1-800-8-BATTERY** for information on Ni-Cd battery recycling and disposal bans/restrictions in your area. VTECH's involvement in this program is part of its commitment to protecting our environment and conserving natural resources.

RBRC® is a registered trademark of Rechargeable Battery Recycling Corporation.

TECHNICAL SPECIFICATIONS

FREQUENCY CONTROL

Crystal Controlled Dual PLL Synthesizer

TRANSMIT FREQUENCY

Handset:

923.10 MHz to 927.75 MHz
(All 30 channels within this range)

Base Unit:

902.30 MHz to 906.65 MHz
(All 30 channels within this range)

RECEIVE FREQUENCY

Handset:

902.3 MHz to 906.65 MHz
(All 30 channels within this range)

Base Unit:

923.10 MHz to 927.75 MHz
(All 30 channels within this range)

NOMINAL EFFECTIVE RANGE

Maximum power allowed by FCC and IC. Actual operating range may vary according to environmental conditions at the time of use.

SIZE

Handset:

56(L) x 37(W) x 205(H)mm
Maximum (Antenna included)

Base Unit:

165(L) x 135(W) x 50(H)mm
Maximum (Antenna included)

WEIGHT

Handset:

160 grams

Base Unit:

210 grams

POWER REQUIREMENTS

Handset:

Self-contained nickel-cadmium rechargeable battery supply, 3.6V nominal, 400mAh capacity.

Base Unit:

9VDC @ 300mA

MEMORY

Phone Book:

20 Memory locations
16 digits and 15 characters per location.

CID:

Alpha Numeric Display 50 Memory locations

SPECIFICATIONS ARE TYPICAL AND MAY CHANGE WITHOUT NOTICE.



vtech

VTECH TELECOMMUNICATIONS LTD.



A member of THE VTECH GROUP OF COMPANIES.

Distributed in the U.S.A. by VTech Communications Inc, Beaverton, Oregon, 97008

Distributed in the Canada by VTech Electronics Canada Ltd., Suite 200-7671 Alderbridge Way Richmond, B.C. V6X 1Z9.

Copyright 2001 for VTECH TELECOMMUNICATIONS LTD.
Printed in China

91-5231-10-00
ISSUED 0