

# TABLE OF CONTENTS

<b>IMPORTANT SAFETY INSTRUCTIONS.....</b>	<b>3</b>
<b>INTRODUCTION.....</b>	<b>4</b>
<b>PARTS CHECK LIST.....</b>	<b>4</b>
<b>REPLACING THE HANDSET BATTERIES.....</b>	<b>5</b>
<b>GETTING STARTED.....</b>	<b>6</b>
<b>SETTING UP YOUR VT 9152.....</b>	<b>6</b>
<b>WALL MOUNTING.....</b>	<b>7</b>
<b>HANDSET FEATURES AND KEYS.....</b>	<b>8</b>
Phone/Flash.....	8
Off.....	8
Chan.....	8
Prog/Mem.....	8
Redial/Pause.....	8
Volume Up/Volume Down.....	8
Answering Machine.....	8
In Use/Low Batt LED.....	8
<b>BASE UNIT FEATURES AND KEYS.....</b>	<b>9</b>
New Message LED.....	9
Answer On/Off LED.....	9
In Use/Charging LED.....	9
Play/Stop.....	9
Repeat.....	9
Skip.....	9
Delete.....	9
Page.....	9
Volume.....	9
<b>BASIC OPERATION.....</b>	<b>10</b>
<b>USING YOUR VT 9152 CORDLESS TELEPHONE.....</b>	<b>10</b>
Making Calls.....	10
Answering Calls.....	10
Handset Volume Control.....	10
Ending a Call.....	10
Redial.....	10
Changing Channels.....	10
Tone/Pulse Setting.....	10
Temporary Tone.....	10
Ringer Programming.....	10
Checking the Ringer.....	10
Memory Dialing.....	11
Programming Speed Dial Numbers.....	11
Speed Dialing.....	11
To Change or Replace a Speed Dial Number.....	11
Storing Pauses in Memory.....	11
<b>ANSWERING SYSTEM OPERATION.....</b>	<b>12</b>
Introduction.....	12
Call Screening from Base Unit.....	12
Call Screening from Handset.....	12
<b>HANDSET LAYOUT FOR ANSWERING SYSTEM OPERATION.....</b>	<b>13</b>
Key Function.....	13
<b>ADVANCED OPERATION.....</b>	<b>14</b>
<b>ANSWERING SYSTEM SETUP.....</b>	<b>14</b>
Set Outgoing Message.....	14

# TABLE OF CONTENTS

---

Set Security Code.....	14
Set Day & Time.....	14
Set Audible Message Alert.....	14
Set Announce Only.....	14
Set Base Ringer.....	15
Set Number of Rings.....	15
Checking Day and Time.....	15
Recording a Memo.....	15
Turning Your Answering System ON/OFF.....	15
Playback of Greetings, Messages and Memos.....	16
<b>REMOTE OPERATION OF YOUR VT 9152 ANSWERING SYSTEM.....</b>	<b>17</b>
Remote Commands.....	17
<b>HEADSET OPERATION.....</b>	<b>18</b>
Belt Clip.....	18
Operation.....	18
<b>ADDITIONAL INFORMATION.....</b>	<b>19</b>
<b>IN CASE OF DIFFICULTY.....</b>	<b>19</b>
<b>LIMITED WARRANTY STATEMENT.....</b>	<b>21</b>
<b>FCC AND IC REGULATIONS.....</b>	<b>23</b>
<b>THE RBRC® SEAL.....</b>	<b>24</b>
<b>MAINTENANCE.....</b>	<b>25</b>
<b>TECHNICAL SPECIFICATIONS.....</b>	<b>26</b>

# **IMPORTANT SAFETY INSTRUCTIONS**

---

When using your telephone equipment, basic safety precautions should always be followed to reduce the risk of fire, electric shock and injury to persons, including the following:

1. Read and understand all instructions.
2. Follow all warnings and instructions marked on the product.
3. Unplug this product from the wall outlet before cleaning. Do not use liquid cleaners or aerosol cleaners. Use a damp cloth for cleaning.
4. Do not use this product near water (for example, near a bath tub, kitchen sink, or swimming pool).
5. Do not place this product on an unstable cart, stand, or table. The product may fall, causing serious damage to the product.
6. Slots and openings in the cabinet and the back or bottom are provided for ventilation. To protect it from overheating, these openings must not be blocked by placing the product on the bed, sofa, rug, or other similar surface. This product should never be placed near or over a radiator or heat register. This product should not be placed in a built-in installation where proper ventilation is not provided.
7. This product should be operated only from the type of power source indicated on the marking label. If you are not sure of the type of power supply to your home, consult your dealer or local power company.
8. Do not allow anything to rest on the power cord. Do not locate this product where the cord will be abused by persons walking on it.
9. Never push objects of any kind into this product through cabinet slots as they may touch dangerous voltage points or short out parts that could result in a risk of fire or electric shock. Never spill liquid of any kind on the product.
10. To reduce the risk of electric shock, do not disassemble this product. If service or repair work is required, contact VTECH Customer Service at 1-800-595-9511. Opening or removing cabinet parts other than specified access doors may expose you to dangerous voltages or other risks. Incorrect reassembling can cause electric shock when the appliance is subsequently used.
11. Do not overload wall outlets and extension cords as this can result in the risk of fire or electric shock.
12. Unplug this product from the wall outlet :
  - A. When the power supply cord or plug is damaged or frayed.
  - B. If liquid has been spilled into the product.
  - C. If the product has been exposed to rain or water.
  - D. If the product does not operate normally by the following the operating instructions. Adjust only those controls that are covered by the operating instructions because improper adjustment of other controls may result in damage and will often require extensive work to restore the product to normal operation.
  - E. If the product has been dropped and the cabinet has been damaged.
  - F. If the product exhibits a distinct change in performance.
13. Avoid using a telephone (other than a cordless type) during an electrical storm. There may be a remote risk of electric shock from lightning.
14. Do not use the telephone to report a gas leak in the vicinity of the leak.

**SAVE THESE INSTRUCTIONS**

# INTRODUCTION

## Parts Check List:

1. Base Unit
2. Handset
3. Wall Mount Bracket
4. Owner's Manual
5. AC Adaptor
6. Telephone Line Cord
7. Battery Pack
8. Belt Clip

To purchase replacement battery packs, call VTECH Communications at 1-800-595-9511. In Canada, call VTECH Electronics at 1-800-267-7377.

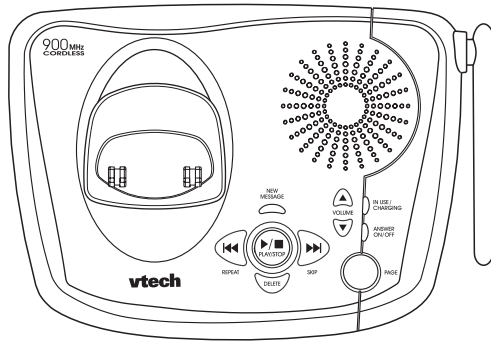

Base Unit



Handset

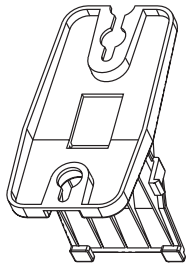

Wall Mount Bracket

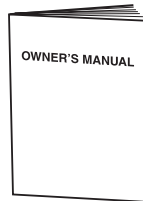

Owner's Manual

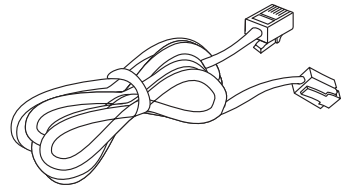

Telephone Line Cord

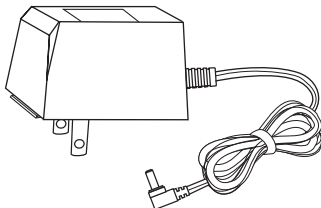

AC Adaptor



Battery Pack

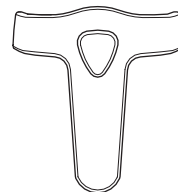

Belt Clip

# REPLACING THE HANDSET BATTERIES

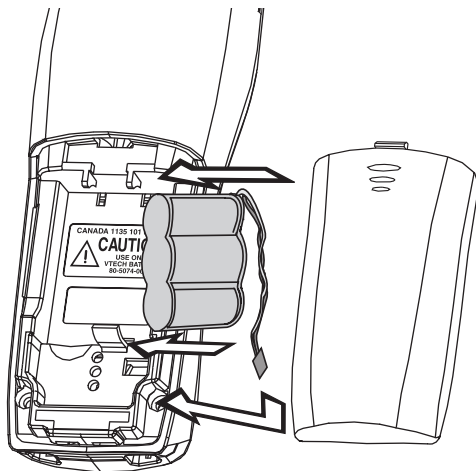

1. Slide the battery cover off by gently pressing on the recessed area with a downward motion.
2. Unplug and remove the old battery pack. Don't put the old battery pack in a trash compactor or a fire - it could burst.
3. Plug in the replacement battery pack. Place the battery pack in the compartment with the battery cord resting on top of it.
4. Replace the battery cover by sliding it into place.
5. The new battery pack must be charged before using your telephone. Place the handset in the cradle of the base unit to allow it to charge for 16 hours.

**CAUTION:** To reduce the risk of fire or injury, read and follow these instructions:

1. Use only **VTECH** battery pack.
2. Do not open or mutilate the battery. Released electrolyte is corrosive and may cause damage to the eyes or skin. It may be toxic if swallowed.
3. Exercise care in handling batteries in order not to short the battery with conducting materials such as rings, bracelets, and keys. The battery or conductor may overheat and cause burns.
4. Do not dispose of the battery in a fire. The cell may explode.

## Recharging the Battery Pack

Your **VT 9152** provides both audible and visual alerts when the battery pack is low and requires charging. Return the Handset to the Base cradle when:

1. The **IN USE/LOW BATT** LED is slowly flashing; and/or
2. You hear a *double beep* while you're on a call or when you press **PHONE/FLASH** to make or answer a call.

When fully charged, you will experience up to **5** hours of continuous talk, or up to **6** days of standby (off the cradle, but not in use).

## SETTING UP YOUR VT 9152

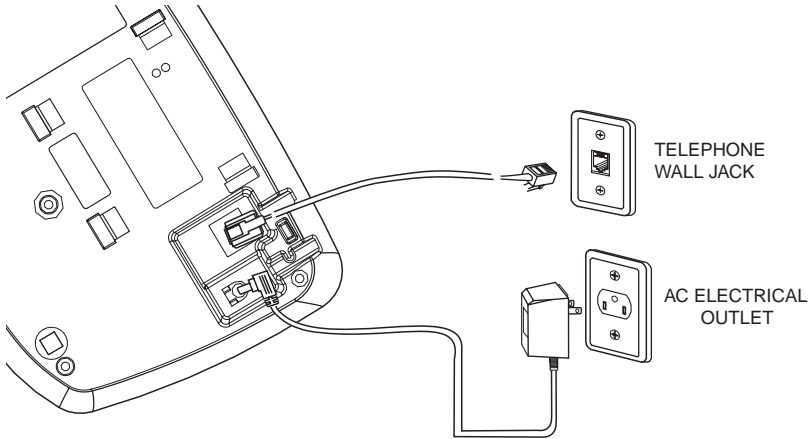

1. Choose an area near an electrical outlet and a telephone wall jack.
2. Plug the AC power adapter into an electrical outlet and the DC connector to the back of the base unit.

**CAUTION:** Use only the AC adapter shipped with your VT 9152. It is specifically designed for this product.

**NOTE:** Connect power to the base unit before placing the handset in the cradle.

3. **CHARGE THE HANDSET BATTERY PACK BEFORE USE.** The batteries recharge automatically whenever the handset is in the base unit cradle. The batteries must be charged for 16 hours before using your phone for the first time.
4. Connect the telephone line cord. Insert one end of the telephone line cord into the jack at the rear of the base unit. Plug the other end into a telephone wall jack. Make sure the plugs snap securely into place.
5. **CHECK FOR A DIAL TONE.** After the batteries are charged, pick up the handset and press the **PHONE** key. The **IN USE** indicator should light up, and you should hear a dial tone. If not, see **IN CASE OF DIFFICULTY**.

### **CAUTION:**

1. Never install telephone wiring during a lightning storm.
2. Never install telephone jacks in wet locations unless the jack is specifically designed for wet locations.
3. Never touch uninsulated telephone wires or terminals unless the telephone line has been disconnected at the network interface.
4. Use caution when installing or modifying telephone lines.

# WALL MOUNTING

1. **Choose a spot near an electrical outlet and a telephone jack.** Your phone requires a modular telephone jack and a standard electrical outlet (120V AC). The power cord is six feet long; make sure there is an electrical outlet within reach of the base. The outlet should not be controlled by a wall switch. If the switch is ever turned off, the phone will not operate.
2. **Attach the wall mount bracket** to the slots located on the underside of the Base Unit.
3. **Mount the Base on the wall.** Position the wall mount bracket so that the 2 holes in the bracket are aligned with the wall studs. Position the power and telephone line cords to extend down the wall to which the phone is to be mounted.
4. **Connect the power cord.** Plug the DC connector into the DC jack on the bottom of the Base Unit. Plug the AC power adapter into an electrical outlet.
5. **Connect the telephone line cord.** The telephone line cord has a snap-in plug at each end. Insert one of the plugs into the jack on the bottom of the base. Insert the other end of the plug into the wall jack.

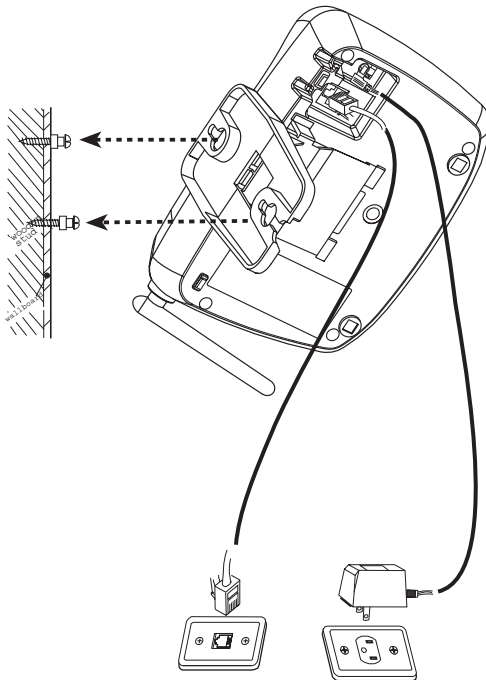

## HANDSET FEATURES AND KEYS

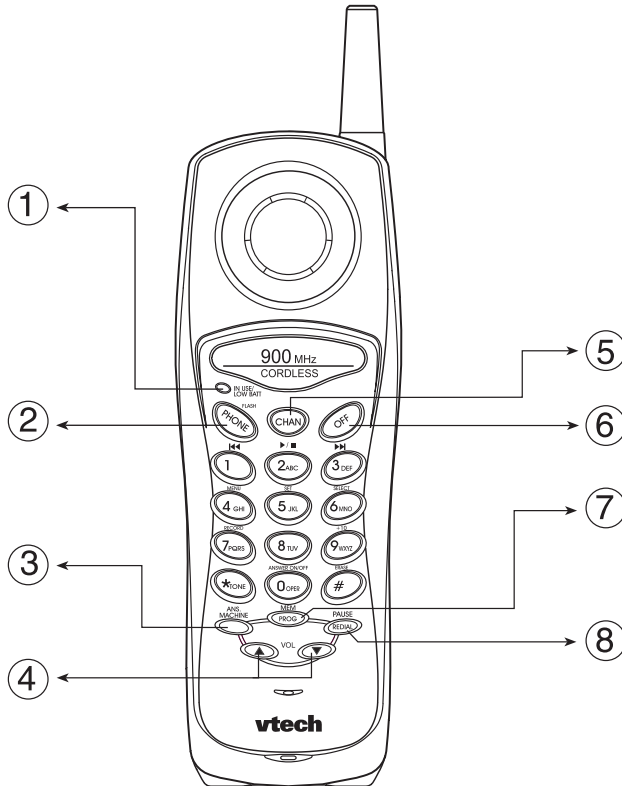
**1. IN USE/LOW BATT LED**

- \* Glows when the Handset is in use.
- \* Flashes during programming mode.
- \* Flashes in cadence with incoming ringing.
- \* Flashes slowly when the battery pack needs recharging.

**2. PHONE/FLASH**

- \* Press this key to answer a call or get a dial tone. While on a call, when you receive a *Call Waiting* alert, press **PHONE/FLASH** to switch between calls.

**3. ANSWERING MACHINE**

- \* Press this key to enter **Answering System** mode. It will illuminate while the Handset is controlling the Answering System. It will also flash to alert you to new messages. See the section **HANDSET LAYOUT FOR ANSWERING SYSTEM OPERATION** for more details.

**4. VOLUME UP▲ / VOLUME DOWN▼**

- \* These keys will raise and lower the earpiece volume while either in **PHONE** or **ANSWERING SYSTEM** mode.

**5. CHAN**

- \* If you experience noise or interference while on a call, press **CHAN** to switch to a clear channel.

**6. OFF**

- \* Press this key to end a call. The **OFF** key is also used to exit all modes of operation.

**7. PROG/MEM**

- \* This key is used to enter *Programming* mode, as well as *Memory Dial* mode.

**8. REDIAL/PAUSE**

- \* With the Handset **ON**, pressing this key will dial the last number you called. In Programming mode, **REDIAL/PAUSE** will add a 4 second pause to a dialing sequence.

# BASE UNIT FEATURES AND KEYS

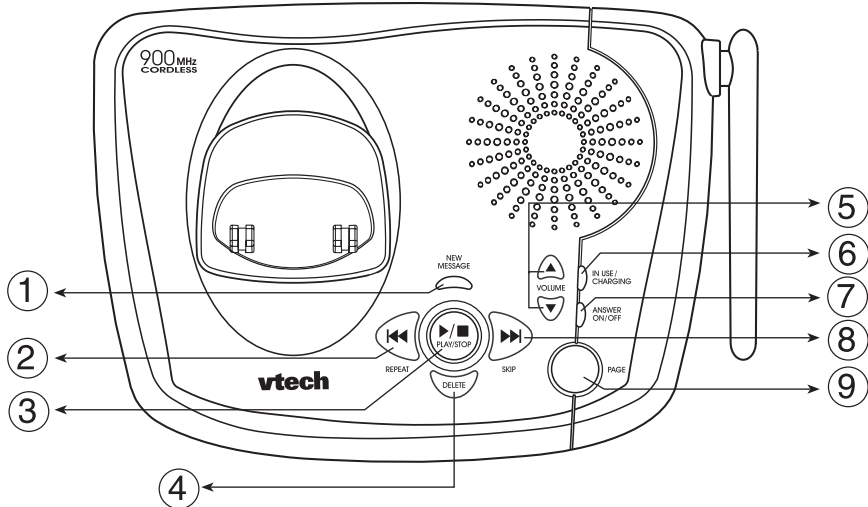

## 1. NEW MESSAGE LED

- \* Flashes slowly to indicate new messages; Glows steadily to indicate old (previously heard) messages; Flashes rapidly to indicate that the Answering System Memory is **FULL**.

## 2. REPEAT

- \* During message playback, press **REPEAT** to return to the beginning of the messages being played. Hold down the **REPEAT** key to slow down messages playback.

## 3. PLAY/STOP

- \* Press to play messages; press again to stop.

## 4. DELETE

- \* During message playback, press **DELETE** to erase the message being played. During idle mode, press **DELETE** to erase **all** previously played messages.

## 5. VOLUME

- \* Raise or lower the Base Unit speaker volume. There are **8** volume levels. At the lowest level (Level **1**), incoming messages cannot be screened at the Base Unit as they come in.

## 6. IN USE/CHARGING LED

- \* Flashes slowly when the Handset is in **TALK** mode; Flashes in cadence with the inbound ringing; Glows when the Handset is charging in the Base Unit cradle; Flashes when Handset is in **ANSWERING SYSTEM** mode.

## 7. ANSWER ON/OFF LED

- \* Glows steadily when the Answering System is **ON** and the day and time has been set; Flashes to indicate that the day and time need to be set.

## 8. SKIP

- \* During message playback, press **SKIP** to the next message. Hold down the **SKIP** key to speed up message playback.

## 9. PAGE

- \* Press **PAGE** to engage the Handset in a ring sequence, which will last for 60 seconds. You can end the page by pressing **PAGE** again on the Base Unit, or pressing **OFF** on the Handset.

# USING YOUR VT 9152 CORDLESS TELEPHONE

## MAKING CALLS

Pick up the Handset and press **PHONE/FLASH**. When you hear a dial tone, dial the number. The **IN USE/LOW BATT** LED will illuminate when the Handset is in use.

If you make a mistake when dialing, press **OFF** to hang up, then press **PHONE/FLASH** to get a dial tone again.

## ANSWERING CALLS

When the Handset rings, the **IN USE/LOW BATT** LED will flash on the Handset and the **IN USE/CHARGING** LED will flash on the Base Unit. Press **any** key on the Handset except **OFF**. If the Handset is in the Base Unit, simply pick it up to answer the call.

## HANDSET VOLUME CONTROL

Use the **Volume UP** and **DOWN** keys, located on the bottom of the Handset keypad to adjust the earpiece volume to a comfortable level.

## ENDING A CALL

Say "Bye-Bye", then either press **OFF** on the Handset, or place the Handset in the Base Unit cradle.

## REDIAL

Press the **REDIAL/PAUSE** key to dial the last number you called. The Handset must be **In Use** for this feature to function.

## CHANGING CHANNELS

If you notice noise or interference when using your Handset, press **CHAN** to switch to a clear channel. The feature only works when the Handset is in use.

## TONE/PULSE SETTING

Your **VT 9152** is factory preset for **TONE** dialing. If you require **PULSE (ROTARY)** dialing, press **PROG/MEM**, **\***, **#**, **PROG/MEM** to switch to **Pulse** dialing. To go back to **TONE** dialing, press **PROG/MEM**, **\***, **\***, **PROG/MEM**.

## TEMPORARY TONE

If you have rotary (Pulse) service, this feature allows you to enter **Tone** dialing mode easily. After making your call, simply press the **\*TONE** key. You are now dialing in **TONE** mode. Once you press **OFF** to end your call, your Handset will revert to **Pulse** dialing mode.

## RINGER PROGRAMMING

You can choose among **4** ring styles. You can also turn the Handset ringer **off**.

- Press **PROG/MEM**
- Press **#**
- Press **1,2,3** or **4** to hear the various styles; or press **5** to turn the Handset ringer **off**
- Press **PROG/MEM** to confirm your choice

## CHECKING THE RINGER

- Press **PROG/MEM**
- Press **#**
- Press **0**
- Press **PROG/MEM** to exit

# USING YOUR VT 9152 CORDLESS TELEPHONE

---

## MEMORY DIALING

Your VT 9152 stores up to 10 phone numbers that you can access by pressing **PROG/MEM** and one of the number keys, **0 – 9**.

## PROGRAMMING SPEED DIAL NUMBERS

- Press **PROG/MEM**
- Press a **Memory Location (0 – 9)**
- Dial the phone number. It can be up to **16** digits long.
- Press **PROG/MEM**. The phone number is now programmed to the location you selected.

## SPEED DIALING

- Press **PHONE/FLASH**
- Press **PROG/MEM**, followed by the **Memory Location (0-9)**

## TO CHANGE OR REPLACE A SPEED DIAL NUMBER

Follow the steps in **PROGRAMMING SPEED DIAL NUMBERS**.

## STORING PAUSES IN MEMORY

When you enter the phone number, press **REDIAL/PAUSE**. A 4 second pause will be inserted in the dialing sequence. For a longer pause, press **REDIAL/PAUSE** 2 or more times. Each pause is treated as a digit.

# ANSWERING SYSTEM OPERATION

---

## INTRODUCTION

Your **VT 9152** has a digital Answering Device in the Base Unit, capable of storing approximately 12 minutes of messages.

**USE THE VT 9152 HANDSET TO PROGRAM YOUR ANSWERING SYSTEM!!!**

- You can listen to your messages from the **Handset** or the **Base Unit**.
- You can also screen messages while your callers leave them from either the **Handset** or the **Base Unit**.

### Call Screening from Base Unit

Simply keep the Base Unit volume level above the minimum setting. You will hear messages at the Base Unit as your callers leave them.

### Call Screening from Handset

Press **ANS. MACHINE** on the Handset as a message comes in. You will be able to hear your caller, but your caller cannot hear you. If you want to talk to your caller now, press **PHONE/FLASH**. The answering system will return to idle mode.

# HANDSET LAYOUT FOR ANSWERING SYSTEM OPERATION

With the Handset in the idle mode (on hook), first press **ANS. MACHINE** to enter Answering System mode, then one of the following keys:

KEY	FUNCTION
1	Repeat current message
2	Play/Stop
3	Skip to the next message
4	MENU (for programming your Answering System)
5	SET (for programming your Answering System)
6	SELECT (for programming your Answering System)
7	Record
9	Increment by 10 (for programming time and security code)
0	Answering System ON/OFF
#	Erase

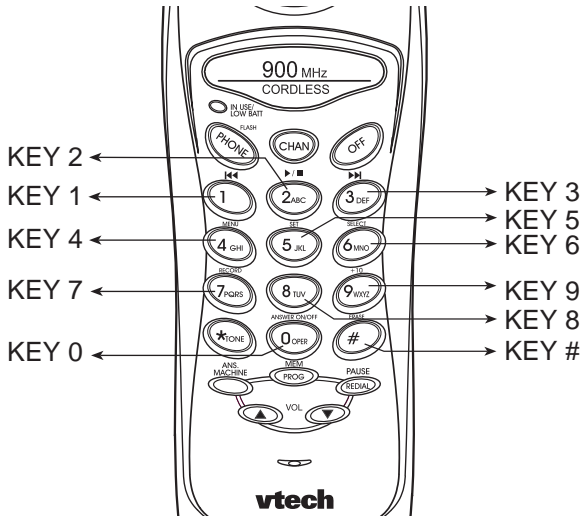

# ANSWERING SYSTEM SETUP

Before using your **VT 9152** Answering System, follow these programming steps:

## 1 SET OUTGOING MESSAGE

Record your greeting to be heard by callers. If you do not record a greeting, your **VT 9152** will play a default greeting.

- Press **ANS. MACHINE** on the Handset
- Press **4 (MENU)**. The voice prompt says "Set Outgoing Message".
- Press **7 (Record)**. The voice prompt says "Now Recording", followed by a beep. Speak into the Handset to record your announcement. Press **2 (Stop)** when done. Your recorded announcement will be played for you.

## 2 SET SECURITY CODE

Your 2 digit security code gives you access to your **VT 9152** Answering System from a telephone at a different location. Factory preset to **19**, your security code can be any number, from **00** to **99**.

- Press **ANS. MACHINE** on the Handset
- Press **4 (MENU)** twice, until you hear: "Set Security Code".
- Press **6 (SELECT)** to increment the security code by one per each press. Press **9** to increment by 10.
- Press **5 (SET)** to confirm your security code selection. You can either press **4 (MENU)** to continue programming, or **OFF** to exit programming.

## 3 SET DAY & TIME

- Press **ANS. MACHINE** on the Handset.
- Press **4 (MENU)** three times. You will hear: "Set Day and Time".
- Press **6 (SELECT)** until hear the correct day; then press **5 (SET)**.
- Press **6 (SELECT)** until you hear the correct hour, then press **5 (SET)**.
- Press **6 (SELECT)** until you hear the correct minute (or press **9** to increment the minutes by 10), then press **5 (SET)**. You can now either press **4 (MENU)** to continue programming, or **OFF** to exit.

## 4 SET AUDIBLE MESSAGE ALERT

This feature provides a beep tone at the Base Unit every 10 seconds, alerting you to new messages.

- Press **ANS. MACHINE** on the Handset.
- Press **4 (MENU)** four times. You will hear: "Set Audible Message Alert".
- Press **6 (SELECT)** to toggle between **On** and **Off**.
- Press **5 (SET)** to confirm your selection.
- Press **4 (MENU)** to continue programming, or **OFF** to exit.

## 5 SET ANNOUNCE ONLY

Your **VT 9152** Answering System can also play your greeting, without taking messages from callers. In this case, **ANNOUNCE ONLY** is set to **ON**.

- Press **ANS. MACHINE** on the Handset.
- Press **4 (MENU)** five times. You will hear: "Set Announce Only".
- Press **6 (SELECT)** to toggle between **On** and **Off**.
- Press **5 (SET)** to confirm your selection.
- Press **4 (MENU)** to continue programming, or **OFF** to exit.

# ANSWERING SYSTEM SETUP

Now, follow the steps in **1 SET OUTGOING MESSAGE** to record your “Announce Only” greeting. The **VT 9152** Answering System will retain **both** outgoing greetings; one for **Normal** (record messages) mode, and one for **Announce Only** mode.

**NOTE!!!! THE ANSWERING SYSTEM IS PRESET AT THE FACTORY FOR ANNOUNCE ONLY OFF. THIS IS THE NORMAL MODE, REQUIRED FOR YOUR VT 9152 TO RECEIVE MESSAGES FROM CALLERS.**

## 6 SET BASE RINGER

You can turn your Base Unit On or Off. This is independent of the Handset ringer.

- Press **ANS. MACHINE** on the Handset.
- Press **4 (MENU) six times**. You will hear “Set Base Ringer”.
- Press **6 (SELECT)** to toggle between **On** and **Off**.
- Press **5 (SET)** to confirm your selection.
- Press **4 (MENU)** to continue programming, or **OFF** to exit.

## 7 SET NUMBER OF RINGS

Choose between **2, 4, 6,** or **Toll Saver**. Toll Saver will cause the Answering System to activate after **4** rings if there are no new, unplayed messages, and after **2** rings if there are new, unplayed messages.

- Press **ANS. MACHINE** on the Handset.
- Press **4 (MENU) seven times**. You will hear: “Set Number of Rings”.
- Press **6 (SELECT)** to choose between **2, 4, 6** and **Toll Saver**.
- Press **5 (SET)** to confirm your selection.
- Press **4 (MENU)** to continue programming, or **OFF** to exit.

**NOTE: DURING PROGRAMMING, PRESS **ANS. MACHINE** OR **OFF** AT ANY TIME TO EXIT.**

## CHECKING DAY AND TIME

- Press **ANS. MACHINE** on the Handset.
- Press **5 (SET)**. The current Day and Time setting can be heard from the Handset earpiece.

## RECORDING A MEMO

- Press **ANS. MACHINE** on the Handset.
- Press **7 (RECORD)**. After the prompt: “Now Recording”, speak into the Handset.
- Press **OFF** or **ANS. MACHINE** to end recording and exit Answering System mode, or press **2 (STOP)** to end recording and stay in Answering System mode.

## TURNING YOUR ANSWERING SYSTEM ON/OFF

Your **VT 9152** Answering System is turned **ON** when you first apply power to it. From the Handset you can turn the system **ON** and **OFF**.

- Press **ANS. MACHINE** on the Handset.
- Press **0**. Through the earpiece, you will hear “Answering Machine **OFF** (or **ON**). Continued presses of the **0** key will toggle between **ON** and **OFF**.
- Press **OFF** to exit programming mode.

# ANSWERING SYSTEM SETUP

## PLAYBACK OF GREETINGS, MESSAGES AND MEMOS

### From the Base Unit

Use the **PLAY/STOP** to start and stop playback of messages and memos.

- Press the **>> SKIP** key to jump ahead to the next message.
- Hold the **>> SKIP** key to speed up message playback.
- Press the **<< REPEAT** key to return to the beginning of the current message. 2 consecutive presses of the **<< REPEAT** key will take you back to the previous message.
- Hold the **<< REPEAT** key to slow down message playback.
- Press **DELETE** while a message is playing to erase that message.
- Press and Hold **DELETE** while the Answering System is idle to erase **all** previously heard messages.
- Adjust the Base Unit speaker volume using the **VOL UP ▲** and **DOWN ▼** keys.

The **NEW MESSAGE** LED blinks when there are new messages. It glows steadily when it contains only old, previously heard messages.

### From the Handset

- Press **ANS.SYSTEM** on the Handset.
- Press **2 (PLAY)** to hear messages from the Handset.
- Press **1** to **repeat** the message; press **3** to **skip** to the next message.
- Press **# (DELETE)** to erase the current message.
- Press **OFF** or **ANS. MACHINE** to end message playback and exit Answering System mode; or press **2 (STOP)** to end message playback and stay in Answering System mode.

**NOTE: YOUR VT 9152 prevents accidental erasure of unplayed messages**

### To Hear Your Outgoing Greeting

- Press **ANS.MACHINE** on the Handset.
- Press **4 (MENU)**.
- Press **2 (PLAY/STOP)**.
- Press **4 (MENU)** to continue programming, or **OFF** to exit.

## REMOTE OPERATION OF YOUR VT 9152 ANSWERING SYSTEM

---

You can access messages and change your greeting remotely, using a touch tone phone from a different line or location.

Dial the phone number associated with the line to your **VT 9152**. While the greeting is playing, press **#**, followed by your 2 digit **security code**. You are now in **remote access** mode.

A voice menu will first tell you how many new and old messages you have, and then, after a pause, you will hear a review of the following remote commands:

### REMOTE COMMANDS

<b>#1</b>	<b>HELP MENU</b>
<b>#2</b>	<b>PLAY ALL MESSAGES</b>
<b>#4</b>	<b>REPEAT CURRENT MESSAGES</b>
<b>#4, #4</b>	<b>PLAY PREVIOUS MESSAGE</b>
<b>#5</b>	<b>STOP</b> (Playback or Recording)
<b>#6</b>	<b>SKIP TO NEXT MESSAGE</b>
<b>#7</b>	<b>REVIEW GREETING</b>
<b>#9</b>	<b>ERASE CURRENT MESSAGE</b>
<b>#0</b>	<b>ANSWERING SYSTEM ON/OFF</b>
<b>*7</b>	<b>RECORD GREETING</b>
<b>*8</b>	<b>RECORD MEMO</b>
<b>*0</b>	<b>HANG UP</b>

**NOTE:** You do not have to wait until the voice menu announces the command to execute a particular remote function.

# HEADSET OPERATION

Your **VT 9152** cordless telephone is equipped with a 2.5mm Headset Jack for use with an accessory Headset for hands-free operation.

Locate the Headset Jack on the **VT 9152** handset. Connect line plug on the Headset cord to the jack on the cordless Handset. The plug should in securely. Do not force the connection.

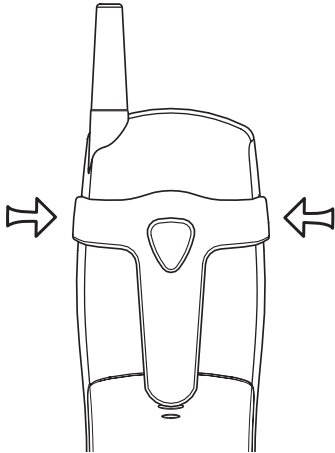

## BELT CLIP

- \* The **VT 9152** is also equipped with a detachable belt clip. Align the pins on the inside edge of the belt clip with the notches on the side of the **VT 9152** handset. The belt clip should snap securely into place. Do not force the connection. See Illustration.

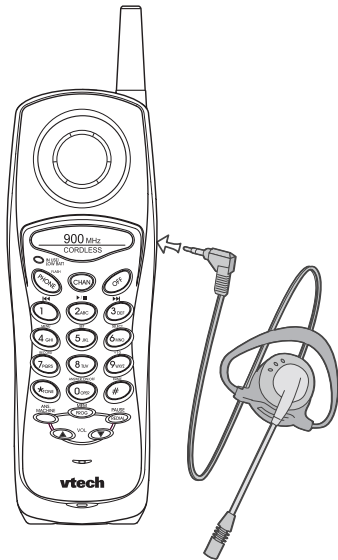

## OPERATION

**NOTE:** Whenever a compatible Headset is connected to the cordless Handset, the microphone on the Handset will be MUTED. This is done to limit the effect of background noise.

- \* The following operational characteristics apply to VTECH Headsets. the same may also apply to other (non-VTECH) compatible headsets, but VTECH assumes no responsibility for their performance.
- \* The VTECH brand compatible Headset has a monaural design which is reversible, so you can wear your Headset on either the left or right ear, leaving one ear free for room conversation.
- \* The headband can be adjusted to fit the contour of your head. Using both hands, slide the headband up or down so that it rests comfortably on your head with the speaker cushion centered against your ear.
- \* For maximum sound quality, the flexible microphone should be positioned at the corner of your mouth, about one inch from your mouth.

## IN CASE OF DIFFICULTY

---

If you have difficulty operating your phone, the suggestions below should solve the problem. If you still have difficulty after trying these suggestions,

In the US call:

**VTECH COMMUNICATIONS at 1-800-595-9511.**

In Canada call:

**VTECH ELECTRONICS at 1-800-267-7377.**

### THE PHONE DOESN'T WORK AT ALL.

- Make sure the power cord is plugged in.
- Make sure the telephone line cord is plugged firmly into the base unit and the telephone wall jack.
- Make sure the batteries are properly charged. If the **LOW BATT** indicator is slowly flashing, the battery needs charging.
- If you recently installed a new battery pack, make sure it is installed correctly.

### NO DIAL TONE.

- First check all the suggestions above.
- If you still don't hear a dial tone, disconnect the base unit from the telephone jack and connect a different phone. If there is no dial tone on that phone either, the problem is in your wiring or local service. Call your local telephone company.

### YOU GET NOISE, STATIC, OR A WEAK SIGNAL EVEN WHEN YOU'RE NEAR THE BASE UNIT.

- Place the handset in the base momentarily to re-set the unit. Then press **PHONE/FLASH** to get a line.
- Household appliances plugged into the same circuit as the base unit can sometimes cause interference. Try moving the appliance or the base unit to another outlet.

### YOU GET NOISE, STATIC, OR A WEAK SIGNAL WHEN YOU'RE AWAY FROM THE BASE UNIT.

- You may be out of range. Either move close to the base, or relocate the base unit.
- The layout of your home may be limiting the range. Try moving the base unit to the second or third floor, or to some other location.

### THE HANDSET DOES NOT RING WHEN YOU RECEIVE A CALL.

- Ensure that the ringer is turned on.
- Make sure the telephone line cord is plugged firmly into the base unit and the telephone jack. Make sure the power cord is plugged in.
- You may be too far from the base unit.
- You may have too many extension phones on your telephone line to allow all of them to ring. Try unplugging some of the other phones.

## IN CASE OF DIFFICULTY

---

### YOUR CALLER FADES IN AND OUT.

- You may be nearly out of range. Move closer, or relocate the base.

### YOU HEAR OTHER CALLS WHILE USING YOUR PHONE.

- Press **CHAN** key to switch to another channel.
- Disconnect your base unit from the telephone jack, and plug in a regular telephone. If you still hear other calls, the problem is probably in your wiring or local service. Call your local telephone company.

### YOU HEAR NOISE IN THE HANDSET, AND NONE OF THE KEYS OR BUTTONS WORK.

- Make sure the power cord is plugged in.
- Your base unit and handset may not be operating on the same channel. Place the handset in the cradle for a few moments to reset the channel.

### YOUR ANSWERING SYSTEM IS NOT RECORDING MESSAGES

- Make sure your Answering System is turned on. See **TURNING YOUR ANSWERING SYSTEM ON/OFF**.
- Your Answering System may be in **ANNOUNCE ONLY** mode. See **SET ANNOUNCE ONLY** for steps to return to normal (record messages) operation.

### THE *ANSWER ON/OFF* LIGHT ON THE BASE UNIT IS BLINKING

- This indicates that the **Day** and **Time** need to be set. See **SET DAY & TIME** for more information.

### COMMON CURE FOR ELECTRONIC EQUIPMENT

Electronics, like people, can sometimes get confused. If the unit does not seem to be responding normally, then try putting the handset in the cradle to re-initialize the unit. If it still does not seem to respond, perform the following steps (in the order listed):

1. Disconnect the power to the base.
2. Disconnect (remove) the handset battery.
3. Wait a few minutes.
4. Connect power to the base.
5. Install the handset battery pack.
6. Put the handset in the base to re-initialize. If the handset has not been recently charged, allow 16 hours before use.

# LIMITED WARRANTY STATEMENT

---

## What does this limited warranty cover?

- The manufacturer of this VTECH product, VTECH Communications, warrants to the holder of a valid proof of purchase ("Consumer" or "you") that the product and all accessories provided by VTECH in the sales package ("Product") are free from material defects in material and workmanship, pursuant to the following terms and conditions, when installed and used normally and in accordance with operation instructions. This limited warranty extends only to the Consumer for Products purchased and used in the United States of America.

## What will VTECH Communications do if the Product is not free from material defects in materials and workmanship during the limited warranty period ("Materially Defective Product")?

- During the limited warranty period, **VTECH's** authorized service representative will repair or replace, at **VTECH's** option, without charge, a Materially Defective Product. If we repair this product, we may use new or refurbished replacement parts. If we choose to replace this product, we may replace it with a new or refurbished product of the same or similar design. **VTECH** will return repaired or replacement products to you in working condition. **VTECH** will retain defective parts, modules, or equipment. Repair or replacement of Product, at **VTECH's** option, is your exclusive remedy. You should expect the repair or replacement to take approximately 30 days.

## How long is the limited warranty period?

- The limited warranty period for the product extends for ONE (1) YEAR from the date of purchase. If we repair or replace a Materially Defective Product under the terms of this limited warranty, this limited warranty also applies to repaired or replacement Products for a period of either (a) 90 days from the date the repaired or replacement Product is shipped to you or (b) the time remaining on the original one-year limited warranty, whichever is longer.

## What is not covered by this limited warranty?

This limited warranty does not cover:

1. Product that has been subjected to misuse, accident, shipping or other physical damage, improper installation, abnormal operation or handling, neglect, inundation, fire, water, or other liquid intrusion; or
2. Product that has been damaged due to repair, alteration, or modification by anyone other than an authorized service representative of VTECH; or
3. Product to the extent that the problem experienced is caused by signal conditions, network reliability or cable or antenna systems; or
4. Product to the extent that the problem is caused by use with non- VTECH electrical accessories; or
5. Product whose warranty/quality stickers, Product serial numbers plates or electronic serial numbers have been removed, altered or rendered illegible; or
6. Product purchased, used, serviced, or shipped for repair from outside the United States, or used for commercial or institutional purposes (including but not limited to Products used for rental purposes); or
7. Product returned without valid proof of purchase (see 6 below); or
8. Charges for installation or set up, adjustment of customer controls, and installation or repair of systems outside the unit.

# LIMITED WARRANTY STATEMENT

## How do you get warranty service?

- To obtain warranty service in the United States of America, call 1-800-595-9511 for instructions regarding where to return the Product. Before calling for service, please check the user's manual. A check of the Product controls and features may save you a service call.
- Except as provided by applicable law, you assume the risk of loss or damage during transit and transportation and are responsible for delivery or handling charges incurred in the transport of Product(s) to the service location. **VTECH** will return repaired or replaced Product under this limited warranty to you, transportation, delivery or handling charges prepaid. **VTECH** assumes no risk for damage or loss of the Product in transit.
- If the Product failure is not covered by this limited warranty, or proof of purchase does not meet the terms of this limited warranty, **VTECH** will notify you and will request that you authorize the cost of repair prior to any further repair activity. You must pay for the cost of repair and return shipping costs for the repair of Products that are not covered by this limited warranty.

## What must you return with the Product to get warranty service?

You must:

1. Return the entire original package and contents including the Product to the VTECH service location along with a description of the malfunction or difficulty;
2. Include "valid proof of purchase" (sales receipt) identifying the Product purchased (Product model) and the date of purchase or receipt; and
3. Provide your name, complete and correct mailing address, and telephone number.

## Other limitations

- This warranty is the complete and exclusive agreement between you and **VTECH**. It supersedes all other written or oral communications related to this Product. **VTECH** provides no other warranties for this product. The warranty exclusively describes all of **VTECH's** responsibilities regarding the product. There are no other express warranties. No one is authorized to make modifications to this limited warranty and you should not rely on any such modification.

**State Law Rights:** This warranty gives you specific legal rights, and you may also have other rights which vary from state to state.

**Limitations:** Implied warranties, including those of fitness for a particular purpose and merchantability (an unwritten warranty that the product is fit for ordinary use) are limited to one year from date of purchase. Some states do not allow limitations on how long an implied warranty lasts, so the above limitation may not apply to you.

- In no event shall VTECH be liable for any indirect, special, incidental, consequential, or similar damages (including, but not limited to lost profits or revenue, inability to use the product, or other associated equipment, the cost of substitute equipment, and claims by third parties) resulting from the use of this product. Some states do not allow the exclusion or limitation of incidental or consequential damages, so the above limitation or exclusion may not apply to you.

# FCC AND IC REGULATIONS

---

This equipment complies with FCC AND IC REGULATIONS 15 and 68 of the Federal Communications Commission (FCC) rules for the United States. It also complies with regulations RSS-210 and CS-03 of Industry Canada (IC).

A label is located on the underside of the base unit containing either the FCC registration number and Ringer Equivalence Number (REN) or the IC registration number and Load Number. You must, upon request, provide this information to your local telephone company. This equipment is compatible with inductively coupled hearing aids.

## FCC Part 15

**Warning:** Changes or modifications to this unit not expressly approved by the party responsible for compliance could void the user's authority to operate the equipment. The equipment has been tested and found to comply with part 15 of the FCC rules. These limits are designed to provide reasonable protection against harmful interference in a residential installation. This equipment generates, uses and can radiate radio frequency energy and, if not installed and used in accordance with the instructions, may cause harmful interference to radio communications. However, there is no guarantee that interference will not occur in a particular installation. If this equipment does cause harmful interference to radio or television reception, which can be determined by turning the equipment off and on, the user is encouraged to try and correct the interference by one or more of the following measures:

- Reorient or relocate the receiving antenna.
- Increase the separation between the equipment and receiver.
- Connect the equipment into an outlet or on a circuit different from that to which the receiver is connected.
- Consult the dealer or an experienced radio/TV technician for help.

## FCC Part 68

The FCC requires that you connect your cordless telephone to the nationwide telephone network through a modular telephone jack (USOC RJ11C or RJ11W).

Your telephone company may discontinue your service if your equipment causes harm to the telephone network. They will notify you in advance of disconnection, if possible. During notification, you will be informed of your right to file a complaint with the FCC.

If it is determined that your telephone equipment is malfunctioning, the FCC requires that it not be used and that it be unplugged from the modular jack until the problem has been corrected. Repairs to this telephone equipment can only be made by the manufacturer or its authorized agents or by others who may be authorized by the FCC. For repair procedures, follow the instructions outlined under the **VTECH** Limited Warranty.

The REN is useful in determining the number of devices you may connect to your telephone line and still enable the devices to ring when you receive a call. The general rule is that the REN value should not exceed 5.0 total; however, contact your local telephone company for the specific number in your area.

## IC (Industry Canada)

This telephone is registered for use in Canada.

**Notice:** The Industry Canada label identifies certified equipment. This certification means that the equipment meets certain telecommunications network, protective, operational and safety requirements. Industry Canada does not guarantee the equipment will operate to the user's satisfaction.

## FCC AND IC REGULATIONS

Before installing this equipment, users should ensure that it is permissible to be connected to the facilities of the local telecommunications company. The equipment must also be installed using an acceptable method of connections. The customer should be aware that compliance with the above conditions may not prevent degradation of service in situations.

Repairs to certified equipment should be made by an authorized Canadian maintenance facility designated by the supplier. Any repairs or alterations made by the user to this equipment, or equipment malfunctions, may give the telecommunications company cause to request the user to disconnect the equipment.

Users should ensure for their own protection that the electrical ground connections of the power utility, telephone lines and internal metallic water pipe system, if present, are connected together. This precaution may be particularly important in rural areas.

**Caution:** Users should not attempt to make such connections themselves, but should contact appropriate electric inspection authority, or electrician, as appropriate.

**Notice:** The REN assigned to this device denotes the number of devices you may connect to the telephone loop which is used by the device to prevent overloading. The termination on a loop may consist of any combination of devices subjected only to the requirement that the sum of the REN does not exceed five(5.0).

This device complies with RSS-210 of Industry Canada. Operation is subject to the following two conditions: (1) this device may not cause interference, and (2) this device must accept any interference, including interference that may cause undesired operation of the device.

### RBRC® Seal



The **RBRC®** Seal on the nickel-cadmium battery contained in our product indicates that VTECH Communications, Inc. is voluntarily participating in an industry program to collect and recycle these batteries at the end of their useful lives, when taken out of service within the United States and Canada. The **RBRC®** program provides a convenient alternative to placing used nickel-cadmium batteries into the trash or municipal waste, which may be illegal in your area.

VTECH's partnership with **RBRC®** makes it easy for you to drop off the spent battery at local retailers participating in the **RBRC®** program or at authorized VTECH product service centers. Please call **1-800-8-BATTERY** for information on Ni-Cd battery recycling and disposal bans/restrictions in your area. VTECH's involvement in this program is part of its commitment to protecting our environment and conserving natural resources.

**RBRC® is a registered trademark of Rechargeable Battery Recycling Corporation.**

# MAINTENANCE

---

## TAKING CARE OF YOUR TELEPHONE.

Your VT 9152 cordless telephone contains sophisticated electronic parts so it must be treated with care.

### Avoid rough treatment

Place the handset down gently. Save the original packing materials to protect your telephone if you ever need to ship it.

### Avoid Water

Your telephone can be damaged if it gets wet. Do not use the handset outdoors in the rain, or handle it with wet hands. Do not install your base unit near a sink, bathtub or shower.

Remember that electrical appliances can cause serious injury if used when you are wet or standing in water. If your base unit should fall into water, ***DO NOT RETRIEVE IT UNTIL YOU UNPLUG THE POWER CORD AND TELEPHONE LINE CORDS FROM THE WALL.*** Then pull the unit out by the unplugged cords.

### Electrical Storms

Electrical storms can sometimes cause power surges harmful to electronic equipment. For your own safety, use caution when using electric appliances during storms.

### Cleaning your telephone

Your telephone has a durable plastic casing that should retain its luster for many years. Clean it only with a soft cloth slightly dampened with water or a mild soap. Do not use excess water or cleaning solvents of any kind.

# TECHNICAL SPECIFICATIONS

---

## FREQUENCY CONTROL

Crystal Controlled Dual PLL Synthesizer

## TRANSMIT FREQUENCY

Handset: 923.10 MHz to 927.75 MHz

Base: 902.3 MHz to 906.65 MHz

## RECEIVE FREQUENCY

Handset: 902.3 MHz to 906.65 MHz

Base: 923.10 MHz to 927.75 MHz

## NOMINAL EFFECTIVE RANGE

Maximum power allowed by FCC and IC. Actual operating range may vary according to environmental conditions at the time of use.

## SIZE

Handset: 17.5cm x 5.5cm x 3.9cm

(L x W x T) maximum

(antenna excluded)

Base: 18.1cm x 12.5cm x 5.9cm

(L x W x T) maximum

(antenna excluded)

## WEIGHT

Handset: 130 grams

Base: 310 grams

(battery pack excluded)

## POWER REQUIREMENTS

Handset: Self-contained nickel-cadmium rechargeable battery supply, 3.6V nominal, 400mAh capacity.

Power Adapter: 9V DC @ 400mA

**SPECIFICATIONS ARE TYPICAL AND MAY CHANGE WITHOUT NOTICE.**



---

**vtech**

**VTECH TELECOMMUNICATIONS LTD.**



A member of THE VTECH GROUP OF COMPANIES.

Distributed in the U.S.A. by VTech Communications Inc, Beaverton, Oregon, 97008

Distributed in the Canada by VTech Electronics Canada Ltd., Suite 200-7671 Alderbridge Way Richmond, B.C. V6X 1Z9.

Copyright 2001 for VTECH TELECOMMUNICATIONS LTD.  
Printed in China

91-5244-10-00  
ISSUED 0