



## TABLE OF CONTENTS

<b>IMPORTANT SAFETY INSTRUCTIONS .....</b>	<b>3</b>
<b>PARTS CHECK LIST.....</b>	<b>4</b>
<b>HANDSET LAYOUT .....</b>	<b>5</b>
<b>BASE UNIT LAYOUT .....</b>	<b>6</b>
<b>GETTING STARTED .....</b>	<b>7</b>
<b>INSTALLATION OF BATTERY PACK IN HANDSET .....</b>	<b>7</b>
<b>RINGER SELECTION.....</b>	<b>8</b>
<b>tone/PULSE SELECTION .....</b>	<b>8</b>
<b>ANSWERING SYSTEM - INTRODUCTION .....</b>	<b>8</b>
<b>THE HANDSET DISPLAY .....</b>	<b>9</b>
<b>BASIC OPERATION .....</b>	<b>10</b>
<b>MAKING CALLS .....</b>	<b>10</b>
<b>VOLUME CONTROL .....</b>	<b>11</b>
<b>CHANNEL CHANGING .....</b>	<b>11</b>
<b>USING REDIAL .....</b>	<b>12</b>
<b>ANSWERING CALLS .....</b>	<b>12</b>
<b>FLASH .....</b>	<b>12</b>
<b>HOLD .....</b>	<b>13</b>
<b>PAGE .....</b>	<b>13</b>
<b>ADVANCED OPERATION .....</b>	<b>14</b>
<b>CALLER ID/CALL WAITING ID .....</b>	<b>14</b>
<b>RECEIVING AND STORING CALLS .....</b>	<b>14</b>
<b>ABOUT CALL HISTORY .....</b>	<b>14</b>
<b>REVIEW CALLER ID .....</b>	<b>14</b>
<b>DELETING RECORDS FROM CALL HISTORY .....</b>	<b>15</b>
<b>DIAL A DISPLAYED NUMBER .....</b>	<b>15</b>
<b>STORE A CALLED ID RECORD IN PHONE BOOK MEMORY .....</b>	<b>15</b>
<b>DISPLAY SCREEN MESSAGES .....</b>	<b>16</b>
<b>PHONE BOOK .....</b>	<b>17</b>
<b>STORE MEMORY NUMBERS .....</b>	<b>17</b>
<b>EDIT NUMBERS STORED IN MEMORY .....</b>	<b>18</b>
<b>DELETE NUMBERS STORED IN MEMORY .....</b>	<b>18</b>
<b>DIAL MEMORY NUMBERS .....</b>	<b>18</b>
<b>OPTIONAL HEADSET INSTALLATION &amp; OPERATION INSTRUCTIONS .....</b>	<b>19</b>
<b>ITAD OPERATION .....</b>	<b>20</b>
<b>ANSWERING SYSTEM PROGRAMMING OVERVIEW .....</b>	<b>20</b>
<b>SET OUTGOING MESSAGE (OGM) .....</b>	<b>20</b>
<b>SET SECURITY CODE .....</b>	<b>21</b>
<b>DAY AND TIME .....</b>	<b>22</b>
<b>SET AUDIBLE MESSAGE ALERT .....</b>	<b>22</b>
<b>SET ANNOUNCE ONLY .....</b>	<b>23</b>
<b>SET BASE RINGER ON/OFF .....</b>	<b>23</b>
<b>SET NUMBER OF RINGS .....</b>	<b>23</b>
<b>TOLL SAVER .....</b>	<b>23</b>
<b>LEAVING A MESSAGE (INCOMING MESSAGE) .....</b>	<b>24</b>
<b>LISTENING TO MESSAGES/MEMOS .....</b>	<b>24</b>
<b>SAVING MESSAGES .....</b>	<b>25</b>
<b>DELETING MESSAGES .....</b>	<b>25</b>
<b>TURNING THE ANSWERING MACHINE ON/OFF .....</b>	<b>25</b>
<b>CHECKING AND SETTING DAY ANDTIME .....</b>	<b>26</b>
<b>CHANGING SPEAKER VOLUME .....</b>	<b>26</b>
<b>CHANGING PLAYBACK SPEED .....</b>	<b>26</b>



## TABLE OF CONTENTS

AUTO DISCONNECT FOR EXTENSION PHONE PICK-UP .....	27
MEMORY FULL .....	27
POWER FAILURE .....	27
BASE UNIT MESSAGE WINDOW (LED) .....	28
REMOTE OPERATION OF ANSWERING SYSTEM .....	29
TO ACTIVATE REMOTE OPERATION FROM A DIFFERENT TELEPHONE LINE .....	29
PLAYING MESSAGES REMOTELY .....	29
REPEAT MESSAGES DURING PLAYBACK .....	29
SKIP MESSAGES DURING PLAYBACK .....	30
STOP MESSAGE PLAYBACK .....	30
DELETING MESSAGES .....	30
MEMO RECORDING .....	30
CHANGE OGM REMOTELY .....	30
CHECK OGM REMOTELY .....	30
TURNING ANSWERING SYSTEM ON OR OFF .....	30
VOICE MENU FOR REMOTE OPERATION .....	31
EXITING REMOTE OPERATION .....	31
<b>ADDITIONAL INFORMATION .....</b>	<b>32</b>
MAINTENANCE .....	32
IN CASE OF DIFFICULTY .....	33
WARRANTY STATEMENT .....	35
FCC AND IC REGULATIONS .....	37
RBRC® SEAL .....	40
TECHNICAL SPECIFICATIONS .....	41



## **IMPORTANT SAFETY INSTRUCTIONS**

When using your telephone equipment, basic safety precautions should always be followed to reduce the risk of fire, electric shock and injury, including the following:

1. Read and understand all instructions.
2. Follow all warnings and instructions marked on the product.
3. Unplug this product from the wall outlet before cleaning. Do not use liquid cleaners or aerosol cleaners. Use a damp cloth for cleaning.
4. Do not use this product near water (for example, near a bath tub, kitchen sink, or swimming pool).
5. Do not place this product on an unstable cart, stand, or table. The product may fall, causing serious damage to the product.
6. Slots and openings in the cabinet and the back or bottom are provided for ventilation. To protect it from overheating, these openings must not be blocked by placing the product on the bed, sofa, rug, or other similar surface. This product should never be placed near or over a radiator or heat register. This product should not be placed in a built-in installation where proper ventilation is not provided.
7. This product should be operated only from the type of power source indicated on the marking label. If you are not sure of the type of power supply to your home, consult your dealer or local power company.
8. Do not allow anything to rest on the power cord. Do not locate this product where the cord will be abused by persons walking on it.
9. Never push objects of any kind into this product through cabinet slots as they may touch dangerous voltage points or short out parts that could result in a risk of fire or electric shock. Never spill liquid of any kind on the product.
10. To reduce the risk of electric shock, do not disassemble this product. If service or repair work is required, contact VTECH Customer Service at 1-800-595-9511. Opening or removing cabinet parts other than specified access doors may expose you to dangerous voltages or other risks. Incorrect reassembling can cause electric shock when the appliance is subsequently used.
11. Do not overload wall outlets and extension cords as this can result in the risk of fire or electric shock.
12. Unplug this product from the wall outlet :
  - A. When the power supply cord or plug is damaged or frayed.
  - B. If liquid has been spilled into the product.
  - C. If the product has been exposed to rain or water.
  - D. If the product does not operate normally by the following the operating instructions. Adjust only those controls that are covered by the operating instructions because improper adjustment of other controls may result in damage and will often require extensive work to restore the product to normal operation.
  - E. If the product has been dropped and the cabinet has been damaged.
  - F. If the product exhibits a distinct change in performance.
13. Avoid using a telephone (other than a cordless type) during an electrical storm. There may be a remote risk of electric shock from lightning.
14. Do not use the telephone to report a gas leak in the vicinity of the leak.

## **SAVE THESE INSTRUCTIONS**



## PARTS CHECK LIST

### Parts Check List:

- |                   |                        |
|-------------------|------------------------|
| 1. Base Unit      | 4. Telephone Line Cord |
| 2. Handset        | 5. AC Adaptor          |
| 3. Owner's Manual | 6. Battery Pack        |

To purchase replacement battery packs, call VTECH Communications at 1-800-595-9511. In Canada, call VTECH Telecommunications Canada Ltd. at 1-800-267-7377.

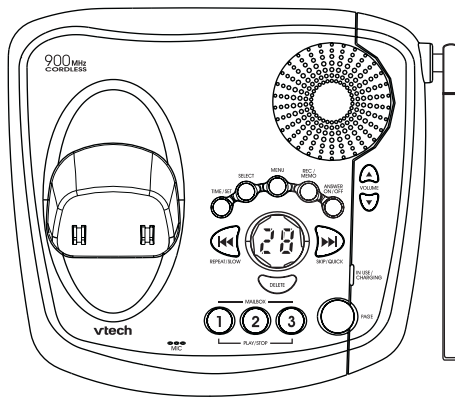

Base Unit



Handset

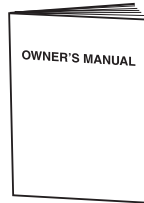

Owner's Manual

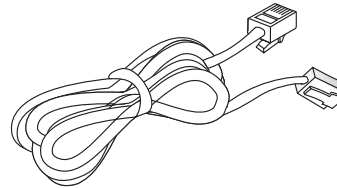

Telephone Line Cord

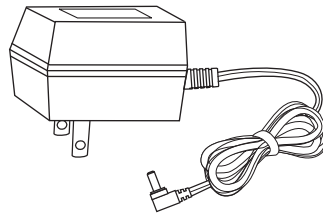

AC Adaptor

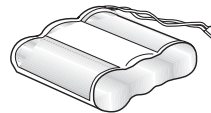

Battery Pack



## HANDSET LAYOUT

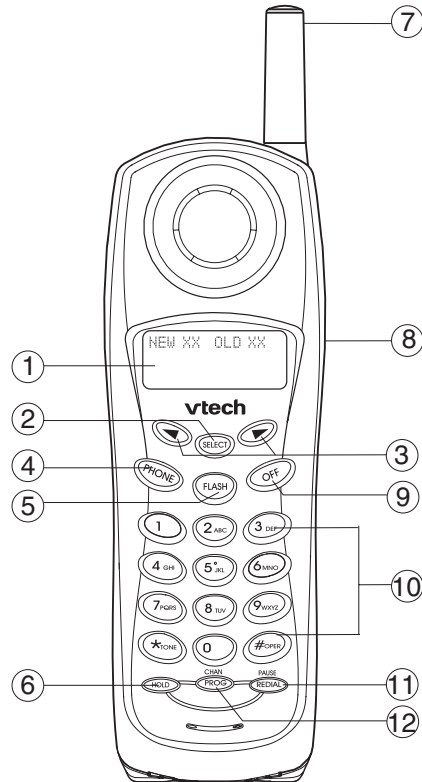

- |                                  |                         |
|----------------------------------|-------------------------|
| <b>1.</b> LCD Display            | <b>8.</b> Headset Jack  |
| <b>2.</b> SELECT                 | <b>9.</b> OFF           |
| <b>3.</b> NAVIGATION/Volume Keys | <b>10.</b> Dialing Keys |
| <b>4.</b> PHONE                  | <b>11.</b> REDIAL/PAUSE |
| <b>5.</b> FLASH                  | <b>12.</b> PROG/CHAN    |
| <b>6.</b> HOLD                   |                         |
| <b>7.</b> Antenna                |                         |



## BASE UNIT LAYOUT

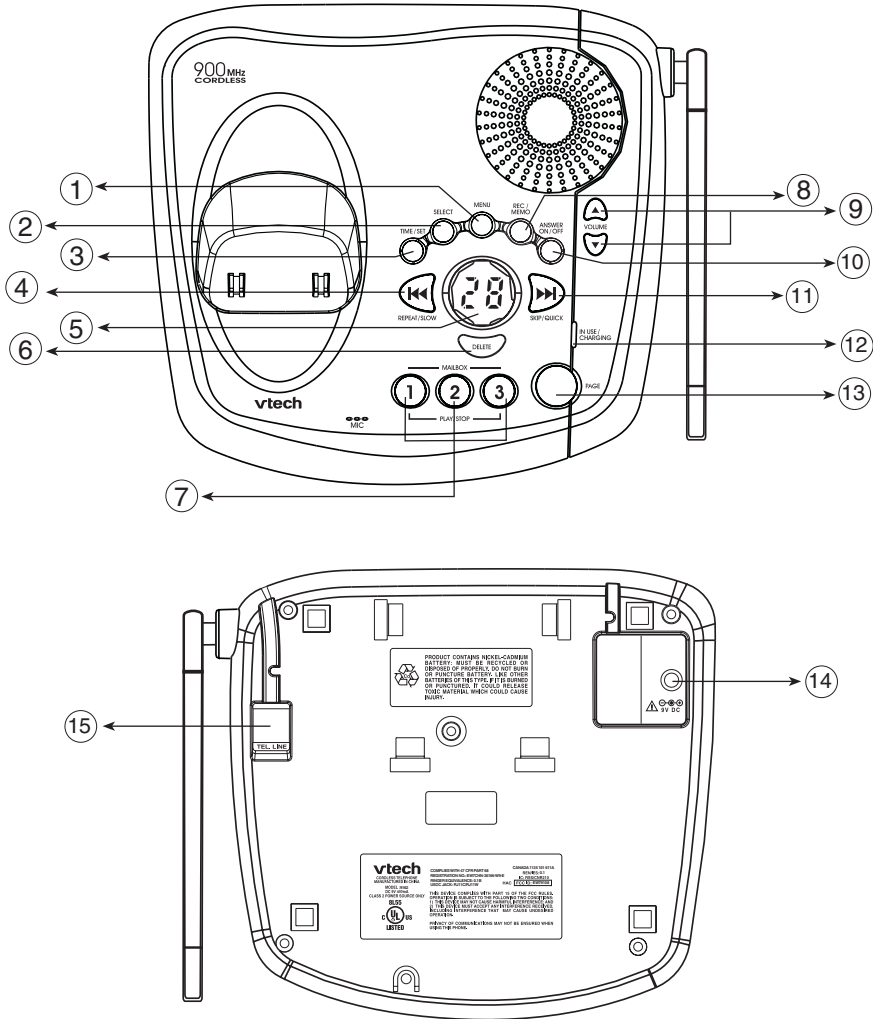

1. MENU
2. SELECT
3. TIME/SET
4. REPEAT/SLOW
5. MESSAGE WINDOW
6. DELETE
7. MAILBOX PLAY/STOP
8. REC/MEMO

9. VOLUME
10. ANSWER ON/OFF
11. SKIP/QUICK
12. IN USE/CHARGING
13. PAGE
14. Power Jack
15. Telephone Line Jack





## INSTALLATION OF BATTERY PACK IN HANDSET

The Handset of your **VT 9162** is powered by a rechargeable battery pack. It charges automatically whenever the Handset is in the Base Unit. The battery pack needs charging when:

- The low battery icon and message are displayed:
- A double beep will be generated every 5 seconds.



To charge the battery pack, place the Handset in the Base Unit. The **IN USE/CHARGING** indicator will light to show the Handset is seated properly and the battery pack is charging. It is recommended that the battery pack should be charged for at least 16 hours initially. Afterwards, 8 hours of maintenance charging should be sufficient.

To replace the battery pack, follow the steps below:

1. Remove the battery case cover by pressing on the ridged lines and sliding downward.
2. Discard the old battery pack by pulling firmly on the battery cords. Don't put the old battery pack in a trash compactor or a fire - it could burst. Please recycle.
3. Snap in the new battery pack, with the wires in the lower left corner. Insert the battery plug into the socket, aligning the two holes in the plug with the socket pins.
4. Place the cord in the case so it rests below the battery pack.

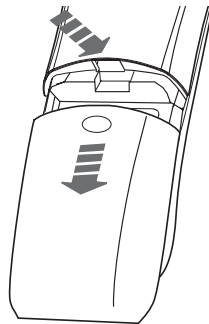

5. Replace the battery case cover by sliding the cover upwards.
6. Place the Handset in the cradle of the Base Unit to allow it to charge for 16 hours.

**CAUTION: To Reduce the Risk of Fire or Injury, Read and Follow the Instructions**

### IMPORTANT:

Do not dispose of this battery pack into household garbage. For information on recycling or proper disposal, consult your local solid waste collection or disposal organization.

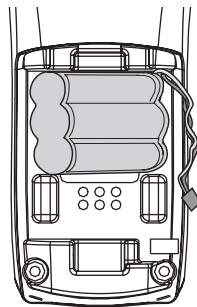

1. Use only VTech rechargeable battery pack, or equivalent.
2. Do not dispose of the battery pack in a fire. The cell may explode.
3. Do not open or mutilate the battery pack. Released electrolyte is corrosive and may cause damage to the eyes or skin. It may be toxic if swallowed.
4. Exercise care in handling batteries in order not to short the battery with conducting materials such as rings, bracelets, and keys. The battery pack or conductor may overheat and cause burns.

To purchase replacement battery packs, call VTech at 1-800-595-9511.



## SETTING UP YOUR VT9162

When fully charged, you will experience up to **5** hours of continuous talk, or up to **6** days of standby (off the cradle, but not in use).

### RINGER SELECTION

1. Press **PROG/CHAN**.
2. Press **▼** or **▼** until **RINGER** is displayed.
3. Press **SELECT**. The current setting is blinks.
4. Press **▼** or **▼** to select a different ring style (there are 4), or turn the ringer **OFF**.
5. Press **SELECT** to confirm your choice.



RINGER: 1

**NOTE:** If the ringer is set to OFF, the display will show "RINGER OFF" in idle mode.

### STONE/PULSE SELECTION

**NOTE:** Your **VT 9162** is factory-preset for **STONE** dialing.

1. To change dialing mode, press **PROG/CHAN**,
2. Press **▼** or **▼** until **DIAL MODE** is displayed.
3. Press **SELECT**. The current setting is blinks.
4. Press **▼** or **▼** to change the setting.
5. Press **SELECT** to confirm your choice.



DIAL MODE: STONE

### ANSWERING SYSTEM - INTRODUCTION

Your **VT9162** includes a digital answering system in the Base Unit. Setup of the answering system is easy. Step by step instructions can be found in the section entitled **Answering System Setup**, later on in this user's manual.



## THE HANDSET DISPLAY

### If the display says:

NEW 01 OLD 03

\*\* RINGING \*\*

CONNECTING...

PHONE

\*\* PAGING \*\*

HOLD

BATTERY LOW

### It means:

The Handset is in idle mode

Indicates incoming call

Waiting for dial tone

Handset is in use

The base is page the handset.

**There is a call on hold.**

**The battery need to be charged.**



## BASIC OPERATION

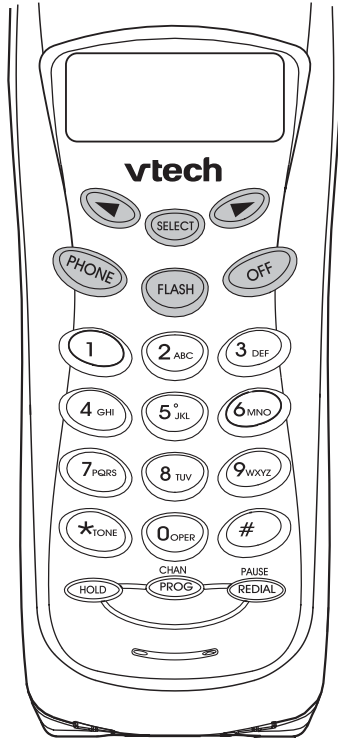

### MAKING CALLS

#### Method 1-----Live Dialing

Press **PHONE**. Dial the phone number.



Press **OFF** to end your call.



#### Method 2-----Pre-dialing

Dial the phone number. Use the  key to backspace if you make a dialing mistake. Then press **PHONE**.

Press **OFF** to end your call.

When the handset is in use, the **IN USE/CHARGING** light on the Base Unit will flash. When the Handset is in the Base Unit cradle, the **IN USE/CHARGING** light glows steadily.



## BASIC OPERATION

### VOLUME CONTROL

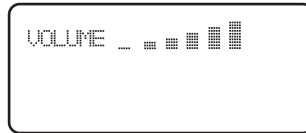
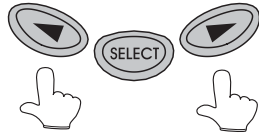

While you are on a call, press ▲ to raise the inbound volume and ▼ to lower it. The handset will display the relative volume setting as you adjust it.

### CHANNEL CHANGING



If you experience noise or interference while on a call, you may be too far from the Base Unit, or in an obstructed area. Try moving to a different location. If this does not improve the transmission, press **PROG/CHAN**. You can press this key more than once, if necessary.

**NOTE:** This feature only operates while you are on an active call.



**BASIC OPERATION**



## BASIC OPERATION

### USING REDIAL



1. Press **PHONE**. Listen for dial tone.
2. Press **REDIAL/PAUSE**. The last number you called will automatically be redialed.

**OR**

1. Press **REDIAL**. The number will appear on the display.
2. Press **PHONE**.

**NOTE:** If you press **REDIAL** twice, the redial number will be deleted.

### ANSWERING CALLS

To answer a call, press **any** key other than the **OFF** key.

During an incoming call, to temporarily mute the ringing, press **OFF**.  
(Note: This feature is not available when the Handset is in its cradle.)

### FLASH



When you receive a *Call Waiting* alert, press **FLASH** to switch to the incoming call.

Press **FLASH** again to return to the first call.



## BASIC OPERATION



### HOLD

To place your call on hold, press **HOLD**. Press **HOLD** again to return to your call.



**NOTE:** If you have a call on hold, and pick up a parallel extension phone, your **VT 9162** will automatically drop the call and return to idle mode.

### PAGE

The Base can signal the Handset by means of the **PAGE** key. This is helpful in locating a misplaced Handset. Press **PAGE** at the Base. The Handset will generate a series of tones (different than inbound call ringing) for a maximum of **60** seconds, and will display:

Press **PAGE** at the Base or **OFF** key on the Handset to end the Page.

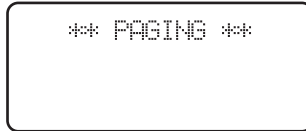

## CALLER ID/CALL WAITING ID

**NOTE:** Caller ID and Call Waiting ID are subscription services, provided by your regional phone company. You must subscribe to these services in order to benefit from the Caller ID features of your **VT 9162**. Contact your regional phone service provider for details.

### RECEIVING AND STORING CALLS

As new Caller ID/Call Waiting ID records are received, **NEW** followed by the number of new Caller ID records received will be displayed on the Handset.

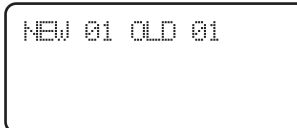

Your **VT 9162** will store the most current **50** Caller ID and Call Waiting ID records. To review Caller ID records, press **▼** while the Handset is in the idle mode. Keep pressing **▼** to scroll through more records.

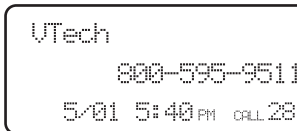

### ABOUT CALL HISTORY

This phone assigns each incoming call a number from 1 to 50. The most recent call will have the highest number. When the memory is full, the oldest call information is deleted to make room for new incoming call information.

For each call that comes in, the screen displays the following information between the first and second rings:

- Your caller's name (15 letters are sent by your telephone company);
- The caller's area code and telephone number;
- The time and date of the call; and
- The position of the call in call history.

If you answer a call before the information appears on the screen, it will not be in the call history.

**Note:** Press **OFF** at any time to exit Caller ID review mode.

### REVIEW CALLER ID

The screen displays call information for about 15 seconds after it has been received.

1. Press **▼** to view Caller ID.
2. Use **▼** and **▲** to scroll through records in call history.



## CALLER ID /CALL WAITING ID

### DELETING RECORDS FROM CALL HISTORY

#### DELETE A SPECIFIC CALL

1. Locate the record you want to delete from call history.
2. Press **SELECT**, then press  $\blacktriangledown$  until **ERASE** flashes.
3. Press **SELECT**. The screen displays **ERASE NO YES ALL** and the phone number. The current choice flashes.
4. Press  $\blacktriangledown$  until **YES** flashes.
5. Press **SELECT**. You'll hear a series of beeps confirming the deletion.

```

DIAL PGM ERASE
800-595-9511
5/01 5:40PM OLD28

```

#### DELETE ALL CALLS

1. While viewing call history, press **SELECT**, then press  $\blacktriangledown$  until **ERASE** flashes.
2. Press **SELECT**. The screen displays **ERASE NO YES ALL** and the phone number. The current choice flashes.
3. Press  $\blacktriangledown$  until **ALL** flashes, then press **SELECT**. The screen displays **ERASE ALL NO YES**. The current choice flashes.
4. Press  $\blacktriangledown$  until **YES** flashes.
5. Press **SELECT**. You will hear a series of beeps confirming the deletion.

```

DIAL PGM ERASE
800-595-9511
5/01 5:40PM OLD28

```

**Note :** You can only delete all calls if all caller ID records have been previously viewed.

### DIAL A DISPLAYED NUMBER

1. Locate the record in call history that you want to dial.
2. If you wish to change how the number is dialed, press **#**. Pressing **#** repeatedly will display all alternate dialing sequences available for this call (area code + number; 1+ area code + number; 1+ number; number only).
3. Press **SELECT**. **DIAL** will be flashing.
4. Press **SELECT** again. The number will be dialed.

```

DIAL PGM ERASE
800-595-9511
5/01 5:40PM OLD28

```

### STORE A CALLER ID RECORD IN PHONE BOOK MEMORY

1. Use the  $\blacktriangledown$  key to locate the desired CID record.
2. If you wish to change how the number is stored, press **#**. Pressing **#** repeatedly will display all alternate dialing sequence available for this call (area code + number; 1+ area code + number; 1+ number; number only).
3. Press **SELECT**, then press  $\blacktriangledown$  until **PGM** flashes.
4. Press **SELECT**. You can now edit the **NAME** if you wish. Press  $\blacktriangledown$  to backspace in order to edit the name.

```

DIAL PGM ERASE
800-595-9511
5/01 5:40PM OLD28

```



## CALLER ID/CALL WAITING ID

5. Press **SELECT**. You can now edit the PHONE NUMBER. Press **▼** to backspace in order to edit the phone number.
6. Press **SELECT**. Your CID record is now in your Phone Book directory.

## DISPLAY SCREEN MESSAGES

Screen Display:	When:
<b>BLOCKED NAME</b>	The other party is blocking name information.
<b>BLOCKED CALL</b>	The other party is blocking name and number information.
<b>UNKNOWN NAME</b>	Your phone company is unable to receive information about this caller's name.
<b>UNKNOWN CALLER</b>	Your phone company is unable to receive information about this caller's name and number.
<b>Err</b>	There is a problem with Caller ID transmission from the telephone company.



## PHONE BOOK

This cordless phone can store 20 telephone numbers with names, each up to 16 digits long. Entries are stored alphabetically. For consistency with Caller ID entries, you may wish to enter last names first.

**Note:** Press **OFF** at any time to exit memory.

### STORE MEMORY NUMBERS

1. Press **PROG/CHAN**. The screen displays **DIRECTORY**.
2. Press **SELECT**. The screen displays **ENTER NAME**.
3. Using the chart below, enter up to 15 characters for the name you're storing with the number. Use **▼** to backspace and make corrections; use **▼** to advance and add a space.

Dial Key	Presses					
	1	2	3	4	5	6
1	1					
2	A	B	C	2		
3	D	E	F	3		
4	G	H	I	4		
5	J	K	L	5		
6	M	N	O	6		
7	P	Q	R	S	7	
8	T	U	V	8		
9	W	X	Y	Z	9	
0	0					
*	*					
#	&	'	,	-	.	#

4. When you finish entering the name, press **SELECT**. The screen displays **ENTER NUMBER**.
5. Enter the telephone number. Use **▼** to backspace and make a correction. Press **REDIAL/PAUSE** to store a pause in the dialing sequence.
6. Press **SELECT** to store your entry. The screen displays **SAVING...** and you'll hear a series of beeps confirming the entry.

**Note:** When memory is full the screen displays **MEMORY FULL**, an error tone sounds, and you will not be able to store a new number until you delete a stored number.



## PHONE BOOK

### EDIT NUMBERS STORED IN MEMORY

1. Press **▼**. The screen displays **DIRECTORY**.
2. Press **▲** or **▼** to scroll alphabetically through numbers stored in memory  
**-OR-**  
Press the dial pad key for the first letter of the entry you want to edit.
3. When the screen displays the number you want to edit, press **SELECT**. Then press **▼** until **EDIT** flashes.
4. Press **SELECT**. The screen displays the name and number. The flashing cursor appears at the end of the name. Use **▲**, **▼** and the dial pad keys to edit the name. Press **SELECT** to move on to edit the number.
5. Press **SELECT** to save the edited information. You'll hear a series of beeps confirming the change.

DIAL EDIT ERASE  
800-595-9511

### DELETE NUMBERS STORED IN MEMORY

1. Press **▼**. The screen displays **DIRECTORY**.
2. Press **▲** or **▼** to scroll alphabetically through numbers stored in memory  
**-OR-**  
Press the dial pad key for the first letter of the entry you want to delete.
3. When the screen displays the number you want to delete, press **SELECT**. Then press **▼** until **ERASE** flashes.
4. Press **SELECT**. The screen displays **ERASE NO YES** and the number. The current choice flashes.
5. Press **▼** until **YES** flashes.
6. Press **SELECT**. You'll hear a series of beeps confirming the deletion.

DIAL EDIT ERASE  
800-595-9511

### DIAL MEMORY NUMBERS

1. Press **▼**. The screen displays **DIRECTORY**.
2. Press **▲** or **▼** to scroll alphabetically through numbers stored in memory,  
**-OR-**  
Press the dial pad key for the first letter of the entry you want to dial.
3. When the screen displays the number you want to dial, press **SELECT**. Then press **▲** or **▼** until **DIAL** flashing.
4. Press **SELECT**, The phone automatically dials the number.

DIAL EDIT ERASE  
800-595-9511



## OPTIONAL HEADSET INSTALLATION & OPERATING INSTRUCTIONS

Your **VT 9162** cordless telephone is equipped with a 2.5mm Headset Jack for use with an **optional** accessory Headset for hands-free operation.



If you choose to use the Headset option, you must do the following:

### INSTALLATION

- \* Obtain an optional accessory Head set, which is compatible with the **VT 9162**.

Please contact **VTECH Communications Customer Service**, in the U.S. toll-free at **1-800-595-9511**, in Canada call **1-800-267-7377** for dealer information in your local area. You can also purchase a compatible Headset directly from VTECH Communications Customer Service.

- \* Once you have a compatible 2.5mm Headset, locate the Headset Jack on the Handset of your **VT 9162**. Connect the plug on the Headset to the jack on the cordless Handset. The plug should fit securely. Do not force the connection. See illustration.

### OPERATION

**NOTE:** Whenever a compatible Headset is connected to the cordless Handset, the microphone on the Handset will be **MUTED**. This is done to limit the effect of background noise.

- \* Many compatible Headsets have a monaural design which is reversible, so you can wear your Headset on either the left or right ear, leaving one ear free for room conversation.



## ANSWERING SYSTEM SETUP

### Answering System Programming Overview

Setup order for the Answering System is:

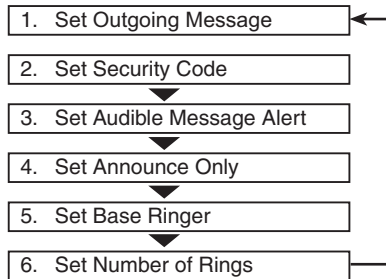

During Answering System setup, the display will flash "--". If no key is pressed for 20 seconds, the Answering System will beep, and exit program mode. You can also exit program mode at any time by pressing any **MAILBOX** key.

### Set Outgoing Message (OGM)

Selecting Announcement

There are 2 choices of announcements:

Normal outgoing message & Outgoing message for Announce Only.

#### 1. Normal answering mode (Announce Only: OFF)

In this mode, the caller is able to leave his message. If no announcement is recorded, the default announcement "Hello, I'm unable to answer your call right now. Please leave your name, number and message after the tone." will be used. Your **VT9162** is preset at the factory to this mode (Announce Only: OFF).

#### 2. Announce Only mode

If this mode is set, the caller is not able to leave his message. If no announcement is recorded, the factory default greeting is: "Hello, I'm unable to answer your call right now. Please call again. Thank you." will be used.

#### Example for OGM1 (for multi - user application);

"Hi! We can't come to the phone right now. If you have a message for John press 1, for Jane press 2, for Jack press 3, Or just stay on the line and record after the beep. Thank you."

#### Example for OGM2 (Announce Only):

"Hi! You have reached Jack and Jill. We will be back after 1 p.m. Please call back then. Thank you."



## ANSWERING SYSTEM SETUP

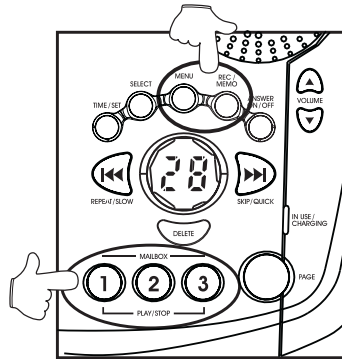

### NOTE:

In Announce Only mode, your outgoing announcement is repeated before hanging up.

### Recording / Playing / Deleting the Outgoing Messages (OGM)

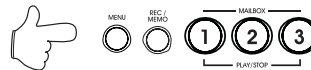

1. Press **MENU** until the desired item (Set Outgoing Message) is announced.

2. Press **REC/MEMO**, "Now recording", is announced, followed by a beep. Speak towards the front of the Answering System (**max. length: 90 seconds**).
3. Press any **MAILBOX** key to stop the recording.
4. Your outgoing message is played for you, followed by a beep.
5. To review a recorded announcement, press **MENU** key until "Set Outgoing Message" is announced. Press any **MAILBOX** key. The current greeting is played.
6. To delete a recorded announcement, press **DELETE** during OGM playback. You then hear "Outgoing Message has been erased".

### NOTE:

If your recording time is less than 2 seconds, your OGM will not be recorded, and the default greeting will be used.

### Set Security Code

The security code programmed into the Answering System is used to gain access to functions from remote locations. The security code default setting is 50. You can select any two-digit code, from 40 to 99.

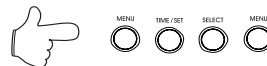
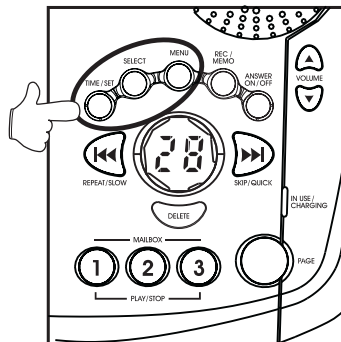

1. Press **MENU** until you hear "Set security code."
2. Press **TIME/SET** to hear the current security code.
3. Press **SELECT** briefly to increase the security code by 1. Or, hold **SELECT** continuously to increase the code by multiples of 10.
4. Press **TIME/SET** to confirm your choice and you will hear the announcement of the security code.

## ANSWERING SYSTEM SETUP

### Set Audible Message Alert

If you want your Answering System to beep once every 10 seconds to notify you when new messages have been received, set Audible Message Alert to ON. Otherwise, it is preset to OFF.

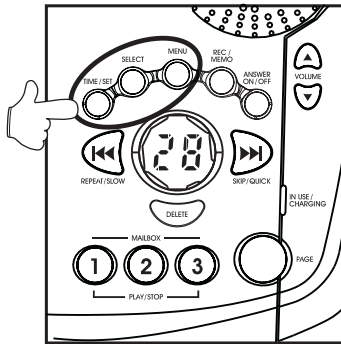

1. Press **MENU** until you hear "Set Audible Message Alert."
2. Press **SELECT** until the desired setting, (ON or OFF) is announced.
3. Press **TIME/SET** to confirm your choice. The voice prompt of "Audible Message Alert is On" or "Audible Message Alert is Off" will be heard.



## ANSWERING SYSTEM SETUP

### Set Announce Only

**CAUTION:**

If you turn on the Announce Only option, your callers cannot leave a message.

1. Press **MENU** until "Set Announce Only" is announced.
2. Press **SELECT** until desired setting "ON" or "OFF" is declared.
3. Press **TIME/SET** to confirm, and the setting will be announced.

**Note:** You can store one OGM for Announce Only mode, and a separate OGM for Normal (accept messages) mode. The appropriate OGM will be played based on how you set Announce Only.

### Set Base Ringer On/Off

The Base ringer can be turned on or off.

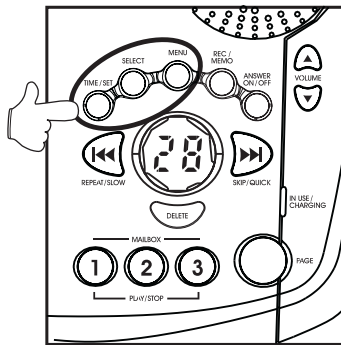

1. Press **MENU** until you hear "Set Base Ringer"
2. Press **SELECT** to toggle between the choices (ON or OFF).
3. Press **TIME/SET** to confirm your selection. Voice prompt of "Base Ringer is on" or "Base Ringer is off" will be announced to confirm your setting.

### Set Number of Rings

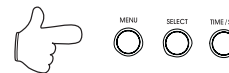

The Answering System has 4 ring type settings:

- 2 rings** The incoming call is answered after 2 rings.
- 4 rings** The incoming call is answered after 4 rings.
- 6 rings** The incoming call is answered after 6 rings.

### Toll Saver

The incoming call is answered after 2 rings only if there are new messages/memos present. Otherwise, the call is answered after 4 rings. This may help you avoid long distance charges when retrieving messages remotely.

1. Press **MENU** until you hear "Set number of rings."
2. Press **SELECT** until you hear the desired setting "2", "4", "6", or "Toll Saver".
3. Press **TIME/SET** to confirm your choice. The selected setting is then announced.

## ANSWERING SYSTEM OPERATIONS

### Leaving a Message (Incoming Message)

The Answering System will answer a call (according to the current ring selection), then play the OGM, followed by a beep to signal the start of recording.

- Default mailbox is MAILBOX 1.
- If you want to record the incoming message in specific mailbox, press "x" during OGM playback.
- After desired mailbox is selected, "Mailbox X, now recording" will be announced, and incoming message recording starts after a beep.
- If incoming message length is less than 2 seconds, message will not be recorded.  
**An incoming message can be a maximum of 4 minutes.**
- \* To record a MEMO at the Base Unit, press **REC/MEMO**, you are prompted to choose a mailbox. Then, press the desired **MAILBOX** key and, after the beep, speak towards the front of the Base. Press any **MAILBOX** key when finished.

### Listening to Messages / Memos

When any messages and/or memos are left, the system will display the total number of messages in all mailboxes.

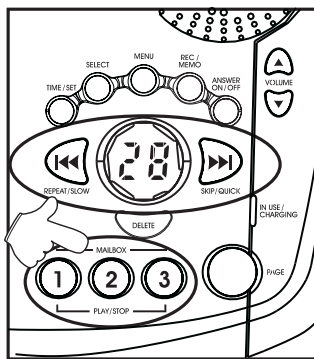

- Press the desired Mailbox key to hear messages.
- The system will announce "Mailbox X, you have x new message(s) and x old message(s)" in the presence of new messages in the corresponding mailbox. Then the system will play only the new messages.
- In the absence of new messages, the system will announce "Mailbox x, you have x old messages" and then playback the old messages.
- The **»»** and **««** keys can be used to skip forward and backward during message playback.
- To stop message playback, and return to normal operation mode, press any MAILBOX key.
- The day and time stamp is announced before each message is played.
- After all messages and memos have been played, the final voice prompt will be, "End of messages", and the Answering System will exit playback mode.
- Note that the system will play the messages on a "First-In-First-Out" basis.
- If the system has less than 5 minutes recording time left, it will announce the remaining recording time to alert the user.
- During message playback, the display will be flashing to indicate that the currently playing message is a new message.

## ANSWERING SYSTEM OPERATIONS

### Saving Messages

- The Answering System will automatically save your messages if you do not delete them. The messages will be retained even after a power failure.
- The system can record up to 15 minutes of messages.

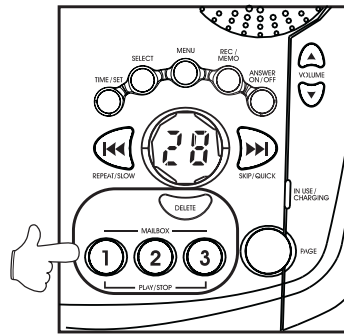

### Deleting Messages



Press **DELETE** at any time during message playback to delete the current message.

All old messages for a particular mailbox can be deleted by pressing the **DELETE** key. The system will announce "Please select mailbox".

Press the **Mailbox X** key to delete all the old messages in the selected mailbox.

### NOTE:

The **DELETE** function will only delete old messages. New messages **CANNOT** be deleted until they are reviewed.

### Turning the Answering Machine ON/OFF

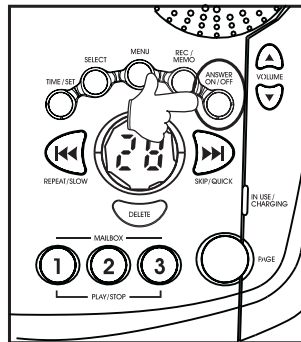

- If you want the Answering System to answer calls, press **ANSWER ON/OFF**. The backlit LED will then be turned on, and "Answering machine on" will be announced.
- If you don't want the Answering System to answer calls, press **ANSWER ON/OFF**. The backlit LED will then be turned off and "Answering machine off" will be announced.
- The display will still show the number of messages.
- Even if the Answering System is set to OFF, it will still answer calls after 10 rings. An announcement, "Please enter your security code" is given, and you can enter your security code to use remote operation. (See **Remote Operation of Answering System**)

## ANSWERING SYSTEM OPERATIONS

### Checking and Setting Day and Time

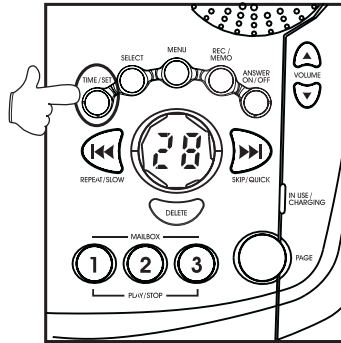

- Press **TIME/SET**. The system announces the clock setting then announces; "To Set Date and Time, press **TIME/SET**."
- Press **TIME/SET**.
- Press **SELECT** until hear the correct day; then press **TIME/SET**.
- Press **SELECT** until hear the correct hour; then press **TIME/SET**.
- Press **SELECT** until hear the correct minute; then press **TIME/SET**. The system announces the current clock setting.

### Changing Speaker Volume

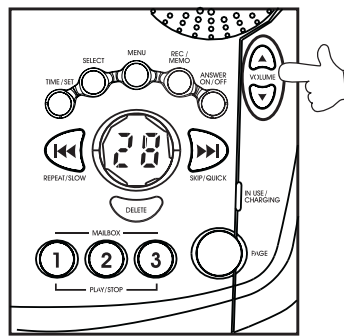

If you prefer to not hear messages while your callers leave them (call screening), set the volume to the minimum level (1). Press the ▲ and ▼ keys for the desired volume level. There are 8 volume levels. If volume is set at maximum or minimum level, Further pressing of the volume keys will give 3 short beep tones. Volume changes continuously if the Volume UP or DOWN key is held.

### Changing Playback Speed

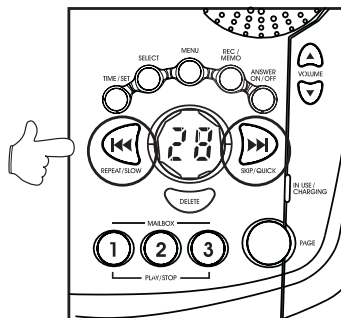

During playback, you can change the playback speed by simply holding down ◀◀ (SLOW) or ▶▶ (QUICK) to the desired speed during playback. There are 3 playback speeds (SLOW/NORMAL/QUICK). The default speed is normal. Playback speed will return to normal once you release the ▶▶ or ◀◀ Key.



## ANSWERING SYSTEM OPERATIONS

### Auto Disconnect for Extension Phone Pick-up

The Answering System will auto-disconnect the telephone line if an extension phone or the cordless Handset accesses the line.

### Memory Full

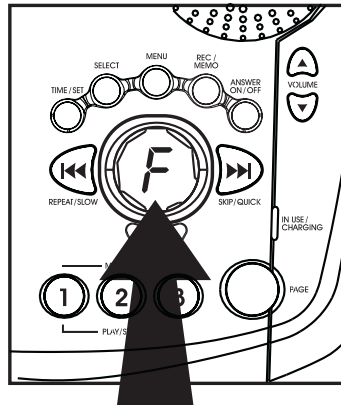

- When the Answering System has less than 30 seconds recording time remaining, or the total number of messages equal 99, the display shows "F" with the number of messages to indicate memory full.
- If the Answering System memory is full, it will automatically default to Answering System OFF mode. The Answering System will answer a call after 10 rings and "Memory full, Please enter your security code" is announced. You may enter remote operation mode by entering the security code.
- If memory is full, any attempt to record memos or OGM's will be ignored.

### Power Failure

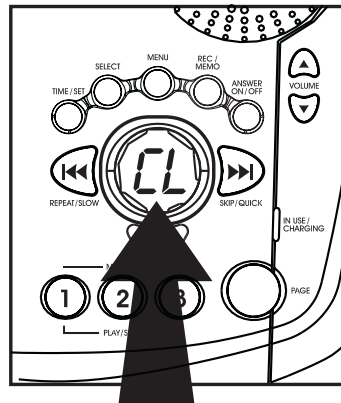

- After a power failure, "CL" will flash to notify you to set the day and time.
- All the messages, OGM's and menu settings (other than day and time) will be retained.
- The Answering System will default to ANSWER ON.
- Note that after power up, the Answering System may have an initialization period, during which, the display will flash with "--". During this period, you can still use the cordless phone.



## ANSWERING SYSTEM OPERATIONS

### BASE UNIT MESSAGE WINDOW (LED)

- The large Base Unit LED provides useful data on the status of your **VT 9162** answering device. Below are examples of the LED data:

The LED displays:	What it means
1-99	Total number of messages in all mailboxes, or current message number during playback.
0	You have no messages
CL flashing	The clock needs to be set
A	Answering System is in Announce-Only mode
F flashing	Answering System memory is full
99 flashing	Recording time has exceeded 99 seconds
1-8	Volume level as you're setting it.
---	Answering System is answering a call or in remote mode
--- flashing	Answering System is in programming mode





## REMOTE OPERATION OF ANSWERING SYSTEM

Remote operation allows you to control the functions of the Answering System when you are away from the Base, and call from an outside telephone line. The Answering System cannot be accessed from another telephone on the same line. You can access many of the Answering System functions from a remote location, such as listening to messages, changing recorded announcements, and recording memos.

Remote operation can only be accessed from a touch tone telephone. If the remote phone is set to pulse dialing, switch it tone. If tone dialing is not available, you will not be able to access the Answering System.

**Note:** All function codes should be entered within 2 seconds in order to activate Remote Operation.

### To Activate Remote Operation From a Different Telephone Line

1. If the Answering System is **OFF**, you can dial your telephone number and wait for the Answering System to answer your call after 10 rings. An announcement, "Please enter your security code" is given, and you enter your security code to use remote operation.
2. If the Answering System is **ON**, it will answer your call and begin playing the currently selected announcement (as with any incoming call).
3. Enter your 2 digit security code during the announcement. The default security code is 50.
4. Once the security code is received, a double confirmation beep will be given, and you are in Remote Operation mode. You can then control the Answering Machine functions using the telephone keypad.
5. The user can also enter the Remote Operation mode during message recording. The procedure is the same as step 3. The recording will be stopped after entering the valid security code "xx" and the incomplete message will be deleted. If " \* 0" is entered, the Answering System will release the line, but the recorded message will still be retained.
6. If the user enters a wrong security code, the system will not release the line.

### Playing Messages Remotely

1. Press " #1 ", " #2 " or " #3 " on the touch tone keypad to play the messages in the corresponding mailbox.
2. The system will announce "Mailbox X. You have XX new messages and XX old messages" and the system will playback the new messages only. If there are no new messages, the system will announce "Mailbox X. You have XX old messages. On the other hand, in the absence of old messages, the system will announce only the number of new messages.

### Repeat Messages During Playback

1. Press "#4" once during message playback to repeat the current message.
2. Press "#4" twice within 2 seconds to skip to the previous message.

## REMOTE OPERATION OF ANSWERING SYSTEM

### Skip Messages During Playback

1. Press **"#6"** once to skip forward to the next message.

### Stop Message Playback

1. Pressing **"#5"** during message playback will stop playback.

### Deleting Messages

1. Press **"#9"** once during message playback to delete the current message.

**Note:** Playback will pause if **"#"** or **"\*"** is entered. Answering System will wait for the command in the following 2 seconds. If no further tone is entered, playback will be resumed.

### Memo Recording

1. Press **"\*8"**, "Please select mailbox " will be announced.
2. After selecting the mailbox by entering command **"1"**, **"2"**, **"3"**, You will hear, "Now recording", followed by a beep.
3. Enter **"#5"** to stop recording when you have finished.

### Change OGM Remotely

1. Enter **"\*7"** to record a new OGM. You will hear, "Now recording", followed by a beep to signal start of recording.
2. Press **"#5"** to stop recording. Your new OGM will playback automatically.

### Check OGM Remotely

Enter **"#7"** to review OGM. You will hear playback of OGM followed by a beep.

### Turning Answering System ON or OFF

Pressing **"#0"** toggles the Answering System **ON/OFF**. "Answering machine on", or "Answering machine off" will be announced, followed by a beep.



## REMOTE OPERATION OF ANSWERING SYSTEM

### Voice Menu for Remote Operation

The system provides two pre-recorded voice menus to help you during remote operation. Press "**\* 5**", and you will hear the simple voice menu.

The simple voice menu is as follows:

Press "**# 1**" to play mailbox 1.  
Press "**# 2**" to play mailbox 2.  
Press "**# 3**" to play mailbox 3.  
Press "**# 5**" to stop.  
Press "**# 4**" to repeat the message.  
Press "**# 6**" to skip the message.  
Press "**# 9**" to erase the message.  
Press "**\* 5**" for other functions.  
(To the advanced voice menu)  
The advanced voice menu is as follows:  
Press "**# 7**" to review outgoing message.  
Press "**\* 7**" to record outgoing message.  
Press "**\* 8**" to record memo.  
Press "**# 4**" twice to repeat previous message.  
Press "**# 0**" to turn the system on or off.  
Press "**\* 5**" for other function.

Pressing any function code will stop the voice menu, and perform the corresponding function.

### Exiting Remote Operation

1. Enter "**\* 0**" on the touch tone keypad to exit remote operation mode. The Answering System confirms your action with a long beep and then disconnects.
2. The Answering System also automatically disconnects if no key is pressed within 20 seconds during remote operation.



## MAINTENANCE

### Taking Care Of Your Telephone

Your cordless telephone contains sophisticated electronic parts, so it must be treated with care.

#### Avoid rough treatment

Place the Handset down gently. Save the original packing materials to protect your telephone if you ever need to ship it.

#### Avoid water

Your telephone can be damaged if it gets wet. Do not use the Handset outdoors in the rain, or handle it with wet hands. Do not install your Base Unit near a sink, bathtub or shower.

#### Electrical storms

Electrical storms can sometimes cause power surges harmful to electronic equipment.

For your own safety, use caution when using electric appliances during storms.

#### Cleaning your telephone

Your telephone has a durable plastic casing that should retain its luster for many years. Clean it only with a soft cloth slightly dampened with water or a mild soap. Do not use excess water or cleaning solvents of any kind.

Remember that electrical appliances can cause serious injury if used when you are wet or standing in water. If your Base Unit should fall into water, **DO NOT RETRIEVE IT UNTIL YOU UNPLUG THE POWER CORD AND TELEPHONE LINE CORDS FROM THE WALL.** Then pull the unit out by the unplugged cords.



## IN CASE OF DIFFICULTY

If you have difficulty operating your phone, the suggestions below should solve the problem. If you still have difficulty after trying these suggestions,

In the US call:  
**VTECH COMMUNICATIONS at 1-800-595-9511.**

In Canada call:  
**VTECH TELECOMMUNICATIONS CANADA LTD. at 1-800-267-7377.**

### THE PHONE DOESN'T WORK AT ALL.

- Make sure the power cord is plugged in.
- Make sure the telephone line cord is plugged firmly into the base unit and the telephone wall jack.
- Make sure the batteries are properly charged. If the Battery Low indicator is on, the battery needs charging. If the LCD display shows **"NEEDS RECHARGING"**: you must charge the batteries.
- If you recently installed a new battery pack, make sure it is installed correctly.

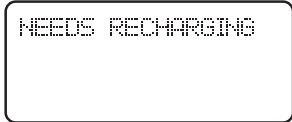

### NO DIAL TONE.

- First check all the suggestions above.
- If you still don't hear a dial tone, disconnect the base unit from the telephone jack and connect a different phone. If there is no dial tone on that phone either, the problem is in your wiring or local service. Call your local telephone company.



### YOU GET NOISE, STATIC, OR A WEAK SIGNAL EVEN WHEN YOU'RE NEAR THE BASE UNIT.

- Place the handset in the base momentarily to re-set the unit. Then press PHONE to get a line.
- Household appliances plugged into the same circuit as the base unit can sometimes cause interference. Try moving the appliance or the base unit to another outlet.

### YOU GET NOISE, STATIC, OR A WEAK SIGNAL WHEN YOU'RE AWAY FROM THE BASE UNIT.

- You may be out of range. Either move close to the base, or relocate the base unit.
- The layout of your home may be limiting the range. Try moving the base unit to the second or third floor, or to some other location.





## IN CASE OF DIFFICULTY

### THE HANDSET DOES NOT RING WHEN YOU RECEIVE A CALL.

- Ensure that the ringer is turned on.
- Make sure the telephone line cord is plugged firmly into the base unit and the telephone jack. Make sure the power cord is plugged in.
- You may be too far from the base unit.
- You may have too many extension phones on your telephone line to allow all of them to ring. Try unplugging some of the other phones.

### YOUR CALLER FADES IN AND OUT.

- You may be nearly out of range. Move closer, or relocate the base.

### YOU HEAR OTHER CALLS WHILE USING YOUR PHONE.

- Press **CHAN** key to switch to another channel.
- Disconnect your base unit from the telephone jack, and plug in a regular telephone. If you still hear other calls, the problem is probably in your wiring or local service. Call your local telephone company.

### YOU HEAR NOISE IN THE HANDSET, AND NONE OF THE KEYS OR BUTTONS WORK.

- Make sure the power cord is plugged in.
- Your base unit and handset may not be operating on the same channel. Place the handset in the cradle for a few moments to reset the channel.

### COMMON CURE FOR ELECTRONIC EQUIPMENT

Electronics, like people, can sometimes get confused. If the unit does not seem to be responding normally, then try putting the handset in the cradle to re-initialize the unit. If it still does not seem to respond, perform the following steps (in the order listed):

1. Disconnect the power to the base.
2. Disconnect (remove) the handset battery.
3. Wait a few minutes.
4. Connect power to the base.
5. Install the handset battery pack.
6. Put the handset in the base to re-initialize. If the handset has not been recently charged, allow 16 hours before use.

### 'CL' IS FLASHING ON THE BASE MESSAGE WINDOW.

- \* An interruption of power to the Base Unit caused the clock to require resetting. See **Answering System Setup - "Day and Time"**.

### THE ANSWERING SYSTEM IS NOT TAKING MESSAGES.

- \* Make sure the **ANSWER ON/OFF** key on the Base Unit is glowing red. If not, press it. You will hear "Answering Machine On".
- \* Make sure Announce Only is set to **OFF**. See **Answering System Setup - "Set Announce Only"**.



## WARRANTY STATEMENT

### What does this limited warranty cover?

- The manufacturer of this VTECH product, VTECH Communications, warrants to the holder of a valid proof of purchase ("Consumer" or "you") that the product and all accessories provided by VTECH in the sales package ("Product") are free from material defects in material and workmanship, pursuant to the following terms and conditions, when installed and used normally and in accordance with operation instructions. This limited warranty extends only to the Consumer for Products purchased and used in the United States of America.

### What will VTECH Communications do if the Product is not free from material defects in materials and workmanship during the limited warranty period ("Materially Defective Product")?

- During the limited warranty period, VTECH's authorized service representative will repair or replace, at VTECH's option, without charge, a Materially Defective Product. If we repair this product, we may use new or refurbished replacement parts. If we choose to replace this product, we may replace it with a new or refurbished product of the same or similar design. VTECH will return repaired or replacement products to you in working condition. VTECH will retain defective parts, modules, or equipment. Repair or replacement of Product, at VTECH's option, is your exclusive remedy. You should expect the repair or replacement to take approximately 30 days.

### How long is the limited warranty period?

- The limited warranty period for the product extends for ONE (1) YEAR from the date of purchase. If we repair or replace a Materially Defective Product under the terms of this limited warranty, this limited warranty also applies to repaired or replacement Products for a period of either (a) 90 days from the date the repaired or replacement Product is shipped to you or (b) the time remaining on the original one-year limited warranty, whichever is longer.

### What is not covered by this limited warranty?

This limited warranty does not cover:

- Product that has been subjected to misuse, accident, shipping or other physical damage, improper installation, abnormal operation or handling, neglect, inundation, fire, water, or other liquid intrusion; or
- Product that has been damaged due to repair, alteration, or modification by anyone other than an authorized service representative of VTECH; or
- Product to the extent that the problem experienced is caused by signal conditions, network reliability or cable or antenna systems; or
- Product to the extent that the problem is caused by use with non- VTECH electrical accessories; or
- Product whose warranty/quality stickers, Product serial numbers plates or electronic serial numbers have been removed, altered or rendered illegible; or
- Product purchased, used, serviced, or shipped for repair from outside the United States, or used for commercial or institutional purposes (including but not limited to Products used for rental purposes); or
- Product returned without valid proof of purchase (see 2 below); or
- Charges for installation or set up, adjustment of customer controls, and installation or repair of systems outside the unit.



ADDITIONAL INFORMATION





## WARRANTY STATEMENT

### How do you get warranty service?

- To obtain warranty service in the United States of America, call 1-800-595-9511 for instructions regarding where to return the Product. Before calling for service, please check the user's manual. A check of the Product controls and features may save you a service call.
- Except as provided by applicable law, you assume the risk of loss or damage during transit and transportation and are responsible for delivery or handling charges incurred in the transport of Product(s) to the service location. **VTECH** will return repaired or replaced Product under this limited warranty to you, transportation, delivery or handling charges prepaid. **VTECH** assumes no risk for damage or loss of the Product in transit.
- If the Product failure is not covered by this limited warranty, or proof of purchase does not meet the terms of this limited warranty, **VTECH** will notify you and will request that you authorize the cost of repair prior to any further repair activity. You must pay for the cost of repair and return shipping costs for the repair of Products that are not covered by this limited warranty.

### What must you return with the Product to get warranty service?

You must:

1. Return the entire original package and contents including the Product to the VTECH service location along with a description of the malfunction or difficulty;
2. Include "valid proof of purchase" (sales receipt) identifying the Product purchased (Product model) and the date of purchase or receipt; and
3. Provide your name, complete and correct mailing address, and telephone number.

### Other limitations

- This warranty is the complete and exclusive agreement between you and **VTECH**. It supersedes all other written or oral communications related to this Product. **VTECH** provides no other warranties for this product. The warranty exclusively describes all of **VTECH's** responsibilities regarding the product.  
There are no other express warranties. No one is authorized to make modifications to this limited warranty and you should not rely on any such modification.

**State Law Rights:** This warranty gives you specific legal rights, and you may also have other rights which vary from state to state.

**Limitations:** Implied warranties, including those of fitness for a particular purpose and merchantability (an unwritten warranty that the product is fit for ordinary use) are limited to one year from date of purchase. Some states do not allow limitations on how long an implied warranty lasts, so the above limitation may not apply to you.

- In no event shall VTECH be liable for any indirect, special, incidental, consequential, or similar damages (including, but not limited to lost profits or revenue, inability to use the product, or other associated equipment, the cost of substitute equipment, and claims by third parties) resulting from the use of this product. Some states do not allow the exclusion or limitation of incidental or consequential damages, so the above limitation or exclusion may not apply to you.



## FCC AND IC REGULATIONS

This equipment complies with Parts 15 of the Federal Communications Commission (FCC) rules for the United States. It also complies with regulations RSS210 and CS-03 of Industry and Science Canada. Operation is subject to the following two conditions: (1) this device may not cause interference, and (2) this device must accept any interference, including interference that may cause undesired operation of the device.

A label is located on the underside of the Base Unit containing either the FCC registration number and Ringer Equivalence Number (REN) or the IC registration number and Load Number. You must, upon request, provide this information to your local telephone company.

This equipment is compatible with inductively coupled hearing aids.

Should you experience trouble with this telephone equipment, please contact:

### **VTech Communications Inc.**

SERVICE DEPT. at 1-800-595-9511. In Canada, call VTECH Telecommunications Canada Ltd. at 1-800-267-7377.

For repair/warranty information. The telephone company may ask you to disconnect this equipment from the line network until the problem has been corrected.

### **FCC Part 15**

Warning: Changes or modifications to this unit not expressly approved by the party responsible for compliance could void the user's authority to operate the equipment.

The equipment has been tested and found to comply with part 15 of the FCC rules. These limits are designed to provide reasonable protection against harmful interference in a residential installation. This equipment generates, uses and can radiate radio frequency energy and, if not installed and used in accordance with the instructions, may cause harmful interference to radio communications. However, there is no guarantee that interference will not occur in a particular installation. If this equipment does cause harmful interference to radio or television reception, which can be determined by turning the equipment off and on, the user is encouraged to try and correct the interference by one or more of the following measures:

- Reorient or relocate the receiving antenna.
- Increase the separation between the equipment and receiver.
- Connect the equipment into an outlet or on a circuit different from that to which the receiver is connected.
- Consult the dealer or an experienced radio/TV technician for help.





## FCC AND IC REGULATIONS

### FCC and ACTA Information

If this equipment was approved for connection to the telephone network prior to July 23,2001. It was registered with the Federal Commissions (FCC) in accordance with Part 68 of its rules. the equipment was approved after that date, it complies with the Part 68 rules and with Technical Requirements for Connection of Equipment to the Telephone Network adopted by the Administrative Council for Terminal Attachments (ACTA). We are required to provide you with the following information.

#### 1. Connection and use with the nationwide telephone network

The plug and jack used to connect this equipmet to the premises wiring and the telephone network must comply with the applicable Part 68 rules and technical requirements adopted by ACTA. A compliant telephone cord and modular plug is provided with this product. It is designed to be connected to a compatible modular jack that is also compliant. An RJ11 jack should normally be used for connecting to a single line and an RJ14 jack for two lines. See Installation Instructions in the user's manual. This equipment may not be used with Coin Telephone Lines or with Party Lines.

#### 2. Product identifier and REN information

The label on the back or bottom of this equipment contains, among other things, an identifier indicating product approval and the Ringer Equivalence Number (REN). This information must be provided to your local telephone company upon request. For equipment approved prior to July 23,2001, the product identifier is preceded by the phrase "FCC Reg No." and the REN is listed separately. For equipment approved after that date, the product identifier is preceded by "US" and a colon (:), and the REN is encoded in the product identifier as the sixth and seventh characters following the colon. For example, the product identifier US:AAAEQ03T123XYZ would indicate an REN of 0.3.

The REN is used to determine how many devices you may connect to your telephone line and still have them ring when you are called. In most , but not all areas, the sum of all RENS should be five (5.0) or less. You may want to connect your local telephone company for more information.

#### 3. Repair instructions

If the equipment is malfunctioning, it must be unplugged from the modular jack until the problem has been corrected. Repairs to this telephone equipment can only be made by the manufacturer or its authorized agents. For repair procedures, follow the instructions outlined under the Limited Warranty.

#### 4. Rights of the telephone company

If this equipment is causing harm to the telephone network, the telephone company may temporarily discontinue your telephone service. The telephone company is required to notify you before interrupting service. If advance notice is not practical, you will be notified as soon as possible. You will be given the opportunity to correct the problem and the telephone company is required to inform you of your right to file a complaint with the FCC. Your telephone company may make changes in facilities, equipment, operation, or procedures that could affect the proper functioning of this product. The telephone company is required to notify you if such changes are planned.

#### 5. Hearing aid compatibility

If this product is equipped with a corded or cordless handset, it is hearing aid compatible.

#### 6. Programming/testing of emergency numbers

If this product has memory dialing locations, you may choose to store police, fire department and emergency medical service telephone number in this locations. If you do, please keep three things in mind:



## FCC AND IC REGULATIONS

- a. We recommend that you also write the telephone number on the directory card, so that you can still dial the emergency number manually if the memory dialing feature doesn't work.
- b. This feature is provided only as a convenience, and the manufacturer assumes no responsibility for customer reliance upon the memory feature.
- c. Testing the emergency telephone numbers you have stored is not recommended. However, if you do make a call to an emergency number:
  - You must remain on the line and briefly explain the reason for the call before hanging up.
  - Programming/testing of emergency numbers should be performed during off-peak hours, such as in the early morning or late evening, when the emergency services tend to be less busy.

### IC (Industry Canada)

**This telephone is registered for use in Canada.**

**Notice :**

The REN assigned to this device denotes the number of devices you may connect to the telephone loop which is used by the device to prevent overloading. The termination on a loop may consist of any combination of devices subjected only to the requirement that the sum of the REN does not exceed five (5.0)

**Notice :**

The Industry Canada label identifies certified equipment. This certification means that the equipment meets certain telecommunications network protective, operational and safety requirements. The Department does not guarantee the equipment will operate to the user's satisfaction.

Before installing this equipment, users should ensure that it is permissible to be connected to the facilities of the local telecommunications company. The equipment must also be installed using an acceptable method of connection. The customer should be aware that compliance with the above conditions may not prevent degradation of services in some situations.

Repairs to certified equipment should be made by an authorized Canadian maintenance facility designated by the supplier. Any repairs or alterations made by the user to this equipment, or equipment malfunctions, may give the telecommunications company cause to request the user to disconnect the equipment.





## FCC AND IC REGULATIONS

Users should ensure for their own protection that the electrical ground connections of the power utility, telephone lines and internal metallic water pipe system, if present, are connected together. This precaution may be particularly important in rural areas.

### Caution :

Users should not attempt to make such connections themselves, but should contact the appropriate electrical inspection authority, or electrician, as appropriate.

Your cordless phone is designed to operate at the maximum power allowed by the FCC and IC. This means your Handset and Base Unit can communicate only over a certain distance - which will depend on the location of the Base Unit and Handset, weather, and the construction and layout of your home or office.

## RBRC® Seal



The **RBRC®** Seal on the nickel-cadmium battery contained in our product indicates that VTECH Communications, Inc. is voluntarily participating in an industry program to collect and recycle these batteries at the end of their useful lives, when taken out of service within the United States and Canada.

The **RBRC®** program provides a convenient alternative to placing used nickel-cadmium batteries into the trash or municipal waste, which may be illegal in your

area.

VTECH's partnership with **RBRC®** makes it easy for you to drop off the spent battery at local retailers participating in the **RBRC®** program or at authorized VTECH product service centers. Please call **1-800-8-BATTERY** for information on Ni-Cd battery recycling and disposal bans/restrictions in your area. VTECH's involvement in this program is part of its commitment to protecting our environment and conserving natural resources.

**RBRC® is a registered trademark of Rechargeable Battery Recycling Corporation.**



## TECHNICAL SPECIFICATIONS

### FREQUENCY CONTROL

Crystal Controlled Dual PLL Synthesizer

### TRANSMIT FREQUENCY

Handset: 923.40 MHz to 927.75 MHz  
(All 30 channels within this range)

Base: 902.40 MHz to 907.05 MHz  
(All 30 channels within this range)

### RECEIVE FREQUENCY

Handset: 902.40 MHz to 907.05 MHz  
(All 30 channels within this range)

Base: 923.40 MHz to 927.75 MHz  
(All 30 channels within this range)

### NOMINAL EFFECTIVE RANGE

Maximum power allowed by FCC and IC.  
Actual operating range may vary according to environmental conditions at the time of use.

### SIZE

Handset: 56(l) x 37(w) x 205(H)mm  
(L x W x T) maximum  
(antenna excluded)

Base: 165(L) x 135(W) x 50(H)mm  
(L x W x T) maximum  
(antenna excluded)

### WEIGHT

Handset: 160 grams

Base Unit: 210 grams

### POWER REQUIREMENTS

Handset: Self-contained nickel-cadmium rechargeable battery pack, 3.6V nominal, 400mAh capacity.

Base unit: 9V DC @400mA

### MEMORY

Phone Book: 20 Memory locations  
16 digits and 15 characters per location

CID: Alphanumeric Display  
50 Memory locations.

**SPECIFICATIONS ARE TYPICAL AND MAY CHANGE WITHOUT NOTICE.**



ADDITIONAL INFORMATION





**vtech**

**VTECH TELECOMMUNICATIONS LTD.**

A member of THE VTECH GROUP OF COMPANIES.

Distributed in the U.S.A. by VTech Communications Inc.; Beaverton, OR, 97008

Distributed in Canada by VTech Telecommunications Canada Ltd.; Suite 200,7671  
Alderbridge Way, Richmond, B.C. V6X 1Z9.

Copyright 2002 for VTECH TELECOMMUNICATIONS LTD.  
Printed in China

91-005820-0B0-000  
ISSUED 0

