

Important Safety Instructions

When using your telephone equipment, basic safety precautions should always be followed to reduce the risk of fire, electric shock and injury, including the following:

1. Read and understand all instructions.
2. Follow all warnings and instructions marked on the product.
3. Unplug this product from the wall outlet before cleaning. Do not use liquid or aerosol cleaners. Use a damp cloth for cleaning.
4. Do not use this product near water (for example, near a bath tub, kitchen sink or swimming pool).
5. Do not place this product on an unstable surface, such as a table, shelf or stand. The product may fall, causing serious damage.
6. Slots and openings in the back or bottom of the base unit and handset are provided for ventilation. To protect them from overheating, these openings must not be blocked by placing the product on a soft surface such as a bed, sofa or rug. This product should never be placed near or over a radiator or heat register. This product should not be placed in any area where proper ventilation is not provided.
7. This product should be operated only from the type of power source indicated on the marking label. If you are not sure of the type of power supply in your home, consult your dealer or local power company.
8. Do not allow anything to rest on the power cord. Do not install this product where the cord may have anyone walking on it.
9. Never push objects of any kind into this product through slots in the base or handset as they may touch dangerous voltage points or short out parts that could result in a risk of fire or electric shock. Never spill liquid of any kind on the product.
10. To reduce the risk of electric shock, do not disassemble this product, but take it to an authorized service facility. Opening or removing parts of the base or handset other than specified access doors may expose you to dangerous voltages or other risks. Incorrect reassembling can cause electric shock when the product is subsequently used.
11. Do not overload wall outlets and extension cords as this can result in the risk of fire or electric shock.
12. Unplug this product from the wall outlet and refer servicing to an authorized service facility under the following conditions:
 - A. When the power supply cord or plug is damaged or frayed.
 - B. If liquid has been spilled onto the product.
 - C. If the product has been exposed to rain or water.
 - D. If the product does not operate normally by following the operating instructions. Adjust only those controls that are covered by the operating instructions, as improper adjustment of other controls may result in damage and often requires extensive work by an authorized technician to restore the product to normal operation.
 - E. If the product has been dropped and the base and/or handset has been damaged.

Important Safety Instructions

- F. If the product exhibits a distinct change in performance.
13. Avoid using a telephone (other than cordless) during an electrical storm. There is a remote risk of electric shock from lightning.
 14. Do not use the telephone to report a gas leak in the vicinity of the leak.
 15. Only put the handset of your telephone next to your ear when it is in normal talk mode.

VTECH COMMUNICATIONS INC.

Customer Service: www.vtechphones.com or 1-800-595-9511. In Canada; VTech Telecommunications Canada Ltd. at 1-800-267-7377.

BEFORE USING YOUR i 6763 SYSTEM, CAREFULLY PEEL OFF THE PROTECTIVE FILM COVERING THE DISPLAYS.

Your **i 6763** is an advanced cordless telephone set, capable of supporting two handsets. This manual is designed to familiarize you with this cordless telephone. We strongly recommend you read the manual before using your phone.

Parts Check List

1. Base Unit
2. Handsets (2)
3. Handset Charger
4. Base Power Adapter
5. Telephone Line Cord
6. Belt Clips (2)
7. Base Wall Mounting Bracket
8. Charger Wall Mounting Bracket
9. User's Manual
10. Batteries (2)

To purchase replacement batteries, visit us on the web at www.vtechphones.com or call VTech Communications, Inc. at 1-800-595-9511. In Canada, call VTech Telecommunications Canada Ltd. at 1-800-267-7377.

NOTE: Use only VTech batteries (part number 89-1323-00-00).



Handset x 2

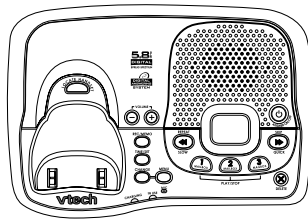

Base Unit

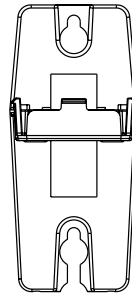

Base Wall Mounting Bracket

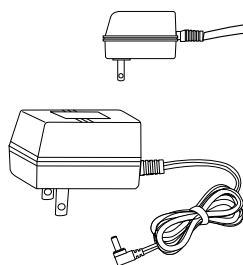

Base Power Adapter



Handset Charger

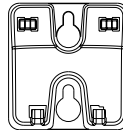

Charger Wall Mounting Bracket

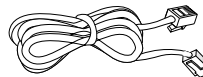

Telephone Line Cord



Belt Clip x 2

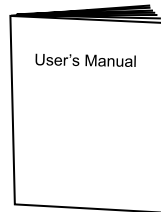

User's Manual
(English and Spanish)



Battery X 2

The Handset Layout

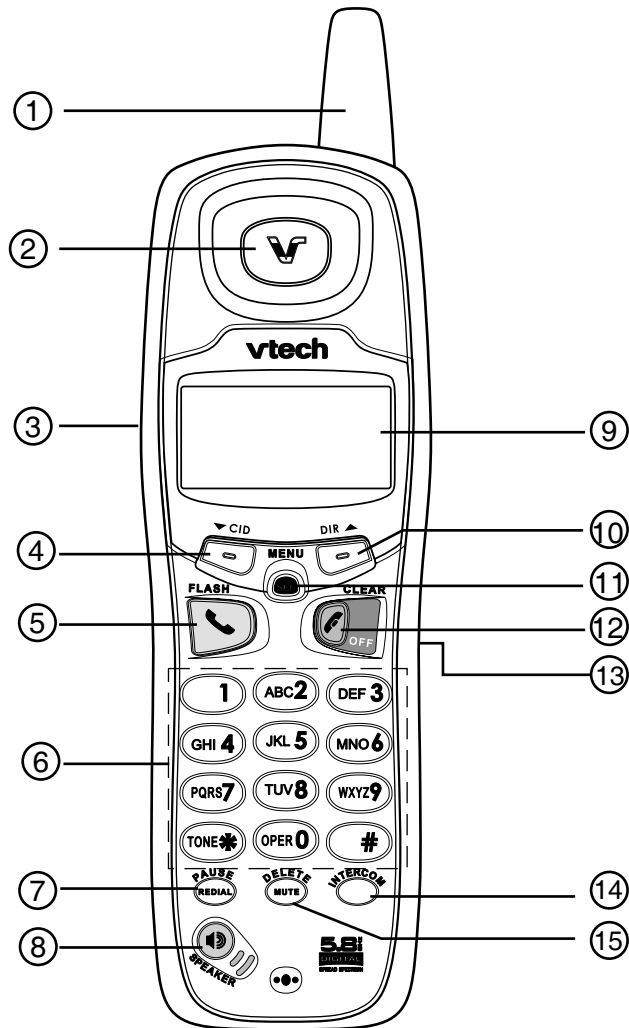

- | | |
|-----------------------------|--------------------------|
| 1. Antenna | 9. LCD Display |
| 2. Earpiece | 10. DIR (Scroll Up) |
| 3. Volume Control | 11. Select (Menu) |
| 4. CID (Scroll Down) | 12. Off (Clear) |
| 5. On (Flash) | 13. Headset Jack (2.5mm) |
| 6. Dialing Keys (0-9, *, #) | 14. Intercom |
| 7. Redial (Pause) | 15. Mute (Delete) |
| 8. Speaker | |

The Base Unit Layout

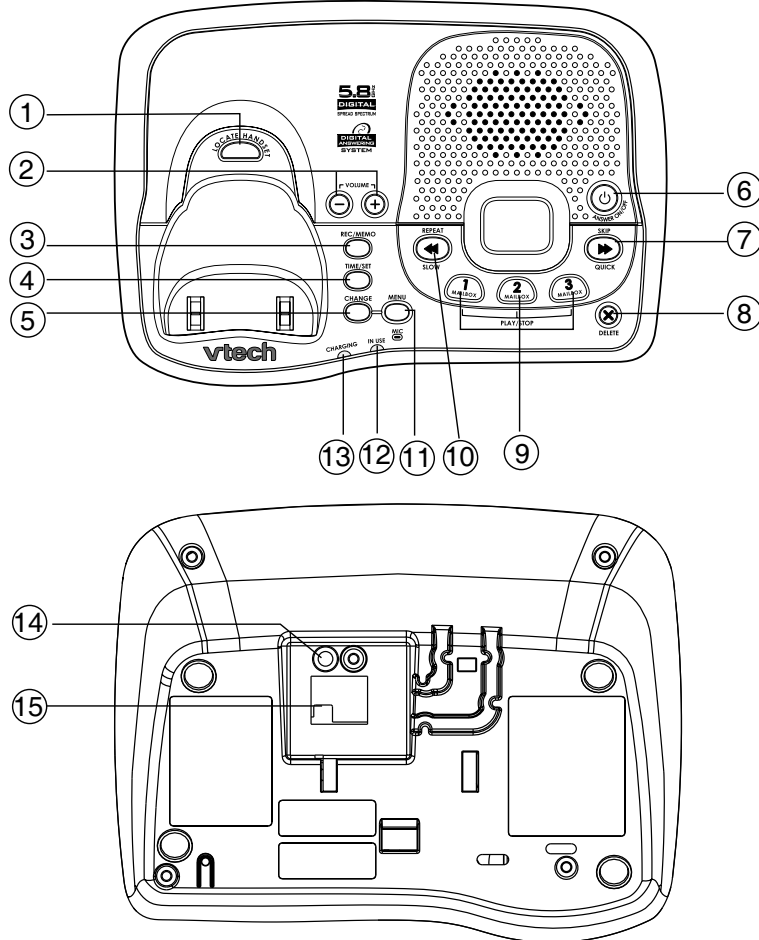

- | | |
|----------------------------|--------------------------|
| 1. Locate Handset | 10. Repeat/Slow |
| 2. Volume Control | 11. Menu |
| 3. Record/Memo | 12. In Use LED |
| 4. Time/Set | 13. Charging LED |
| 5. Change | 14. Power Connector Jack |
| 6. Answer On/Off | 15. Telephone Jack |
| 7. Skip/Quick | |
| 8. Delete | |
| 9. Message Boxes Play/Stop | |

Setup

Connecting Power to Base Unit/Handset Charger

1. Plug the power adapter into an electrical outlet not controlled by a wall switch, and the connector into the bottom of the base unit.

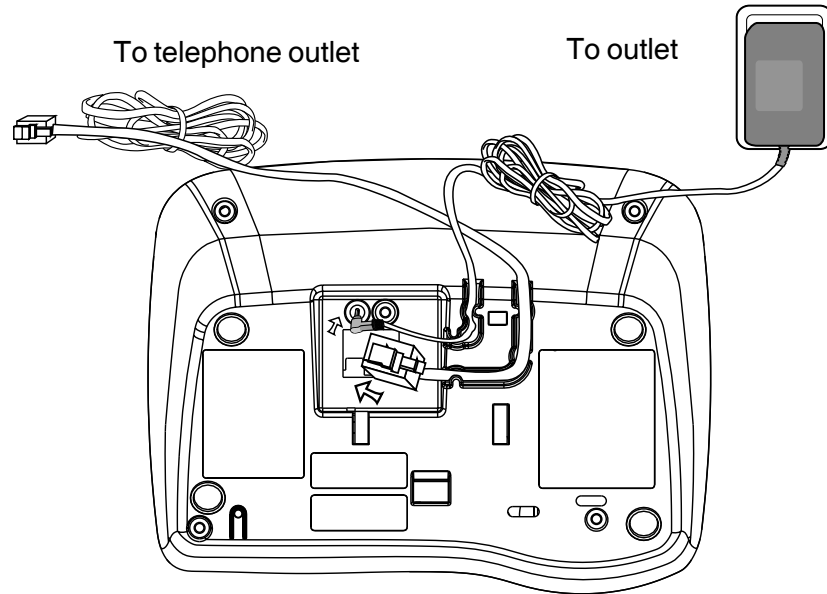

2. Choose the location for your handset charger, and plug its power supply into an electrical outlet.

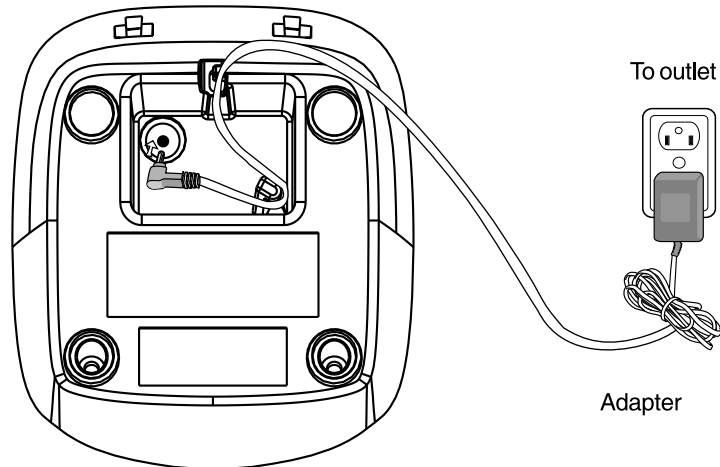

Setup

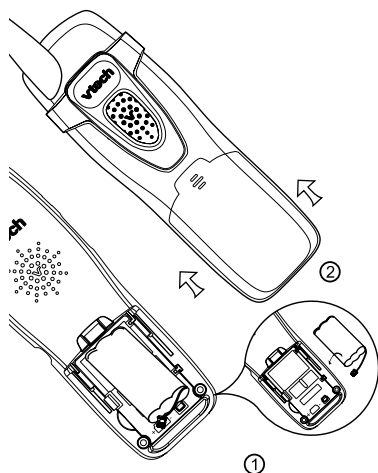

Installation of Handset Battery

1. Place the new battery in the handset with the positive and negative poles aligned in the battery compartment.
2. Replace the battery compartment cover by sliding it upward.
3. If the new battery is not already charged, place the handset in its charger or base unit, and allow it to charge for 10-12 hours. After the initial charge, a maintenance charge of eight hours should be sufficient. Be sure to place the handset in its base when not in use for maximum performance.

Charging of the Handset Battery

The handset of your cordless telephone is powered by rechargeable battery. It charges automatically whenever the handset is in its charger or base unit. Average talk time on a fully charged battery is about nine hours depending on environmental conditions, standby time is approximately four days.

You should charge the batteries for 10-12 hours when you first receive your phone. You will know the battery need charging when:

- The low battery message is displayed:
- The handset seems completely dead, the LCD is completely clear and does not activate when you press the keys.

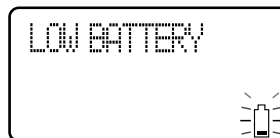

NOTE: When in **LOW BATTERY** mode, the keypad sounds, backlighting and speakerphone features will not work. When your battery has been charged, your features will return to their normal function.

IMPORTANT:

1. Do not dispose of battery in a fire, it might explode.
2. Do not open or mutilate the battery. Toxic substances may be released, causing harm to eyes or skin.
3. Exercise care in handling the battery in order to prevent an accidental short of the charge contacts, potentially causing the battery to overheat.
4. Do not dispose of the battery into household garbage. Properly recycle the battery.
5. For maximum performance, use only the power supply packaged with your VTech phone.

Setup

Check Battery Indicator

If you receive a check battery warning, it indicates one of the following:

1. There are no batteries in your handset. You'll need to install battery into your handset (see **Installation and Charge of Handset Battery** section on the previous page.)
2. The battery needs to be replaced with a new battery.
3. The battery has been installed incorrectly. Please reinstall (see **Installation of Handset Battery**) and/or the diagram in the battery compartment on the handset.

WARNING
CHECK BATTERY!

Connecting to Phone Line

Plug one end of the telephone line cord into the jack at the bottom of the base unit. Then plug the other end of the cord into the wall jack.

Checking for Dial Tone

After the battery are charged, press  /FLASH on the handset. You should hear a dial tone. If not, see **In Case of Difficulty**.

 **CAUTION:** Use only the VTech power supply provided with your telephone.

IMPORTANT! FOR MAXIMUM PERFORMANCE OF YOUR CORDLESS TELEPHONE SYSTEM:

1. Choose a central location for your base unit.
2. Install your base unit and extension handsets away from electronic equipment, such as personal computers, television sets and microwave ovens.
3. In locations where there are multiple cordless telephones, separate base units as far away as possible.
4. Install your telephone equipment away from heat sources and sunlight.
5. Avoid excessive moisture, dust or extreme cold.

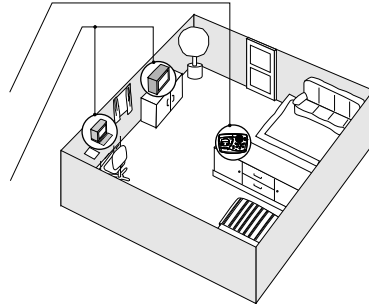

Wall Mounting

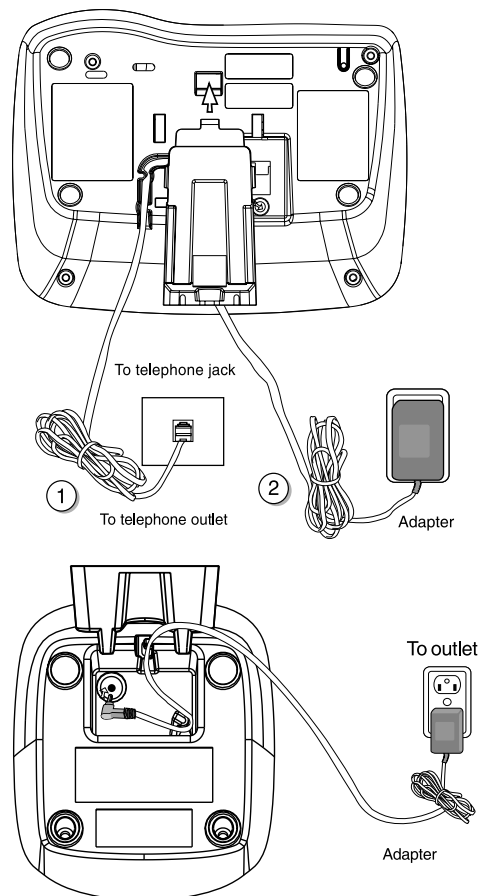

The wall mount brackets are designed for use on standard wall mount plates only. Wall mounting is optional.

1. Plug the adapters into electrical outlets. Then plug the connector of the base power adapter to the connector jack at the bottom of the base unit.
2. Connect the telephone line cord to the jack at the bottom of the base unit, and the other end to the wall jack.
3. Line up the tabs on the wall mount adapters with the holes at the bottom of the base unit/back of the handset charger. Snap the wall mount bracket firmly in place.
4. Mount the base unit/handset charger on the wall. Position the base unit/handset charger so that the mounting studs will fit into the holes on the wall mount bracket. Slide base unit/handset charger down on the mounting studs until it locks into place.



Handset and Base Indicators

Handset Icons

Icon	Description
MUTE	<ul style="list-style-type: none"> Turns on when the microphone is muted.
NEW	<ul style="list-style-type: none"> Turns on when there are new call log entries.
	<ul style="list-style-type: none"> Turns on when the ringer is muted.
	<ul style="list-style-type: none"> Low battery indicator or charging indicator.

Handset LEDs



LED	Description
	<ul style="list-style-type: none"> LED is on when in handsfree mode.

Base LEDs

LED	Description
IN USE	<ul style="list-style-type: none"> On when the phone is off the hook. Flashes when an extension phone is off the hook.
CHARGING	<ul style="list-style-type: none"> On when the handset is charging in the base.
PLAY/STOP 1, 2, 3	<ul style="list-style-type: none"> Flashes when new messages are in the corresponding mailbox. On when only old messages are in the corresponding mailbox.
Answer ON/OFF	<ul style="list-style-type: none"> On when the answering system is on.

Handset Operation

Making Calls

- Press  /FLASH (or **SPEAKER** to use the handset speakerphone feature). Dial the phone number.
- OR-
Dial the phone number first, then press  /FLASH (or **SPEAKER**).
- Press **OFF** to end your call or place the handset in its base.

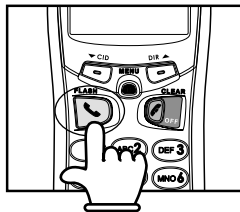

Answering Calls

- Press  /FLASH, **SPEAKER** or any dialing keys.
- Press **OFF** to end your call or place the handset in its base.

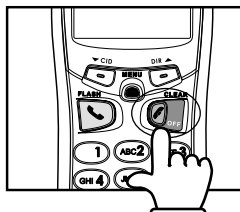

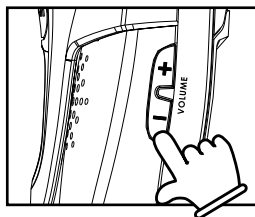

Adjust Handset Volume

The volume control is on the left edge of the handset. During a call, press the **VOLUME +** and **-** keys to adjust the listening volume to a comfortable level. When you reach the maximum or minimum setting, a double beep will sound.



NOTE: The procedure is the same for the handset earpiece, speakerphone and headset.

Flash Function

You can use your **i 6763** with services such as call waiting (fee required). When you receive a call waiting signal, press  /FLASH to switch to the new call. Press  /FLASH again to switch back to the original call.

NOTE: Use  /FLASH to access other phone company subscriber services, as described by your provider.

Redial Function

- Press **REDIAL/PAUSE** to display the last telephone number dialed from the handset (up to 32 digits). Use **▲** or **▼** to scroll through the last five numbers dialed.

When the beginning or the end of the redial list is reached, a double beep will sound.

- Press **OFF** to exit the redial review list.
- When the desired number is reached, press  /FLASH or **SPEAKER** to dial.
- When the desired entry displays, press **DELETE** to delete it. You'll hear a confirmation beep.

NOTE: If the redial memory is empty, and **REDIAL** is pressed, a double beep will sound.

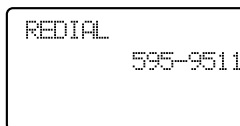

Handset Operation

Mute Function

- During a call, press the **MUTE/DELETE** key to disable the microphone. The screen will display **MICROPHONE MUTED** briefly:
- Press **MUTE/DELETE** again to return to normal two-way conversation. **MICROPHONE ON** will display briefly.

```
PHONE 00:00:15
MICROPHONE MUTED
MUTE
```

Intercom Call

- From idle (off) mode, press **INTERCOM**. The handset will display:
- The other handset will ring and the screen will display:
- Press **INTERCOM**, **SPEAKER** or any dialing key to answer the intercom call. The screens will display:
- Press **INTERCOM** or **OFF** on either handset to end the call, or simply place the handsets back in their charger.

```
CALLING
OTHER HANDSET
```

```
OTHER HANDSET
IS CALLING
```

```
INTERCOM
```

```
INTERCOM ENDED
```

```
UNABLE TO CALL
TRY AGAIN
```

NOTE: If the other handset is out of range, or on an external call, when you intercom it, the display of the first handset will show:

Call Forward and Call Transfer

An external call can be forwarded or transferred from one handset (HS1) to the other handset (HS2). The difference between forward and transfer depends on if HS1 wishes to speak with HS2 before the call is transferred.

Handset Operation

Call Forward

- A handset (HS1) on an external call can forward the call to the other handset (HS2) by pressing **and holding** the **INTERCOM** key. HS1 will initially show:
- HS2 can press **/FLASH** to answer the call. **NOTE:** If HS2 does not answer the call in about 30 seconds, the external call will be returned to HS1 and the display will show:
If the returned call is not answered within another 30 seconds, the external call will end automatically.

CALL FORWARDED

CALL BACK

Call Transfer

- HS1 can transfer an external call to HS2 by pressing the **INTERCOM** key. The external call is put on hold automatically.
 - HS2 will ring, showing an intercom call.
 - HS2 can answer the intercom call by pressing **/FLASH**.
 - Intercom is established while the external call is still on hold. HS1 may discuss the external call with HS2.
 - When HS1 presses **OFF**, the external call is then transferred to HS2. **CALL TRANSFERRED** will briefly display on HS1.
- NOTE:** If there is no answer on HS2, HS1 can reconnect to the held call by pressing **/FLASH**.

Conference Call

It is possible to establish a conference between two handsets and the external line.
If HS1 already has a connection to the external line, HS2 can join the call by pressing **/FLASH**, a conference will be immediately established. Both handsets will show:

CONF. 00:00:25

Base Operation

- From the base unit, press the **LOCATE HANDSET** key to locate the handsets.
- With the handset in idle, press **LOCATE HANDSET**. The handsets will display:
 - To end the page at the base, press **LOCATE HANDSET** again.
 - To end the page at the handset, press **/FLASH, SPEAKER** or any dial pad key (0-9, *, #) on handset, or press **LOCATE HANDSET** base.

BASE IS
PAGING

Phonebook Operation

Your **i 6763** can store up to 50 numbers with names in memory. Each memory location can hold up to 32 digits for the number and 16 characters for the name.

NOTE: The handsets share a common phonebook, which is stored in the base. This means that entries inserted by one handset are available for both handsets, and if one deletes a phonebook entry, it will disappear from both handsets.

When one handset is accessing the phonebook, the other handset cannot access it at the same time. If this is attempted, **NOT AVAILABLE AT THIS TIME** will display on the second handset.

Storing a New Entry

- Press **MENU**.
- With **PHONEBOOK** selected, press **SEL**.
- Press ▼ to select **STORE**. Press **SEL**.
- You will be prompted to **ENTER NUMBER**. Use the dialing keys to enter the number you wish to store in the phonebook. Press the **MUTE/DELETE** key to backspace and make corrections. Press **SEL**.
- You will then be prompted to **ENTER NAME**. Use the dialing keys to spell the name. Press **SEL**.
- You'll hear a confirmation tone, and the new phonebook entry will briefly be displayed.

```
>STORE
REVIEW
```

```
ENTER NUMBER
800-535-9511
```

```
ENTER NAME
---
```

NOTES:

- If the phonebook is full, the handset will display **PHONEBOOK IS FULL**.
- You can press **REDIAL/PAUSE**, then ▲ or ▼ to scroll to the previously dialed number from the redial list to store it into the phonebook. Press **SEL**.
- While entering numbers, press and hold **REDIAL/PAUSE** to add pauses if necessary.
- If the number is already in the phonebook, the display will show:

```
PHONE BOOK
IS FULL
```

```
NUMBER ALREADY
IN PHONE BOOK
```

Phonebook Operation

Each press of a particular key causes characters to be displayed in the following order:

Key	Characters by number of key presses								
	1	2	3	4	5	6	7	8	9
1	space	1							
2	A	B	C	2	a	b	c		
3	D	E	F	3	d	e	f		
4	G	H	I	4	g	h	i		
5	J	K	L	5	j	k	l		
6	M	N	O	6	m	n	o		
7	P	Q	R	S	7	p	q	r	s
8	T	U	V	8	t	u	v		
9	W	X	Y	Z	9	w	x	y	z
0	0								
*	*	?	!	/	()			
#	#	'	,	-	.	&			

Reviewing/Dialing from the Phonebook

- Press **MENU**. With **PHONEBOOK** in the first line, press **SEL**. With the **REVIEW** in the first line, press **SEL**.

- OR -

With the handset in idle, press **▲** to enter phonebook review mode. The first phonebook entry will be displayed.

- Scroll through phonebook entries using **▲** and **▼** or enter first character of the name to be searched (using the digit keys). Continue navigating using the **▲** or **▼** scroll keys, until you reach the entry to be dialed.

NOTE: When reviewing the phonebook, the second line of the display will show the number, up to 16 digits. For numbers longer than 16 digits, only the first 13 digits will be shown. Press ***** or **#** to scroll the phone number to see the additional digits.

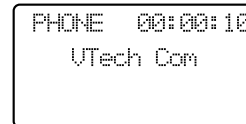
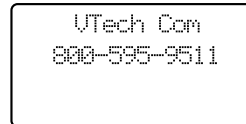

Phonebook Operation

- Press  /FLASH or **SPEAKER** to dial the number.

```
UTech Com
800-595-9511
```



NOTE: If there are no entries in the phonebook, when it is accessed, **PHONEBOOK IS EMPTY** will display.

Editing a Phonebook Entry

- Follow the steps in **Reviewing/Dialing from the Phonebook** (page 15) to reach the entry to be edited.
- Press **SEL** to enter number edit mode.

```
EDIT NUMBER
800-595-9511_
```

- Press **MUTE/DELETE** to backspace then press the digit keys to correct the number. Press and hold **REDIAL/PAUSE** to add pauses if necessary.

If you wish to store a number from redial memory into the phonebook, press **REDIAL/PAUSE** then  or  to scroll to desired redial number from memory. Press **SEL**.

- Press **SEL**.
- Press **MUTE/DELETE** to backspace and use the digit keys to enter the correct name.
- Press **SEL**. You'll hear a confirmation tone.

```
EDIT NAME
UTech Com_
```

Delete a Phonebook Entry

- Follow the steps in **Reviewing/Dialing from the Phonebook** (page 15) to reach the entry to be deleted.

```
UTech
595-9511
```

- Press **MUTE/DELETE** to delete the entry. You'll hear a confirmation tone.

```
UTech Com
800-595-9511
```

- The handset will then move to the next entry, if any.

```
UTech
595-9511
```

Call Log (Caller ID - Call Waiting)

Caller ID - Call Waiting ID

Your i 6763 is capable of displaying the number of the calling party before you answer the phone (**caller ID** or **CID**). If the number is contained in the phonebook, the name of the caller will also be displayed. It is also capable of displaying CID information in conjunction with a call waiting alert signal (**call waiting caller ID**). With call waiting caller ID, the CID data is displayed so you can decide whether to answer the incoming call, or continue with your current conversation. Your i 6763 can hold up to 50 CID entries.

NOTES ABOUT CALLER ID & CALL WAITING CALLER ID These are subscription services, provided by most regional telephone service providers. You must subscribe to these services to get the benefits of these features. If you do not subscribe to CID services, you can still use your i 6763 and the other features it offers.

Due to regional incompatibilities, CID information may not be available for every call you receive. In addition, the calling party may intentionally block their name and/or phone number from being sent.

- As new CID/call waiting ID records are received, your handset displays will alert you to the new CID records, for example:
- After you review all new CID records, the **NEW** call indicator will be turned off and the screen will show:
- If the call log is full, the oldest entry is deleted to make room for the new call. If the call log is empty when you try to enter to call log review, the following message is displayed:

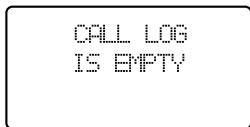

Reviewing Caller ID

You can review the CID records via the menu as described below, or by pressing ▼ while in idle, and the handset jumps directly to CID review.

- In idle mode, press **MENU**.
- Press ▼ to scroll to the **CALL LOG** option.

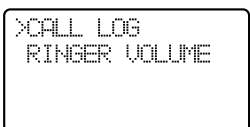

Call Log (Caller ID - Call Waiting)

- Press **SEL**. Use ▲ and ▼ to scroll through the call log entries. When the beginning or the end of the call log is reached, a double beep will sound.

```
UTech Com
800-595-9511
NEW 2/23 11:59AM
```

NOTE: The NEW icon in the lower left corner indicates the call has not yet been reviewed.

Storing Caller ID

- Follow the steps in **Reviewing Caller ID** to scroll to the record to be stored.
- To view alternate dialing sequences, press the # key repeatedly. The screen will cycle through the various dialing options (1 + area code + number, area code + number, 1 + number, number only.) Press SEL to store the displayed number.
- If the CID record contains both name and number, the CID will be stored after pressing **SEL**.
- If the CID record does not contain a name, you will be prompted to **EDIT NAME** and the screen will show:
- If the CID record does not contain a number, you will be prompted to **EDIT NUMBER**, and the screen will show:
- You'll hear a confirmation beep and the screen will display:
- If both name and number are missing, for example as in a private listing, the request will be rejected with the message:
- If the number already exists in the phonebook, the entry will not be stored, and the screen will show:
- If the phonebook is full, the screen will show:

```
EDIT NAME
UTech Com_
```

```
EDIT NUMBER
800-595-9511_
```

```
ADDED TO
PHONE BOOK
```

```
UNABLE TO SAVE
IN PHONE BOOK
```

```
NUMBER ALREADY
IN PHONE BOOK
```

```
PHONE BOOK
IS FULL
```

Dialing from Caller ID

- Follow the steps in **Reviewing Caller ID** to

Call Log (Caller ID - Call Waiting)

- scroll to the entry to be dialed.
- To change how the number will be dialed, (1 + area code + number, area code + number, 1 + number, number only.) press # repeatedly. The screen will cycle through the dialing options. Press /FLASH or **SPEAKER** key to dial the number.

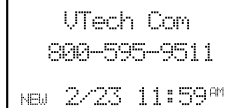

VTech Com
800-535-9511
NEW 2/23 11:59 AM

Deleting Caller ID

- Follow the steps in **Reviewing Caller ID** to scroll to the record to be deleted.
- Press the **DELETE** key to delete the desired record. You'll hear a confirmation beep and the previous CID record will be displayed on the screen.
- To delete all the CID records, press and hold the **DELETE** key. The screen will ask you **DELETE ALL CALLS?** Press **SEL** to confirm. Press **OFF** to return to the CID record previously displayed.

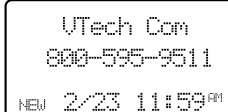

VTech Com
800-535-9511
NEW 2/23 11:59 AM



DELETE ALL
CALLS?

Handset Settings

Ringer Volume

- From the idle (off) mode, press **SEL** then ▲ or ▼ to **RINGER VOLUME**.
- Press **SEL**. The current ringer volume will be shown:
- Press ▲ and ▼ or enter a digit (0 through 6) to the desired ringer volume. The current ring tone will play and the volume bar is increased or decreased each time the setting is adjusted. At the lowest setting the display will show:
- Press **SEL**.

```
>RINGER VOLUME
RINGER TONE
```

```
RINGER VOLUME
■■■■■
```

```
RINGER VOLUME
```



NOTE: The handset will not ring when a call comes in if ringer volume is set to the lowest setting.

Ringer Tone

- From idle (off) mode, press **SEL** then ▲ or ▼ to **RINGER TONE**.
- Press **SEL**. You are prompted to select **INTERCOM CALL** or **OUTSIDE CALL**. Press ▲ or ▼ to select the desired option.
- Press **SEL**. You can then use ▲ or ▼ or enter a digit (0 through 9) to sample the ring tone.
- Press **SEL** to confirm.

```
>RINGER TONE
KEY TONE
```

```
>INTERCOM CALL
OUTSIDE CALL
```

Key Tone (preset to ON)

- From the idle (off) mode, press **SEL** then ▲ or ▼ to **KEY TONE**.
- Press **SEL**. The current setting will be shown. Press ▲ or ▼ to scroll to **ON** or **OFF**. When set to **ON**, the handset will emit a beep whenever a key is pressed.
- When the desired option is shown, press **SEL**.

```
>KEY TONE
HANDSET NAME
```

```
KEY TONE
OFF
```

Handset Settings

Handset Name (preset to VTECH)

- You can give each handset its own unique name (such as kitchen or office). The name is shown in the first line when the handset is idle. The name can be a up to 16 characters in length.
- From idle (off) mode, press **SEL** then **▲** or **▼** to **HANDSET NAME**.
- Press **SEL**. The display will show the current setting, for example:
- Press **DELETE** to backspace then enter the desired name.

```
HANDSET NAME
VTECH_
```

```
HANDSET NAME
Kitchen_
```

NOTE: The characters are entered in the same way as for the phonebook, see the table on page 15.

- Press **SEL** to confirm.

Language (preset to English)

- From the idle (off) mode, press **MENU** then **▲** or **▼** to **LANGUAGE**.
- Press **SEL**. Press **▲** or **▼** to scroll from English to French or Spanish.
- Press **SEL** to confirm.

```
>LANGUAGE
DIAL TYPE
```

```
LANGUAGE
FRENCH
```

Dial Type (preset to Tone)

- From idle (off) mode, press **MENU** then **▲** or **▼** to **DIAL TYPE**.
- Press **SEL** then **▲** or **▼** to scroll to **TONE** or **PULSE**.
- Press **SEL** to confirm.

```
>DIAL TYPE
PHONE BOOK
```

```
DIAL TYPE
PULSE
```

NOTE: When the phone is set for pulse dial mode, it is possible to switch to temporary tone mode during an ongoing call by pressing ***TONE**. Once pressed, tone will be used for rest of the call. After you hang up, the phone will return to pulse dialing for the next call.

Answering System Operation

Audible Indicators

This system gives you voice prompts for feature operations and voice confirmations when you press a button or complete an operation.

Turn Answering System On or Off

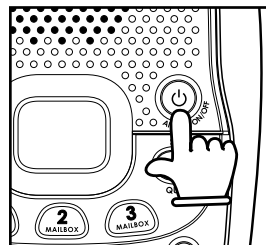

Press **ANSWER ON/OFF** to turn the system on or off. When the system is turned on, you will hear "Answering machine on" and the **ANSWER ON/OFF** light will be lit. When the system is off, you will hear "Answering machine off" and the **ANSWER ON/OFF** light will not be lit. The system will answer after 10 rings if it is off, then announce "Please enter your remote access code" and wait for you to enter your two digit code to access code. (See **Remote Access** on page 30 for details.)

Set the Clock

When **CL** flashes in the message window, you will need to set the correct day and time at the base.



1. Press **TIME/SET**. The time and day will be announced, followed by "To begin setting the clock, press **TIME/SET**, then press **CHANGE** to change the setting or press **TIME/SET** to continue." Press **TIME/SET** again. The day will be announced.
2. Press **CHANGE** until the system announces the correct day, then press **TIME/SET**. The system announces the current hour setting.
3. Press **CHANGE** until the system announces the correct hour, press **TIME/SET**. The system announces the current minute setting.
4. Press **CHANGE** to advance the minutes one at a time.

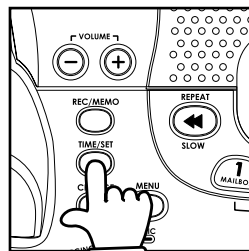

- OR -

Press and hold **CHANGE** to advance the minutes in increments of 10.

- Press **TIME/SET**, the system announces the current year.
 - Press **CHANGE** to advance the year one at a time.
- OR-**
- Press and hold **CHANGE** to advance the years in increase of 10.
- When the system announces the correct year, press **TIME/SET**.
 5. Press **CHANGE** until the system announces the correct year, then press **TIME/SET**. The system announces the current clock setting.

Answering System Operation

NOTES:

1. You can set the time manually, or allow it to be set automatically with incoming caller ID information. (If you subscribe to CID service, fee required.)
2. Press any **PLAY/STOP** button to exit programming at any time. The **PLAY/STOP** buttons are located on the base unit and are labeled numbers **1, 2, and 3**. These buttons also playback messages left in their respective mailbox.

About Mailboxes

This answering system has three voice mailboxes. Callers using a touch tone phone can select the mailbox in which their messages will be recorded by pressing 1, 2, or 3 while the system plays the outgoing announcement. Otherwise, messages will be recorded in mailbox **1**.

About Announcements

- You can record two different announcements - one for normal answering and one for when the system is set to play the announcement only.
- Use normal answering when you want the system to record callers' messages. Use announcement only when you want to give information to callers without accepting messages.
- If you choose not to record an announcement, the system answers with a pre-recorded announcement.
- The normal answering pre-recorded announcement says: *"Hello, please leave a message after the tone."* The announcement only pre-recorded announcement says: *"We're sorry messages to this number cannot be accepted."*
- By setting announcement only to on or off, you decide which announcement your callers will hear when the system answers a call (the system comes set for normal answering, with announcement only turned off). See **Set Announcement Only** on page 25 to change your announcement selection.

Record Your Announcement

NOTE: If you have assigned different mailboxes to different people, be sure to tell callers in your announcement to press 1, 2 or 3 to leave a message in the appropriate mailbox. Remember to leave a few seconds at the end of your recorded announcement to allow callers enough time to select a mailbox.

An example of an announcement:

"Thank you for calling. To leave a message for Bob, press 1 now; to leave a message for Sue, press 2 now; to leave a message for Elmo, press 3 now; or, wait for the beep and leave your message."

The system will record your announcement for the currently selected answer mode (normal or announcement only). To confirm or change the answer mode, follow the directions under **Answering System Feature Setup** and **Feature Summary** on pages 24 and 25.

Answering System Operation

1. With the system set for the desired answer mode (normal or announcement only) press **MENU** until you hear "Announcement. Press **MAILBOX** or press **RECORD**. To continue setup, press **MENU**."
2. Press **REC/MEMO**. After you hear "Record after the tone. Press **MAILBOX** when you are done." followed by a beep, speak toward the base to record an announcement up to 90 seconds long.
3. Press any **PLAY/STOP** button to stop recording. The system plays back your recorded message.

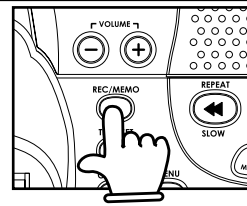

Review Your Announcement:

1. Press **MENU** until you hear "Announcement. Press **MAILBOX** or press **RECORD**. To continue setup, press **MENU**."
2. Press any **PLAY/STOP** button. The system plays the current announcement.

Delete Your Announcement:

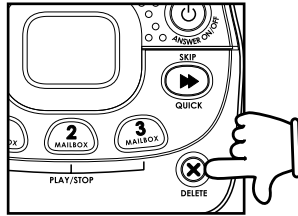

Press **DELETE** during announcement playback. The system will use the pre-recorded announcement until you record a new one.

Answering System Feature Setup

You can set up one feature at a time, or you can set up one feature then move on to set up features in sequence.

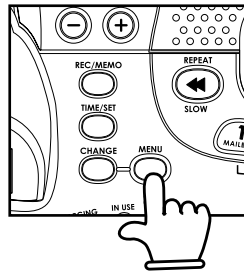
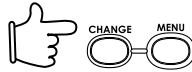

1. Make sure the answering system is on.
2. Press and release **MENU** until you hear the system announce the feature you want to set. Refer to **Feature Summary** on page 25 for a description of the features and options.
3. Press **CHANGE** until the system announces the desired setting.
4. Press **TIME/SET**.
5. Press **MENU** to move on to the next feature, or press a mailbox button to confirm your selection and exit feature setup.

Answering System Operation

FEATURE SUMMARY	(Default setting indicated by “*”)
SYSTEM ANNOUNCES:	DESCRIPTION/DIRECTIONS:
<p><i>Remote access code. To change the setting press CHANGE.</i> 50*</p>	<p>Set the remote access code you will use to access features and functions of the answering system from a touch tone phone. Choose a two digit number from 40 to 99.</p>
<p><i>"Message alert. To change the setting press CHANGE."</i> Off* On</p>	<p>When message alert is turned on the base beeps once every 10 seconds when new messages have been received.</p>
<p><i>"Announcement only, record no messages. To change the setting press CHANGE."</i> Off* On</p>	<p>When you turn announcement only on, callers hear your announcement but cannot leave a message.</p>
<p><i>"Base ringer. To change the setting press CHANGE."</i> On* Off</p>	<p>Turn the base ringer on or off.</p>
<p><i>"Number of rings. To change the setting press CHANGE."</i> 2 4* 6 Toll Saver</p>	<p>Choose how many times the phone will ring before the system answers. With toll saver active, the system answers after two rings when you have new messages and after four rings when you have no new messages.</p>

NOTE: Exit feature setup at any time by pressing any **PLAY/STOP** button.

Answering System Operation

This system automatically saves your messages until you delete them, and can store approximately 15 minutes of messages, memos and announcements (up to a maximum of 99 messages). A message or memo can be up to four minutes long. If the system has less than 30 seconds of recording time left, it automatically turns off. The system will still answer after 10 rings, announce *"Memory is full. Enter remote access code."* and wait for the code to be entered. (See **Remote Access** on page 30 for details.)

When you have new messages or memos, the **PLAY/STOP** light for each mailbox with new messages will flash.

Listen to Messages

A mailbox key will flash if you have new messages. If all messages in that mailbox are old, the key will glow steadily.

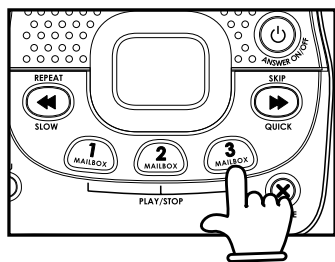

Press the **PLAY/STOP** button for the mailbox you want to review. The system announces the mailbox number, the number of new messages and the number of old messages. The system then plays only new messages in the mailbox. After all new messages are played, press the **PLAY/STOP** button again to hear all (old) messages.

Before each message or memo plays, the system announces the day and time it was received. While a message plays, the message window displays the number of that message.

Press **REPEAT/SLOW** during playback to hear a message again. Press **REPEAT/SLOW** twice to backup and replay the previous message.

Press **SKIP/QUICK** during playback to skip to the next message.

Press and hold **SKIP/QUICK** or **REPEAT/SLOW** during message playback to speed up or slow down playback of a message.

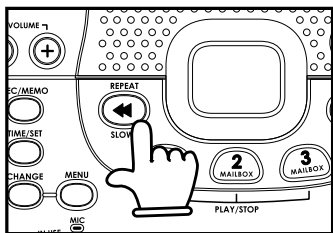

After playing the last message in a mailbox, the system announces *"End of messages."* If the system has less than five minutes of recording time left, it announces the remaining time.

Answering System Operation

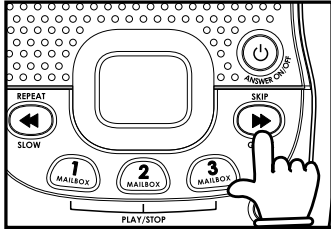

Press the **PLAY/STOP** button at any time during playback to exit message playback. You'll hear a confirmation beep.

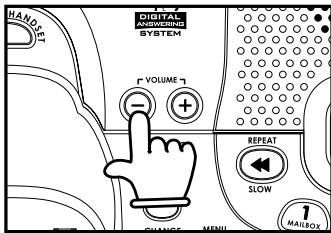

Adjust Playback Volume

Press **VOL +** or **VOL -** to adjust playback volume to a comfortable level. If volume is set to level one, you will not hear incoming messages as they are received.

The system beeps three times when you reach the highest or lowest volume setting.

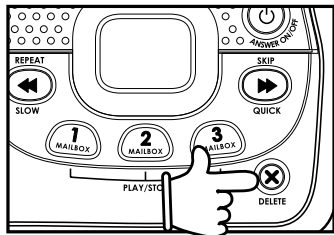

Delete Messages

NOTE: Deleted messages cannot be recovered.

Delete a Specific Message:

Press **DELETE** while a message is playing to delete only that message.

Delete All Messages in a Mailbox:

Press **DELETE**. The system announces, *"Please select mailbox."* Press the desired **PLAY/STOP** button. The system erases all old (previously reviewed) messages and memos in that mailbox.

Answering System Operation

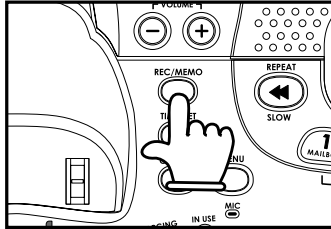

Record a Memo

You can record a memo up to four minutes long to store as an incoming message.

1. Press and release **REC/MEMO**. The system announces *"Please select mailbox."*
2. Press the **PLAY/STOP** button to select a mailbox for the memo. After the system announces *"Record after the tone. Press MAILBOX when you are done."* speak towards the base microphone. The message window displays the length of your memo, up to 99 seconds. If you record longer memo, 99 continues to flash until you finish.
3. To stop recording, press **PLAY/STOP**.

Call Screening

1. Set the base playback volume to a level greater than **1** to hear messages as they are left.
2. Press **FLASH** on the handset, to pick up the call. The answering system will stop recording.
3. If you don't want to screen messages, set the volume level to **1**.

Answering System Operation

MESSAGE WINDOW DISPLAY

WINDOW DISPLAYS	TO INDICATE:
0	No messages in any mailbox.
1-98	Total number of messages in all mailboxes.
0-99 ↔ F	Memory is full or total number of messages is 99.
Counting 1 to 99	Duration of announcement or memo recording. (Maximum length of announcement is 90 seconds.)
99 (Flashing)	Length of recording is more than 99 seconds.
1-99 (Flashing)	New message number during message playback.
1-8 (Steady for one second)	Indicates volume level selected when VOL- or VOL+ is pressed.
40-99	Current remote access code while setting.
A	Announcement only mode.
On or Off (Steady for one second)	Displayed when any setting is changed to on or off.
CL ↔ (Normal display)	Clock needs to be set.
-- (Steady)	System is answering a call or is in remote operation.
-- (Flashing)	System is in programming mode or initializing.

Answering System Operation

Remote Access

You can access many features of this system remotely from a touch tone phone.

1. Dial your telephone number.
2. When the system answers, enter your remote access code (preset to 50). The system beeps once and announces the number of new messages on the system.
3. Enter a remote command (see **Remote Access Commands** below).
4. Press * 0 to exit remote operation.

Voice Menu

The system has voice prompts to help you with remote operation.

Press * 5 to hear the menu while remotely connected to the answering system.

REMOTE ACCESS COMMANDS

FUNCTION:	COMMAND:
Play messages in a mailbox	Press #, then the desired mailbox number (1, 2 or 3). The system plays new messages. If there are no new messages the system plays old messages.
Repeat a message	Press #4 while message is playing; press #4 twice to back up previous message.
Skip a message	Press #6 while message is playing; each press advances next message.
Stop	Press #5.
Save messages	Hang up.
Delete message	Press #9 while message is playing.
Review announcement	Press #7; system plays announcement, then beeps.
Record announcement	Press *7; after beep, record announcement, press #5 to stop. System plays back announcement.
Record memo (If accessing from a touch tone telephone, press #5 to stop recording.)	Press *8, then the mailbox number where you want memo recorded; speak after the system announces "Record after the tone." Press MAILBOX when you are done." Press #5 to stop.
End remote access call	Press *0.
Turn system off	Press #0; the system announces, "Answering machine off." Press #0 again to turn the system back on.
Turn system on	When system is off, it answers after 10 rings and announces, "Please enter your remote access code." Enter your remote access code.

NOTE: If no key is pressed within 10 seconds of entering remote access, the voice menu will be announced. After the voice menu announcement, if no key is pressed within 20 seconds, the remote access call will automatically end.

Headset Operation

Your **i 6763** handset is equipped with a 2.5mm headset jack for use with an optional accessory headset for handsfree operation. If you choose to use the headset option, you must obtain an optional accessory headset that is compatible with the **i 6763**.

To purchase a headset, visit us on the web at www.vtechphones.com or call VTech Customer Service at 1-800-595-9511.

Once you have a compatible 2.5mm headset, locate the headset jack on the **i 6763** handset. Connect the plug on the headset cord to the jack (under a small rubber flap) on the handset. The plug should fit securely. Do not force the connection.

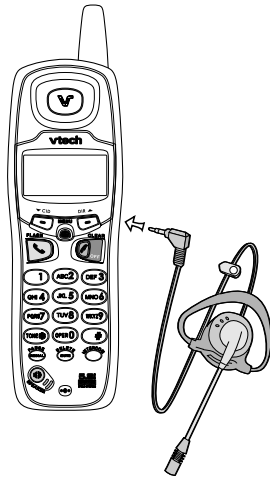

NOTE:

Whenever a compatible headset is connected to the cordless handset, the microphone on the handset will be muted. This is done to limit the effect of background noise.

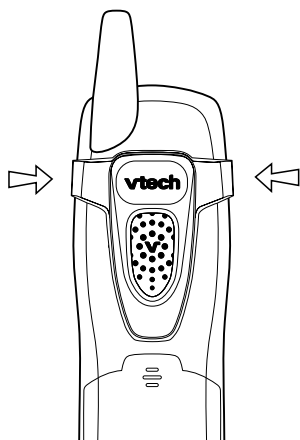

Belt Clip

Your **i 6763** is also equipped with a detachable belt clip. Align the pins on the inside edge of the clip with the notches on the sides of the handset. The belt clip should snap securely into place. Do not force the connection.

In Case Of Difficulty

If you have difficulty operating your phone, the suggestions below should solve the problem. If you still have difficulty after trying these suggestions, call VTech Communications at 1-800-595-9511. In Canada, call VTech Telecommunications Canada Ltd. at 1-800-267-7377.

The phone doesn't work at all

- Make sure the power cord is plugged in.
- Make sure the telephone line cord is plugged firmly into the base unit and the telephone wall jack.
- Make sure the batteries are properly charged. If you get a **LOW BATTERY** message or indication, the batteries need charging.

No dial tone

- First try all the suggestions above.
- If you still don't hear a dial tone, disconnect the base unit from the telephone jack and connect a different phone. If there is no dial tone on that phone either, the problem is in your wiring or local service. Contact your local telephone company.

You get noise, static, or a weak signal even when you're near the base unit

- Household appliances plugged into the same circuit as the base unit can sometimes cause interference. Try moving the appliance or the base unit to another outlet.

You get noise, static, or a weak signal when you're away from the base unit

- You may be out of range. Either move closer to the base, or relocate the base unit.
- The layout of your home may be limiting the range. Try moving the base unit to another position.

The handset does not ring when you receive a call

- Make sure you have the ringer activated. Refer to the section(s) on **ringer selection** in this user's manual.
- Make sure the telephone line cord is plugged firmly into the base unit and the telephone jack. Make sure the power cord is plugged in.
- You may be too far from the base unit.
- You may have too many extension phones on your telephone line to allow all of them to ring. Try unplugging some of the other phones.

In Case Of Difficulty

You hear other calls while using your phone

- Disconnect your base unit from the telephone jack, and plug in a regular telephone. If you still hear other calls, the problem is probably in your wiring or local service. Call your local telephone company.

You hear noise in the handset, and none of the keys or buttons work

- Make sure the power cord is plugged in.

Common cure for electronic equipment

If the unit does not seem to be responding normally, then try putting the Handset in its base. If it does not seem to respond, do the following (in the order listed):

1. Disconnect the power to the base.
2. Disconnect the handset battery, and spare battery, if applicable.
3. Wait a few minutes.
4. Connect power to the base.
5. Re-install the battery.
6. Wait for the handset to re-establish its link with the base. To be safe, allow up to one minute for this to take place.

Your answering system is not recording messages

- Make sure system is turned ON (the ANSWER ON/OFF light is illuminated).
- Make sure the Announce Only feature is set to OFF.

You cannot hear recorded messages

- Using the base volume control, raise the volume to a comfortable listening level.

CL is flashing in the Base Message Window Display:

- You need to set the day and time. Refer to the section(s) on Set the Clock in this user's manual.

Maintenance

Taking care of your telephone

Your cordless telephone contains sophisticated electronic parts, so it must be treated with care.

Avoid rough treatment

Place the handset down gently. Save the original packing materials to protect your telephone if you ever need to ship it.

Avoid water

Your telephone can be damaged if it gets wet. Do not use the handset outdoors in the rain, or handle it with wet hands. Do not install your base unit near a sink, bathtub or shower.

Electrical storms

Electrical storms can sometimes cause power surges harmful to electronic equipment. For your own safety, use caution when using electric appliances during storms.

Cleaning your telephone

Your telephone has a durable plastic casing that should retain its luster for many years. Clean it only with a soft cloth slightly dampened with water or a mild soap. Do not use excess water or cleaning solvents of any kind.

Remember that electrical appliances can cause serious injury if used when you are wet or standing in water. If your base unit should fall into water, DO NOT RETRIEVE IT UNTIL YOU UNPLUG THE POWER CORD AND TELEPHONE LINE CORDS FROM THE WALL. Then pull the unit out by the unplugged cords.

Warranty Statement

What does this limited warranty cover?

- The manufacturer of this VTech product, VTech Communications, warrants to the holder of a valid proof of purchase (“Consumer” or “you”) that the product and all accessories provided by VTech in the sales package (“Product”) are free from material defects in material and workmanship, pursuant to the following terms and conditions, when installed and used normally and in accordance with operation instructions, This limited warranty extends only to the Consumer for Products purchased and used in the United States of America.

What will VTech Communications do if the Product is not free from material defects in materials and workmanship during the limited warranty period (“Materially Defective Product”)?

- During the limited warranty period, VTech’s authorized service representative will repair or replace at VTech’s option, without charge, a Materially Defective Product. If we repair this product, we may use new or refurbished replacement parts. If we choose to replace this product, we may replace it with a new or refurbished product of the same or similar design. VTech will return repaired or replacement products to you in working condition. VTech will retain defective parts, modules, or equipment. Repair or replacement of Product, at VTech’s option, is your exclusive remedy. You should expect the repair or replacement to take approximately 30 days.

How long is the limited warranty period?

- The limited warranty period for the product extends for ONE(1) YEAR from the date of purchase if we repair or replace a Materially Defective Product under the terms of this limited warranty. This limited warranty also applies to repaired or replacement Products for a period of either (a) 90 days from the date the repaired or replacement Product is shipped to you or (b) the time remaining on the original one-year warranty; whichever is longer.

What is not covered by this limited warranty?

This limited warranty does not cover

1. Product that has been subjected to misuse, accident, shipping or other physical damage, improper installation, abnormal operation or handling, negligent, inundation, fire, water or other liquid intrusion; or
2. Product that has been damaged due to repair, alteration or modification by anyone other than an authorized service representative of VTech; or
3. Product to the extent that the problem experienced is caused by signal conditions, network reliability or cable or antenna systems; or
4. Product to the extent that the problem is caused by use with non-VTech electrical accessories; or
5. Product whose warranty/quality stickers, Product serial numbers plates or electronic serial numbers have been removed, altered or rendered illegible; or

Warranty Statement

6. Product purchased, used, serviced, or shipped for repair from outside the United States, or used for commercial or institutional purposes (including but not limited to Products used for rental purposes); or
7. Product returned without valid proof of purchase (see 2 below); or
8. Charges for installation or set up, adjustment of customer controls, and installation or repair of systems outside the unit.

How do you get warranty service?

- To obtain warranty service in the United States of America, call 1-800-595-9511 for instructions regarding where to return the Product. Before calling for service, please check the user's manual. A check of the Product controls and features may save you a service call.
- Except as provided by applicable law, you assume the risk of loss or damage during transit and transportation and are responsible for delivery or handling charges incurred in the transport of Product(s) to the service location. VTech will return repaired or replaced product under this limited warranty to you, transportation, delivery or handling charges prepaid. VTech assumes no risk for damage or loss of the Product in transit.
- If the Product failure is not covered by this limited warranty, or proof of purchase does not meet the terms of this limited warranty, VTech will notify you and will request that you authorize the cost of repair and return shipping costs for the repair of Products that are not covered by this limited warranty.

What must you return with the Product to get warranty service?

1. Return the entire original package and contents including the Product to the VTech service location along with a description of the malfunction or difficulty;
2. Include "valid proof of purchase" (sales receipt) identifying the Product purchased (Product model) and the date of purchase or receipt; and
3. Provide your name, complete and correct mailing address, and telephone number.

Other Limitations

- This warranty is the complete and exclusive agreement between you and VTech. It supersedes all other written or oral communications related to this Product. VTech provides no other warranties for this product. The warranty exclusively describes all of VTech's responsibilities regarding the product.

There are no other express warranties. No one is authorized to make modifications to this limited warranty and you should not rely on any such modification.

State Law Rights: This warranty gives you specific legal rights, and you may also have other rights, which vary from state to state.

Warranty Statement

Limitations: Implied warranties, including those of fitness for a particular purpose and merchantability (an unwritten warranty that the product is fit for ordinary use) are limited to one year from date of purchase. Some states do not allow limitations on how long an implied warranty lasts, so the above limitation may not apply to you.

- In no event shall VTech be liable for any indirect, special, incidental, consequential, or similar damages (including, but not limited to lost profits or revenue, inability to use the product, or other associated equipment, the cost of substitute equipment, and claims by third parties) resulting from the use of this product, some states do not allow the exclusion or limitation of incidental or consequential damages, so the above limitation or exclusion may not apply to you.

FCC, ACTA and IC Regulations

This equipment complies with Parts 15 of the Federal Communications Commission (FCC) rules for the United States. It also complies with regulations RSS210 and CS-03 of Industry and Science Canada. Operation is subject to the following two conditions: (1) this device may not cause interference, and (2) this device must accept any interference, including interference that may cause undesired operation of the device.

A label is located on the underside of the base unit containing either the FCC registration number and Ringer Equivalence Number (REN) or the IC registration number and Load Number. You must, upon request, provide this information to your local telephone company.

This equipment is compatible with inductively coupled hearing aids.

Should you experience trouble with this telephone equipment, please contact:

VTech Communications Inc.

CUSTOMER SERVICE at 1-800-595-9511. In Canada, call VTech Telecommunications Canada Ltd. at 1-800-267-7377.

For repair/warranty information. The telephone company may ask you to disconnect this equipment from the line network until the problem has been corrected.

FCC Part 15

Warning: Changes or modifications to this unit not expressly approved by the party responsible for compliance could void the user's authority to operate the equipment.

The equipment has been tested and found to comply with part 15 of the FCC rules. These limits are designed to provide reasonable protection against harmful interference in a residential installation. This equipment generates, uses and can radiate radio frequency energy and, if not installed and used in accordance with the instructions, may cause harmful interference to radio communications.

However, there is no guarantee that interference will not occur in a particular installation. If this equipment does cause harmful interference to radio or television reception, which can be determined by turning the equipment off and on, the user is encouraged to try and correct the interference by one or more of the following measures:

- Reorient or relocate the receiving antenna.
- Increase the separation between the equipment and receiver.
- Connect the equipment into an outlet or on a circuit different from that to which the receiver is connected.
- Consult the dealer or an experienced radio/TV technician for help.

To ensure safety of users, the FCC has established criteria for the amount of radio

FCC, ACTA and IC Regulations

frequency energy that can be safely absorbed by a user or bystander according to the intended usage of the product. This product has been tested and found to comply with the FCC criteria. The handset has such a low power that it does not require testing. It may be safely held against the ear of the user. The base unit shall be installed & used such that parts of the user's body other than the hands should be maintained at a comfortable distance of approximately 20 cm or more.

FCC Part 68 and ACTA

If this equipment was approved for connection to the telephone network prior to July 23, 2001, it complies with Part 68 of the Federal Communications Commission (FCC) rules. If the equipment was approved after that date, it complies with the Part 68 rules and with Technical Requirements for Connection of Equipment to the Telephone Network adopted by the Administrative Council for Terminal Attachments (ACTA). We are required to provide you with the following information.

1. Product identifier and REN information

The label on the back or bottom of this equipment contains, among other things, an identifier indicating product approval and the Ringer Equivalence Number (REN). This information must be provided to your local telephone company upon request. For equipment approved prior to July 23, 2001, the product identifier is preceded by the phrase "FCC Reg No." and the REN is listed separately. For equipment approved after that date, the product identifier is preceded by "US" and a colon (:), and the REN is encoded in the product identifier without a decimal point as the sixth and seventh characters following the colon. For example, the product identifier US:AAAEQ03T123XYZ would indicate an REN of 0.3. The REN is used to determine how many devices you may connect to your telephone line and still have them ring when you are called. In most, but not all areas, the sum of all RENs should be five (5.0) or less. You may want to contact your local telephone company for more information.

2. Connection and use with the nationwide telephone network

The plug and jack used to connect this equipment to the premises wiring and the telephone network must comply with the applicable Part 68 rules and technical requirements adopted by ACTA. A compliant telephone cord and modular plug is provided with this product. It is designed to be connected to a compatible modular jack that is also compliant. An RJ11 jack should normally be used for connecting to a single line and an RJ14 jack for two lines. See Installation Instructions in the user's manual. This equipment may not be used with Coin Telephone Lines or with Party Lines. If you have specially wired alarm dialing equipment connected to your telephone line, ensure the connection of this equipment does not disable your alarm equipment. If you have questions about what will disable alarm equipment, consult your telephone company or a qualified installer.

FCC, ACTA and IC Regulations

3. Repair instructions

If this equipment is malfunctioning, it must be unplugged from the modular jack until the problem has been corrected. Repairs to this telephone equipment can only be made by the manufacturer or its authorized agents. For repair procedures, follow the instructions outlined under the Limited Warranty.

4. Rights of the telephone company

If this equipment is causing harm to the telephone network, the telephone company may temporarily discontinue your telephone service. The telephone company is required to notify you before interrupting service. If advance notice is not practical, you will be notified as soon as possible. You will be given the opportunity to correct the problem and the telephone company is required to inform you of your right to file a complaint with the FCC. Your telephone company may make changes in its facilities, equipment, operation, or procedures that could affect the proper functioning of this product. The telephone company is required to notify you if such changes are planned.

5. Hearing aid compatibility

If this product is equipped with a corded or cordless handset, it is hearing aid compatible.

6. Programming/testing of emergency numbers

If this product has memory dialing locations, you may choose to store police, fire department and emergency medical service telephone numbers in these locations. If you do, please keep three things in mind:

- a We recommend that you also write the telephone number on the directory card, so that you can still dial the emergency number manually if the memory dialing feature doesn't work.
- b This feature is provided only as a convenience, and the manufacturer assumes no responsibility for customer reliance upon the memory feature.
- c Testing the emergency telephone numbers you have stored is not recommended. However, if you do make a call to an emergency number:
 - You must remain on the line and briefly explain the reason for the call before hanging up.
 - Programming/testing of emergency numbers should be performed during off-peak hours, such as in the early morning or late evening, when the emergency services tend to be less busy.

IC (Industry Canada)

This telephone is registered for use in Canada. The term "IC:" before the radio certification number only signifies that Industry Canada technical specifications were met.

FCC, ACTA and IC Regulations

Notice:

This equipment meets the applicable Industry Canada Terminal Equipment Technical Specifications. This is confirmed by the registration number. The abbreviation, IC, before the registration number signifies that registration was performed based on a Declaration of Conformity indicating that Industry Canada technical specifications were met. It does not imply that Industry Canada approved the equipment.

Notice:

The Ringer Equivalence Number (REN) for this terminal equipment is 0.1. The REN assigned to each terminal equipment provides an indication of the maximum number of terminals allowed to be connected to a telephone interface. The termination on an interface may consist of any combination of devices subject only to the requirement that the sum of the Ringer Equivalence Numbers of all the devices does not exceed five.

Before installing this equipment, user should ensure that it is permissible to be connected to the facilities of the local telecommunications company. The equipment must also be installed using an acceptable method of connection. The customer should be aware that compliance with the above conditions may not prevent degradation of services in some situations.

Repairs to certified equipment should be made by an authorized Canadian maintenance facility designated by the supplier. Any repairs or alterations made by the user to this equipment, or equipment malfunctions, may give the telecommunications company cause to request the user to disconnect the equipment.

Users should ensure for their own protection that the electrical ground connections of the power utility, telephone lines and internal metallic water pipe system, if present, are connected together. This precaution may be particularly important in rural areas.

Caution:

Users should not attempt to make such connections themselves, but should contact the appropriate electrical inspection authority, or electrician, as appropriate.

Your Cordless Phone is designed to operate at the maximum power allowed by the FCC and IC. This means your handset and base unit can communicate only over a certain distance - which will depend on the location of the base unit and handset, weather, and the construction and layout of your home or office.

Technical Specifications

FREQUENCY CONTROL

Crystal controlled
PLL synthesizer

TRANSMIT FREQUENCY

Base: 5725 - 5850 MHz
Handset: 2400 - 2483.5 MHz

RECEIVE FREQUENCY

Base: 2400 - 2483.5 MHz
Handset: 5725 - 5850 MHz

CHANNELS

95 Channels

NOMINAL EFFECTIVE RANGE

Maximum power allowed by FCC and IC. Actual operating range may vary according to environmental conditions at the time of use.

SIZE

Handset: 182mm x 58mm x 46mm
(including antenna)
Base: 168mm x 128mm x 75mm
Charger: 96mm x 78mm x 74mm

WEIGHT

Handset: 184 grams
(excluding batteries)
Base: 342 grams
Charger: 100 grams

POWER REQUIREMENTS

Handset: 3.6V 600mAh NiMH
Base: 8V DC @ 650mA
Charger: 9 VDC @ 150mA

MEMORY

Phonebook: 50 Memory locations;
up to 16 digits per location
CID: 50 Memory locations

**SPECIFICATIONS ARE TYPICAL
AND MAY CHANGE WITHOUT
NOTICE.**

Index

Answering Calls.....	11	Key Tone.....	20
Adjust Handset Volume.....	11	Language.....	21
Adjust Playback Volume.....	27	Listen to Messages.....	26
Answering System Operation.....	22	Maintenance.....	34
Audible Indicators.....	22	Making Calls.....	11
About Mailboxes.....	23	Message Window Display.....	29
About Announcements.....	23	Mute Function.....	12
Answering System Feature Setup.....	24	Parts Check List.....	3
Base LEDs.....	10	Phonebook Operation.....	14
Base Operation.....	13	Redial Function.....	11
Belt Clip.....	31	Reviewing/Dialing from the Phonebook.....	15
Calls Log (Caller ID-Call Waiting)...	17	Reviewing Caller ID.....	17
Caller ID - Call Waiting ID.....	17	Record Your Announcement.....	23
Call Forward and Call Transfer.....	12	Review Your Announcement.....	24
Call Screening.....	28	Record a Memo.....	28
Charging of the Handset Battery	7	Remote Access Commands.....	30
Check Battery Indicator.....	8	Remote Access.....	30
Checking for Dial Tone.....	8	Remote Access Commands.....	30
Connecting Power to Base Unit/ Handset Charger.....	6	Ringer Volume.....	20
Connecting to Phone Line.....	8	Ringer Tone.....	20
Conference Call.....	13	Setup.....	6
Delete a Phonebook Entry.....	16	Set the Clock.....	22
Deleting Caller ID.....	19	Storing a New Entry.....	14
Delete Your Announcement.....	24	Storing a Caller ID.....	18
Delete Messages.....	27	Technical Specifications.....	42
Dialing from Caller ID.....	18	The Handset Layout.....	4
Dial Type.....	21	The Base Unit Layout.....	5
Editing a Phonebook Entry.....	16	Turn Answering System On or Off...22	
FCC, ACTA and IC Regulations.....	38	Voice Menu.....	30
Feature Summary.....	25	Wall Mounting.....	9
Flash Function.....	11	Warranty Statement.....	35
Handset and Base Indicators.....	10		
Handset Icons.....	10		
Handset LEDs.....	10		
Handset Operation.....	11		
Handset Settings.....	20		
Handset Name.....	21		
Headset Operation.....	31		
Important Safety Instructions.....	1		
Installation of Handset Battery.....	7		
Intercom Call.....	12		
In Case Of Difficulty.....	32		



vtech

VTECH TELECOMMUNICATIONS LTD.

vtech A member of THE VTECH GROUP OF COMPANIES.

Distributed in the U.S.A. by VTech Communications, Inc. Beaverton, Oregon, 97008.

Distributed in Canada by VTech Telecommunications Canada Ltd., Richmond, B.C.
V6X 1Z9.

Copyright 2005 for VTECH TELECOMMUNICATIONS LTD.

Printed in China

91-000212-050-000
issued 0





Table Of Contents

IMPORTANT SAFETY INSTRUCTIONS.....	1
Parts Check List.....	3
The Handset Layout.....	4
The Base Unit Layout.....	5
GETTING STARTED.....	6
Setup.....	6
Connecting Power to Base Unit/Handset Charger.....	6
Installation of Handset Battery.....	7
Charging of the Handset Battery.....	7
Check Battery Indicator.....	8
Connecting to Phone Line.....	8
Checking for Dial Tone.....	8
Wall Mounting.....	9
BASIC OPERATION.....	10
Handset and Base Indicators.....	10
Handset Icons.....	10
Handset LEDs.....	10
Base LEDs.....	10
Handset Operation.....	11
Making Calls.....	11
Answering Calls.....	11
Adjust Handset Volume.....	11
Flash Function.....	11
Redial Function.....	11
Mute Function.....	12
Intercom Call.....	12
Call Forward and Call Transfer.....	12
Conference Call.....	13
Base Operation.....	13
Phonebook Operation.....	14
Storing a New Entry.....	14
Reviewing/Dialing from the Phonebook.....	15
Editing a Phonebook Entry.....	16
Delete a Phonebook Entry.....	16
Calls Log (Caller ID-Call Waiting).....	17
Caller ID - Call Waiting ID.....	17
Reviewing Caller ID.....	17
Storing a Caller ID.....	18
Dialing from Caller ID.....	18
Deleting Caller ID.....	19
Handset Settings.....	20
Ringer Volume.....	20
Ringer Tone.....	20

Table Of Contents

Key Tone	20
Handset Name	21
Language	21
Dial Type	21
ANSWERING SYSTEM OPERATION.....	22
Audible Indicators.....	22
Turn Answering System On or Off.....	22
Set the Clock.....	22
About Mailboxes.....	23
About Announcements.....	23
Record Your Announcement.....	23
Review Your Announcement.....	24
Delete Your Announcement.....	24
Answering System Feature Setup.....	24
Feature Summary.....	25
Listen to Messages.....	26
Adjust Playback Volume.....	27
Delete Messages.....	27
Record a Memo.....	28
Call Screening.....	28
Message Window Display.....	29
Remote Access.....	30
Voice Menu.....	30
Remote Access Commands.....	30
ADVANCED OPERATION.....	31
Headset Operation.....	31
Belt Clip	31
ADDITIONAL INFORMATION.....	32
In Case Of Difficulty.....	32
Maintenance.....	34
Warranty Statement.....	35
FCC, ACTA and IC Regulations.....	38
Technical Specifications	42



Congratulations on your purchase
of this VTech product

NEED HELP?

Our representatives are here
to help you with any questions
concerning the operation of this
product, available accessories,
or any other related issues.

Call Toll Free:

1-800-595-9511

In Canada, Call:

1-800-267-7377

or visit our website at
www.vtechphones.com

