

vtech®

Innovation Beyond Technology™

User's Manual



Model: IP 811

5.8
GHz
Digital Spread
Spectrum

Accessory Handset

Important Safety Instructions

When using your telephone equipment, basic safety precautions should always be followed to reduce the risk of fire, electric shock and injury, including the following:

1. Read and understand all instructions.
2. Follow all warnings and instructions marked on the product.
3. Unplug this product from the wall outlet before cleaning. Do not use liquid or aerosol cleaners. Use a damp cloth for cleaning.
4. Do not use this product near water (for example, near a bath tub, kitchen sink or swimming pool).
5. Do not place this product on an unstable surface, such as a table, shelf or stand. The product may fall, causing serious damage.
6. Slots and openings in the back or bottom of the base unit and handset are provided for ventilation. To protect them from overheating, these openings must not be blocked by placing the product on a soft surface such as a bed, sofa or rug. This product should never be placed near or over a radiator or heat register. This product should not be placed in any area where proper ventilation is not provided.
7. This product should be operated only from the type of power source indicated on the marking label. If you are not sure of the type of power supply in your home, consult your dealer or local power company.
8. Do not allow anything to rest on the power cord. Do not install this product where the cord may have anyone walking on it.
9. Never push objects of any kind into this product through slots in the base or handset as they may touch dangerous voltage points or short out parts that could result in a risk of fire or electric shock. Never spill liquid of any kind on the product.
10. To reduce the risk of electric shock, do not disassemble this product, but take it to an authorized service facility. Opening or removing parts of the base or handset other than specified access doors may expose you to dangerous voltages or other risks. Incorrect reassembling can cause electric shock when the product is subsequently used.
11. Do not overload wall outlets and extension cords as this can result in the risk of fire or electric shock.
12. Unplug this product from the wall outlet and refer servicing to an authorized service facility under the following conditions:
 - A. When the power supply cord or plug is damaged or frayed.
 - B. If liquid has been spilled onto the product.
 - C. If the product has been exposed to rain or water.
 - D. If the product does not operate normally by following the operating instructions. Adjust only those controls that are covered by the operating instructions, as improper adjustment of other controls may result in damage and often requires extensive work by an authorized technician to restore the product to normal operation.
 - E. If the product has been dropped and the base and/or handset has been damaged.
 - F. If the product exhibits a distinct change in performance.
13. Avoid using a telephone (other than cordless) during an electrical storm. There is a remote risk of electric shock from lightning.
14. Do not use the telephone to report a gas leak in the vicinity of the leak.
15. Only put the handset of your telephone next to your ear when it is in normal talk mode.

Important Safety Instructions

VTech Communications, Inc. Customer Service: www.vtechphones.com or 1-800-595-9511. In Canada, call VTech Telecommunications Canada Ltd. at 1-800-267-7377.

BEFORE USING YOUR IP 811, CAREFULLY PEEL OFF THE PROTECTIVE FILM COVERING THE DISPLAYS.

IMPORTANT:

Your IP 811 is an accessory handset for use with the IP 8100-2/8100-3 systems. You must have one of these base units in order to use the accessory handset. This manual is designed to familiarize you with the IP 811 accessory handset setup, registration and basic functions. For detailed instructions, please refer to the IP 8100-2/8100-3 user's manual.

Parts Check List

- | | |
|----------------------------------|------------------|
| 1. Handset | 4. Belt Clip |
| 2. Handset Charger | 5. User's Manual |
| 3. Charger Wall Mounting Bracket | 6. Battery Pack |

To purchase replacement batteries, visit us on the web at www.vtechphones.com or call VTech Communications, Inc. at 1-800-595-9511. In Canada, call VTech Telecommunications Canada Ltd. at 1-800-267-7377.

NOTE: Use only VTech batteries (part number 89-1324-00-00).



Handset

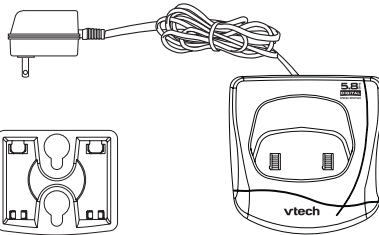

Charger Wall Mounting Bracket

Handset Charger



Belt Clip



Battery Pack

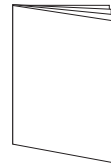

User's Manual

The Handset Layout

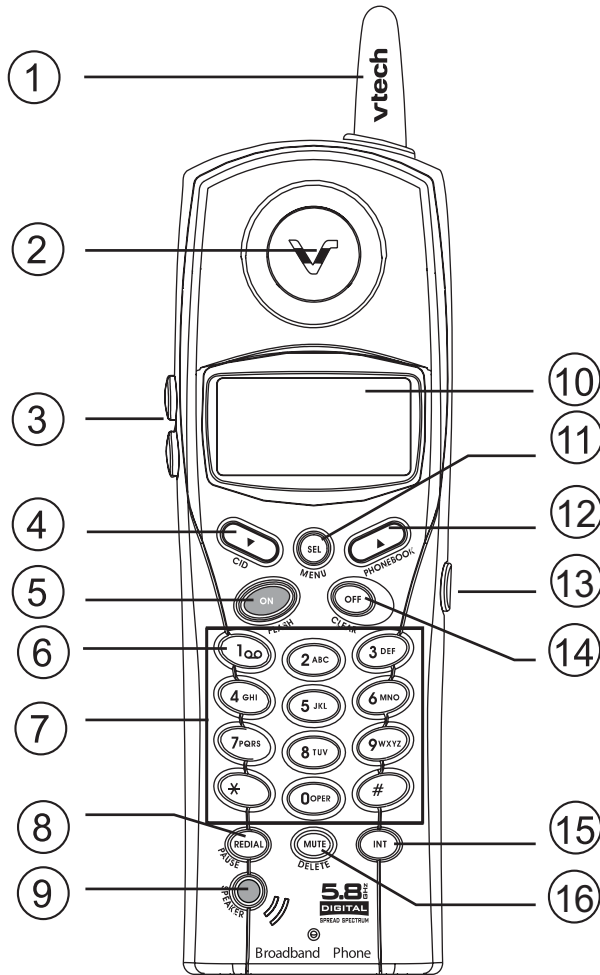

- | | |
|-----------------------------|---------------------------|
| 1. Antenna | 9. Speakerphone |
| 2. Earpiece | 10. LCD Display |
| 3. Volume Control | 11. Select (Menu) |
| 4. CID (Scroll Down) | 12. Phonebook (Scroll Up) |
| 5. On (Flash) | 13. Headset jack (2.5mm) |
| 6. Voicemail | 14. Off (Clear) |
| 7. Dialing Keys (0-9, *, #) | 15. Intercom |
| 8. Redial (Pause) | 16. Mute (Delete) |

Setup

Connecting Power to Handset Charger

Because the IP 811 is an accessory handset to the IP 8100-2/8100-3 all you need to do is choose the location for your handset charger and plug in the power supply into an electrical outlet.

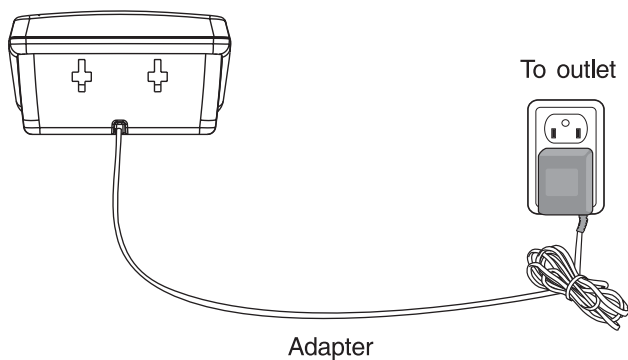

CAUTION: Use only the VTech power supply provided with your telephone.

Installation of Battery Pack

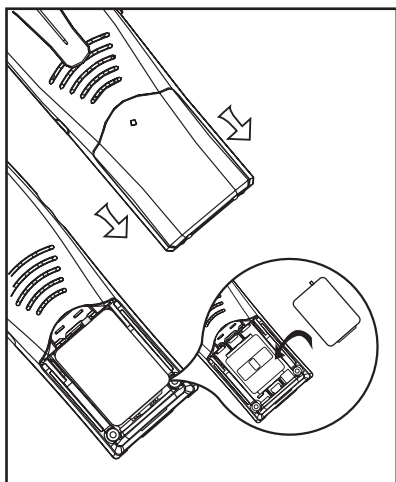

1. Remove battery compartment cover by pressing on the indentation and sliding downward.
2. Place the new battery pack in the handset with the positive and negative poles aligned in the battery compartment.
3. Replace the battery pack cover by sliding it upwards.
4. If the new battery is not already charged, place the handset in its charger and allow it to charge for 10-12 hours.
5. After the initial charge, a maintenance charge of 10-12 hours should be sufficient. Be sure to place the handset in its charger when not in use to insure maximum daily performance.
6. Average talk time on a fully charged battery is about nine hours, standby time is approximately four days.

Setup

Charging of the Handset Battery

The handset of your cordless telephone is powered by a rechargeable battery. It charges automatically whenever the handset is in its charger.

You should charge the battery for 10-12 hours when you first receive your phone. You will know the battery needs charging when:

- The low battery message is displayed:
- The handset seems completely dead, the LCD is completely clear and does not activate when you press the keys.

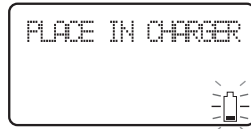

IMPORTANT:

1. Do not dispose of battery pack in a fire, it might explode.
2. Do not open or mutilate the battery pack. Toxic substances may be released, causing harm to eyes or skin.
3. Exercise care in handling battery pack in order to prevent an accidental short of the charge contacts, potentially causing the batteries to overheat.
4. Do not dispose of this battery pack into household garbage, it should be properly recycled.
5. Do not charge the batteries with other electrical devices.
6. If the phone will not be used for a long period of time, remove the battery to prevent possible leakage.

Checking for Dial Tone

After the handset is registered and the battery is charged, press **ON** on the handset. The LCD displays **PHONE** and shows a call timer, and you will hear a dial tone. If not, see **In Case of Difficulty**.

Wall Mounting

The wall mount brackets are designed for use on standard wall mount plates only. wall mounting is optional. Only the handset chargers (not the main base unit) can be wall mounted.

1. Plug the power adapters into electrical outlets, and the connector to the bottom of the handset charger.
2. Line up the tabs on the wall mount brackets with the holes at the back of the handset charger. Snap the wall mount bracket firmly in place.
3. Mount the handset charger on the wall. Position the handset charger so the mounting studs will fit into the holes on the wall mount bracket. Slide handset charger down on the mounting studs until it locks into place.

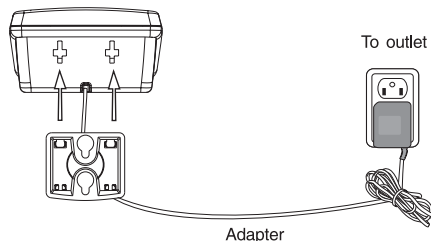

Registration

Your IP 811 is an accessory handsets for use with the IP 8100-2/8100-3 base unit. To register your IP 811 for the first time:

1. After charging the battery, the screen will display:

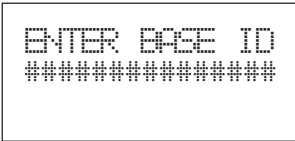

```
ENTER BASE ID
#####
```

2. Enter the 15 digit base unit ID code, located on the underside of your IP 8100-2/8100-3 base. If you make a mistake, press the **DELETE** key to backspace (delete characters), then enter the correct information.



```
SEARCHING...
```

3. Press **SEL** to complete the registration process.
4. Once a valid base ID code has been entered, the display will blank for a second or two, and then show:

5. If the base accepts the new handset, after several seconds the new handset will show:





```
HANDSET X
```

Where X is the new handset number assigned, sequentially, by the base.

NOTE: If any of the digits are entered incorrectly press the DELETE key to erase a character(s) and carefully re-enter the correct base ID code. If you have entered any digits incorrectly you will hear an error tone after the SEL key is pressed. The 15-digit base ID code may contain numbers and characters, including 0 through 9 and *. Make sure you enter all 15 digits.

Handset Indicators

Handset Icons

Icon	Description
MUTE	<ul style="list-style-type: none">• Turns on when the microphone is muted.
NEW	<ul style="list-style-type: none">• Turns on when there are new call log entries.
	<ul style="list-style-type: none">• Turns on when the ringer is muted.
	<ul style="list-style-type: none">• Low battery indicator and charging indicator.

Handset LEDs

LED	Description
SPEAKER	<ul style="list-style-type: none">• LED is on when in handsfree mode.

Headset Operation

Headset Operation

Your IP 811 handset is equipped with a 2.5mm headset jack for use with an optional accessory headset for handsfree conversations. If you choose to use the headset option, you must obtain an optional accessory headset that is compatible with the IP 811.

To purchase a headset, visit us on the web at www.vtechphones.com or call VTech Customer Service at 1-800-595-9511.

Once you have a compatible 2.5mm headset, locate the headset jack on the IP 811 handset. Connect the plug on the headset cord to the jack (under a small rubber flap) on the cordless handset. The plug should fit securely. Do not force the connection.

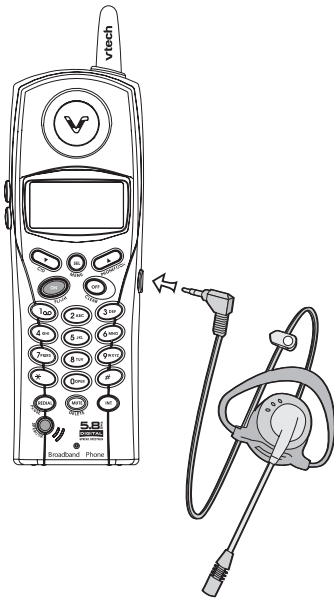

NOTE:

- Whenever a compatible headset is connected to the cordless handset, the microphone on the handset will be muted. This is done to limit the effect of background noise.
- When a compatible headset is connected to the cordless handset, your speakerphone feature will be disabled. To use your speakerphone feature, simply disconnect the headset from the handset.

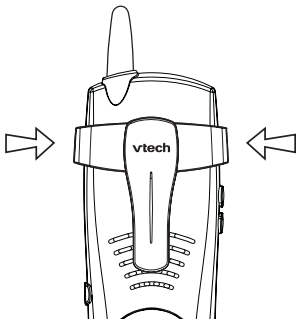

Belt Clip

The IP 811 is also equipped with a detachable belt clip. Align the pins on the inside edge of the clip with the notches on the sides of the handset. The belt clip should snap securely into place. Do not force the connection.

Maintenance

Taking Care Of Your Telephone

Your cordless telephone contains sophisticated electronic parts, so it must be treated with care.

Avoid rough treatment

Place the handset down gently. Save the original packing materials to protect your telephone if you ever need to ship it.

Avoid water

Your telephone can be damaged if it gets wet. Do not use the handset outdoors in the rain, or handle it with wet hands. Do not install your base unit near a sink, bathtub or shower.

Electrical storms

Electrical storms can sometimes cause power surges harmful to electronic equipment. For your own safety, use caution when using electric appliances during storms.

Cleaning your telephone

Your telephone has a durable plastic casing that should retain its luster for many years. Clean it only with a soft cloth slightly dampened with water or a mild soap. Do not use excess water or cleaning solvents of any kind.

Remember that electrical appliances can cause serious injury if used when you are wet or standing in water. If your base unit should fall into water, **DO NOT RETRIEVE IT UNTIL YOU UNPLUG THE POWER CORD AND ETHERNET CABLE FROM THE WALL.** Then pull the unit out by the unplugged cords.

In Case Of Difficulty

The Phone Doesn't Work At All

- Make sure the power cord is plugged in.
- Make sure the Ethernet cable is plugged firmly into the base unit and the broadband connection.
- Make sure the batteries are properly charged. If you get a **LOW BATTERY** message or indication, the batteries need charging.

No Dial Tone

- First check all the suggestions above.
- Please refer to the **Troubleshooting** section of the **Base Unit Features Manual of IP 8100-2/8100-3**.

You Get Noise, Static, Or A Weak Signal Even When You're Near The Base Unit

- Household appliances plugged into the same circuit as the base unit can sometimes cause interference. Try to move the appliance or the base unit to another outlet.

You Get Noise, Static, Or A Weak Signal When You're Away From The Base Unit

- You may be out of range. Either move closer to the base, or relocate the base unit.
- The layout of your home may be limiting the range. Try to move the base unit to another position.

The Handset Does Not Ring When You Receive A Call

- Make sure you have the ringers activated. Refer to the section(s) on **Ringer Volume** in IP 8100-2/ 8100-3 user's manual.
- Make sure the ethernet cable is plugged firmly into the base unit and the broadband connection. Make sure the power cord is plugged in.
- You may be too far from the base unit.

You Hear Noise In The Handset, And None Of The Keys Or Buttons Work

- Make sure the power cord is plugged in.

Common Cure For Electronic Equipment

If the unit does not seem to be responding normally, then try to put the handset in the charger. If it does not seem to respond, do the following (in the order listed):

1. Disconnect the power to the base.
2. Disconnect the handset battery pack.
3. Wait a few minutes.
4. Connect power to the base.
5. Re-install the battery pack.
6. Watch for handset to display **HANDSET X** or your own handset name.



Warranty Statement

What does this limited warranty cover?

- The manufacturer of this VTech product, VTech Communications, warrants to the holder of a valid proof of purchase (“Consumer” or “you”) that the product and all accessories provided by VTech in the sales package (“Product”) are free from material defects in material and workmanship, pursuant to the following terms and conditions, when installed and used normally and in accordance with operation instructions. This limited warranty extends only to the Consumer for Products purchased and used in the United States of America.

What will VTech Communications do if the Product is not free from material defects in materials and workmanship during the limited warranty period (“Materially Defective Product”)?

- During the limited warranty period, VTech’s authorized service representative will repair or replace at VTech’s option, without charge, a Materially Defective Product. If we repair this product, we may use new or refurbished replacement parts. If we choose to replace this product, we may replace it with a new or refurbished product of the same or similar design. VTech will return repaired or replacement products to you in working condition. VTech will retain defective parts, modules, or equipment. Repair or replacement of Product, at VTech’s option, is your exclusive remedy. You should expect the repair or replacement to take approximately 30 days.

How long is the limited warranty period?

- The limited warranty period for the product extends for ONE(1) YEAR from the date of purchase if we repair or replace a Materially Defective Product under the terms of this limited warranty. This limited warranty also applies to repaired or replacement Products for a period of either (a) 90 days from the date the repaired or replacement Product is shipped to you or (b) the time remaining on the original one-year warranty; whichever is longer.

What is not covered by this limited warranty?

This limited warranty does not cover

1. Product that has been subjected to misuse, accident, shipping or other physical damage, improper installation, abnormal operation or handling, negligent, inundation, fire, water or other liquid intrusion; or
2. Product that has been damaged due to repair, alteration or modification by anyone other than an authorized service representative of VTech; or
3. Product to the extent that the problem experienced is caused by signal conditions, network reliability or cable or antenna systems; or
4. Product to the extent that the problem is caused by use with non-VTech electrical accessories; or
5. Product whose warranty/quality stickers, Product serial numbers plates or electronic serial numbers have been removed, altered or rendered illegible; or
6. Product purchased, used, serviced, or shipped for repair from outside the United States, or used for commercial or institutional purposes (including but not limited to Products used for rental purposes); or
7. Product returned without valid proof of purchase (see 2 below); or
8. Charges for installation or set up, adjustment of customer controls, and installation or repair of systems outside the unit.

Warranty Statement

How do you get warranty service?

- To obtain warranty service in the United States of America, call 1- 800-595- 9511 for instructions regarding where to return the Product. Before calling for service, please check the user's manual. A check of the Product controls and features may save you a service call.
- Except as provided by applicable law, you assume the risk of loss or damage during transit and transportation and are responsible for delivery or handling charges incurred in the transport of Product(s) to the service location. VTech will return repaired or replaced product under this limited warranty to you, transportation, delivery or handling charges prepaid. VTech assumes no risk for damage or loss of the Product in transit.
- If the Product failure is not covered by this limited warranty, or proof of purchase does not meet the terms of this limited warranty, VTech will notify you and will request that you authorize the cost of repair and return shipping costs for the repair of Products that are not covered by this limited warranty.

What must you return with the Product to get warranty service?

1. Return the entire original package and contents including the Product to the VTech service location along with a description of the malfunction or difficulty;
2. Include "valid proof of purchase" (sales receipt) identifying the Product purchased (Product model) and the date of purchase or receipt; and
3. Provide your name, complete and correct mailing address, and telephone number.

Other Limitations

- This warranty is the complete and exclusive agreement between you and VTech. It supersedes all other written or oral communications related to this Product. VTech provides no other warranties for this product. The warranty exclusively describes all of VTech's responsibilities regarding the product.

There are no other express warranties. No one is authorized to make modifications to this limited warranty and you should not rely on any such modification.

State Law Rights: This warranty gives you specific legal rights, and you may also have other rights, which vary from state to state.

Limitations: Implied warranties, including those of fitness for a particular purpose and merchantability (an unwritten warranty that the product is fit for ordinary use) are limited to one year from date of purchase. Some states do not allow limitations on how long an implied warranty lasts, so the above limitation may not apply to you.

- In **no** event shall VTech be liable for any indirect, special, incidental, consequential, or similar damages (including, but not limited to lost profits or revenue, inability to use the product, or other associated equipment, the cost of substitute equipment, and claims by third parties) resulting from the use of this product, some states do not allow the exclusion or limitation of incidental or consequential damages, so the above limitation or exclusion may not apply to you.

FCC, ACTA, and IC Regulations

This equipment complies with Parts 15 of the Federal Communications Commission (FCC) rules for the United States. It also complies with regulations RSS210 and CS-03 of Industry and Science Canada. Operation is subject to the following two conditions: (1) this device may not cause interference, and (2) this device must accept any interference, including interference that may cause undesired operation of the device.

A label is located on the underside of the base unit containing either the FCC registration number and Ringer Equivalence Number (REN) or the IC registration number and Load Number. You must, upon request, provide this information to your local telephone company.

This equipment is compatible with inductively coupled hearing aids. Should you experience trouble with this telephone equipment, please contact:

FCC Part 15

Warning: Changes or modifications to this unit not expressly approved by the party responsible for compliance could void the user's authority to operate the equipment.

The equipment has been tested and found to comply with part 15 of the FCC rules. These limits are designed to provide reasonable protection against harmful interference in a residential installation. This equipment generates, uses and can radiate radio frequency energy and, if not installed and used in accordance with the instructions, may cause harmful interference to radio communications.

However, there is no guarantee that interference will not occur in a particular installation. If this equipment does cause harmful interference to radio or television reception, which can be determined by turning the equipment off and on, the user is encouraged to try and correct the interference by one or more of the following measures:

- Reorient or relocate the receiving antenna.
- Increase the separation between the equipment and receiver.
- Connect the equipment into an outlet or on a circuit different from that to which the receiver is connected.
- Consult the dealer or an experienced radio/TV technician for help.

To ensure safety of users, the FCC has established criteria for the amount of radio frequency energy that can be safely absorbed by a user or bystander according to the intended usage of the product. This product has been tested and found to comply with the FCC criteria. The handset has such a low power that it does not require testing. It may be safely held against the ear of the user. The base unit shall be installed & used such that parts of the user's body other than the hands should be maintained at a comfortable distance of approximately 20 cm or more.

IC (Industry Canada)

This telephone is registered for use in Canada.

The term "IC:" before the radio certification number only signifies that Industry Canada technical specifications were met.

FCC, ACTA, and IC Regulations

Notice:

This equipment meets the applicable Industry Canada Terminal Equipment Technical Specifications. This is confirmed by the registration number. The abbreviation, IC, before the registration number signifies that registration was performed based on a Declaration of Conformity indicating that Industry Canada technical specifications were met. It does not imply that Industry Canada approved the equipment.

Notice:

The Ringer Equivalence Number (REN) for this terminal equipment is 0.1. The REN assigned to each terminal equipment provides an indication of the maximum number of terminals allowed to be connected to a telephone interface. The termination on an interface may consist of any combination of devices subject only to the requirement that the sum of the Ringer Equivalence Numbers of all the devices does not exceed five.

Before installing this equipment, users should ensure that it is permissible to be connected to the facilities of the local telecommunications company. The equipment must also be installed using an acceptable method of connection. The customer should be aware that compliance with the above conditions may not prevent degradation of services in some situations.

Repairs to certified equipment should be made by an authorized Canadian maintenance facility designated by the supplier. Any repairs or alterations made by the user to this equipment, or equipment malfunctions, may give the telecommunications company cause to request the user to disconnect the equipment.

Users should ensure for their own protection that the electrical ground connections of the power utility, telephone lines and internal metallic water pipe system, if present, are connected together. This precaution may be particularly important in rural areas.

Caution:

Users should not attempt to make such connections themselves, but should contact the appropriate electrical inspection authority, or electrician, as appropriate.

Your cordless phone is designed to operate at the maximum power allowed by the FCC and IC. This means your handset and base unit can communicate only over a certain distance - which will depend on the location of the handset and base unit, weather, and the construction and layout of your home or office.

Technical Specifications

FREQUENCY CONTROL

Crystal controlled
PLL synthesizer

TRANSMIT FREQUENCY

Base: 5725 - 5850 MHz
Handset: 2400 - 2483.5 MHz

RECEIVE FREQUENCY

Base: 2400 - 2483.5 MHz
Handset: 5725 - 5850 MHz

CHANNELS

95 Channels

NOMINAL EFFECTIVE RANGE

Maximum power allowed by FCC and IC. Actual operating range may vary according to environmental conditions at the time of use.

SIZE

Handset: 182mm x 55.3mm x 40mm
(including antenna)
Charger: 76.5mm x 79.4mm x 45.2mm

WEIGHT

Handset: 146 grams
(excluding Battery)
Charger: 225 grams

POWER REQUIREMENTS

Handset: 3.6V @ 600mAh NiMH
Charger: 9 V DC @ 150mA

MEMORY

Phonebook: 50 Memory locations; up to 32 digits for number, 16 characters for name, per location.
CID: 50 memory locations

**SPECIFICATIONS ARE TYPICAL AND
MAY CHANGE WITHOUT NOTICE.**

Table Of Contents

IMPORTANT SAFETY INSTRUCTIONS	1
Parts Check List	3
The Handset Layout	4
GETTING STARTED	5
Set Up	5
Connecting Power to Handset Charger	5
Installation of Battery	5
Charging of the Handset Battery	6
IMPORTANT	6
Checking for Dial Tone	6
Registration	7
BASIC OPERATION	8
Handset Indicators	8
Handset Icons	8
Handset LED	8
ADVANCED OPERATION	9
Headset Operation	9
Belt Clip	9
ADDITIONAL INFORMATION	10
Maintenance	10
In Case Of Difficulty	11
Warranty Statement	12
FCC, ACTA, and IC Regulations	15
Technical Specifications	16

Congratulations on your purchase
of this VTech product

NEED HELP?

Our representatives are here
to help you with any questions
concerning the operation of this
product, available accessories,
or any other related issues.

Call Toll Free:

1-800-595-9511

In Canada, Call:

1-800-267-7377

or visit our website at
www.vtechphones.com

vtech

VTECH TELECOMMUNICATIONS LTD.

vtech A member of THE VTECH GROUP OF COMPANIES.

Distributed in the U.S.A. by VTech Communications, Inc. Beaverton, Oregon, 97008

Distributed in Canada by VTech Telecommunications Canada Ltd., Richmond, B.C.
V6X 1Z9.

Copyright 2005 for VTECH TELECOMMUNICATIONS LTD.
Printed in China

91-000296-010-000
ISSUE0