

## INTRODUCTION

Thank you for purchasing a **VTech** cordless telephone. This manual is designed to familiarize you with your **VT 2960**. To get the maximum use from your new phone, we suggest that you read this **Instruction Manual** before using your **VT 2960**.

Your **VTech VT 2960** is a two line, 900MHz, digital cordless phone with a Two-line Digital Answering System and, Speakerphone on the Base Unit. The **VT 2960** digitizes your voice using advanced ADPCM digital voice coding, providing noise and distortion free performance.

The **VTech VT 2960** also scrambles your voice before transmitting it between the Handset and Base Unit. This minimizes the possibility of surveillance by scanners and similar devices.

Your **VTech VT 2960** is Caller ID and Call Waiting-Caller ID compatible. The Handset LCD will display the name and phone number of the calling party, when available.

**NOTE: Caller ID and Call Waiting-Caller ID** are subscription services, available through most service providers. Contact your local telephone service provider for subscription information.

When the **VTech VT 2960** is not in use, you can easily answer a call on the Handset by pressing any key other than the OFF or Volume keys. This is very useful in a dark environment.

Your **VT 2960** provides one way Paging from the Base Unit to the Handset (very useful as a Handset locator), and a two way Intercom between the Handset and Base Unit.

The **VTech VT 2960** uses a non-volatile memory which is not susceptible to power failures. This feature provides permanent storage of all memory dial numbers, Caller ID records, as well as the Base Unit and Handset security codes.

The *optional* battery pack installed in the Base Unit provides operational backup in the event of a power failure. Calls can still be placed and received without interruption. About 5 hours of backup power is available with a fully charged battery pack in the Base Unit.

Your **VTech VT 2960** informs you when another phone on the same line is currently in use. The Handset will also alert you when you are Out of Range, whether or not the Handset is in use.

## INTRODUCTION

### ***SPECIAL FEATURES***

- 900MHz Operation
- Fully Digital Link between Handset and Base Unit with ADPCM voice coding for enhanced audio quality
- Digitally-Scrambled Voice Communication for call security
- Two-line Capability
- Alphanumeric Call Waiting Caller ID; Name and Number
- 50 CID memory capacity
- 2 Line Digital Answering System (for both lines).
- Base Unit Speakerphone
- 2 row by 12 character Multi-function LCD on Handset
- Conference Call Capability
- 10 Channel operation with Auto Channel Search and Select
- Backlit LCD and Keypad
- 20 Memory Dial locations
- Out-of-Range indication while Handset is On of Off Hook
- Removable Handset NiCad battery pack
- Spare Battery Charger in the Base Unit for optional battery pack
- Power Backup in the event of a power failure (with an optional spare battery pack installed in Base Unit)
- HOLD, FLASH, REDIAL functions
- Extension In Use indication
- Intercom/Page/Handset Locator
- Non-volatile memory of stored phone numbers and CID records
- Long-life NiCad Battery provides up to 7 hours of talk time or 7 days of standby
- Digital Volume Control
- Face-up Handset charging
- Easy Answer - When the phone rings, press any key other than the OFF or Volume keys on the Handset to answer
- Auto Hang-up when returning the Handset to the Base Unit cradle
- 24 Bit Digital Security Code provides 16.8 million combinations
- DTMF and Pulse dialing
- Low Battery detection and warning
- Programmable Ringer Types on Handset and Base Unit

## INTRODUCTION

### Parts Check List

1. Base Unit, Handset and AC Adaptor
2. Longer Two-Line Telephone Cords
3. Shorter Telephone Cord(for mounting)
4. Battery Pack
5. Wall mount bracket
6. Belt-clip

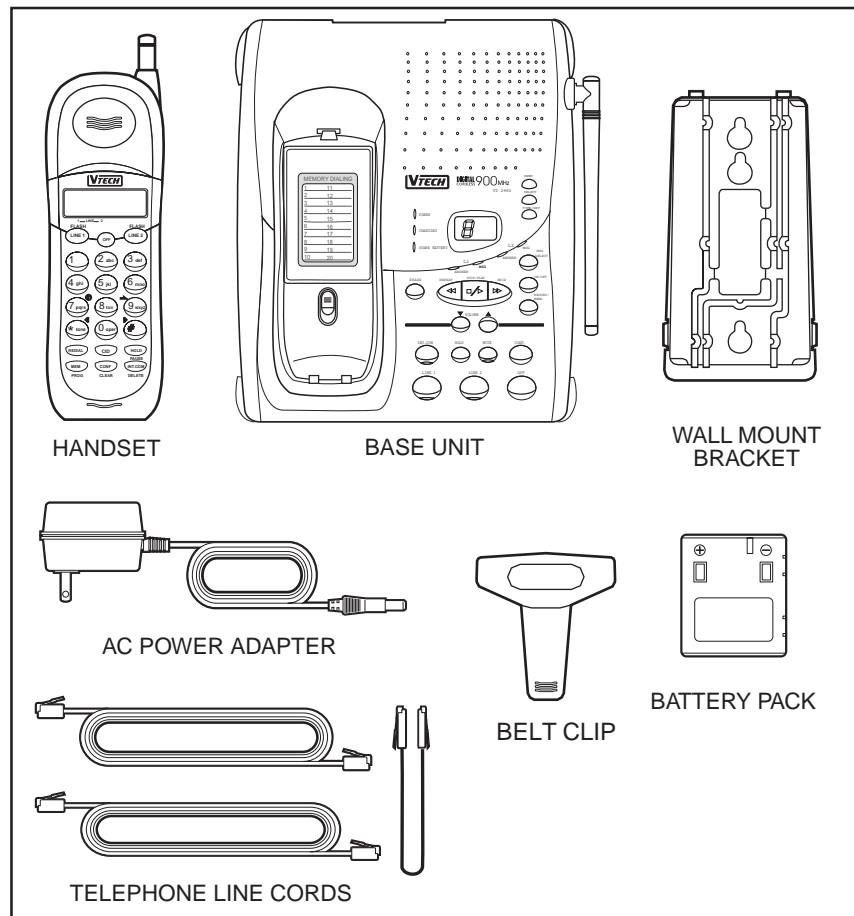

To purchase additional Battery Packs,  
call VTECH Communications at 1-800-595-9511.  
In Canada, call VTECH Electronics at 1-800-267-7377.

## IMPORTANT SAFETY INSTRUCTIONS

### Important Safety Instructions

When using your telephone, please follow these basic safety precautions to reduce the risk of fire, electric shock or injury to persons:

- I. Read and understand all instructions.
- II. Follow all warnings and instructions marked on the product.
- III. Unplug this product from the wall outlet before cleaning. Do not use liquid cleaners or aerosol cleaners. Use a damp cloth for cleaning.
- IV. Do not use this product near water (for example, near a bath tub, kitchen sink, or swimming pool).
- V. Do not place this product on an unstable cart, stand, or table. The product may fall, causing serious damage to the product.
- VI. Slots and openings in the cabinet and the back or bottom are provided for ventilation. To protect it from overheating, these openings must not be blocked by placing the product on a bed, sofa, rug, or other similar surface. This product should never be placed near or over a radiator or heat register. This product should not be placed in a built-in installation where proper ventilation is not provided.
- VII. This product should be operated only from the type of power source indicated on the marking label. If you are not sure of the type of power supply to your home, consult your dealer or local power company.
- VIII. Do not allow anything to rest on the power cord. Do not locate this product where the cord will be abused by persons walking on it.
- IX. Never push objects of any kind into this product through cabinet slots as they may touch dangerous voltage points or short out parts that could result in a risk of fire or electric shock. Never spill liquid of any kind on the product.
- X. To reduce the risk of electric shock, do not disassemble this product. If service or repair work is required, contact VTech Customer Service at 1-800-595-9511 in the U.S. or 1-800-267-7377 in Canada. Opening or removing cabinet parts other than specified access doors may expose you to dangerous voltages or other risks. Incorrect reassembling can cause electric shock when the appliance is subsequently used.
- XI. Do not overload wall outlets and extension cords as this can result in the risk of fire or electric shock.

## **IMPORTANT SAFETY INSTRUCTIONS**

- XII. Unplug this product from the wall outlet :
- A. When the power supply cord or plug is damaged or frayed.
- B. If liquid has been spilled into the product.
- C. If the product has been exposed to rain or water.
- D. If the product does not operate normally by following the operating instructions. Adjust only those controls that are covered by the operating instructions, because improper adjustment of other controls may result in damage and will often require extensive work to restore the product to normal operation.
- E. If the product has been dropped and the cabinet has been damaged.
- F. If the product exhibits a distinct change in performance.
- XIII. Avoid using a telephone (other than a cordless type) during an electrical storm. There may be a remote risk of electric shock from lightning.
- XIV. Do not use the telephone to report a gas leak in the vicinity of the leak.

**SAVE THESE INSTRUCTIONS**

## RECHARGEABLE BATTERY PACKS

### **Charging the Handset batteries**

The Handset of your **VTech 2960** cordless telephone is powered by a rechargeable battery pack. It charges automatically whenever the Handset is in the Base Unit cradle. You should charge the battery pack for 16 hours when you first receive your phone. You will know the battery pack needs charging when:

- The phone emits a warning tone when you press the a Line key.
- The "LOW BATTERY" message is displayed on the LCD:



- The Handset seems completely dead, the LCD is clear and the Handset does not beep when you press the keys.

### **To Charge The Battery Pack**

To charge the battery pack, first install battery pack in the Handset, then place the Handset in the Base Unit. The **CHARGE** indicator will light to show the Handset is seated properly and the battery pack is charging. It is recommended that the battery pack be charged for at least 16 hours initially and 8 hours for maintenance charging. You can use your telephone before that with diminished capacity, but it is best to charge the battery pack fully. It will take several recharge cycles to maximize the charge capacity of your battery pack. The maximum battery life between charges is 7 hours of continuous talk time or 7 days of standby time.

### **Spare Battery Charger**

Alternatively, if you have purchased a spare battery pack and it has been charging in the base unit, simply exchange the drained Handset battery pack with the fully charged replacement battery pack from the spare battery charger. Place the drained Handset battery pack into the spare battery charger so it will charge.

The base spare battery charger does NOT charge a battery pack as quickly as the main Handset charger. A full charge requires 24 hours.

### **A Word About Rechargeable Batteries**

Your NiCad battery pack recharges whenever the Handset is returned to the Base Unit.

### **IT'S IMPOSSIBLE TO OVERCHARGE**

The battery pack can be recharged many times but if you get a low battery signal even after 8 hours of maintenance charging in the base cradle (or 24 hours in the spare battery charger), the battery pack(s) should be replaced.

To purchase additional Battery Packs, call VTECH Communications at 1-800-595-9511. In Canada, call VTECH Electronics at 1-800-267-7377.

## RECHARGEABLE BATTERY PACKS

### Replacing The Handset Battery Pack

1. Remove the battery cover by pressing on the ridged lines and sliding downward.

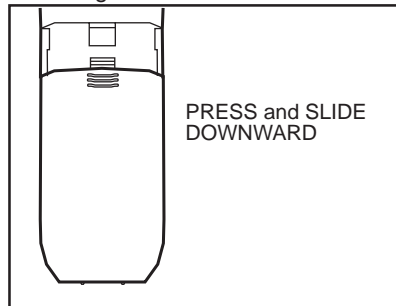

2. Discard the old battery pack. Don't put the old battery pack in a trash compactor or a fire - it could burst.

**IMPORTANT:** Do not dispose of this battery in household garbage. For information on recycling or proper disposal, consult your local solid waste collection or disposal organization.

3. Place the new battery pack in the battery compartment. Make sure the metal contacts on the underside of the battery are aligned with the charging contacts in the battery compartment.

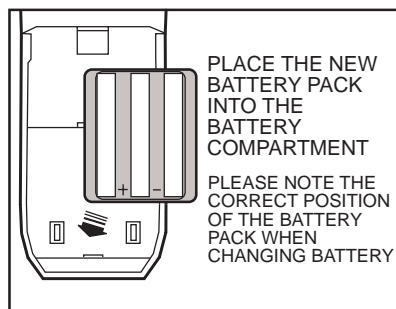

4. The new battery pack must be charged before using your telephone. Place the Handset in the cradle of the Base Unit and allow it to charge for 16 hours.

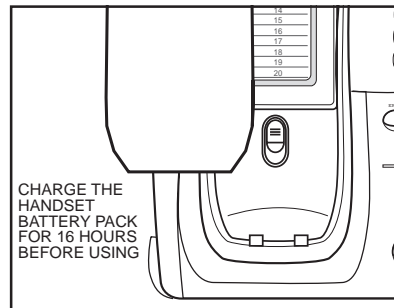

**CAUTION:** To reduce the Risk of Fire or Injury to Persons, Read and Follow these Instructions:

1. Use only VTECH battery.
2. Do not open or mutilate the battery. Released electrolyte is corrosive and may cause damage to the eyes or skin. It may be toxic if swallowed.
3. Exercise care in handling the battery pack in order not to short the battery with conducting materials such as rings, bracelets, and keys. The battery or conductor may overheat and cause burns.
4. Do not dispose of the battery in a fire. The cell may explode.

To order replacement batteries, contact **VTech Customer Service** at **1-800-595-9511** in the U.S. or **1-800-267-7377** in Canada.

## WALL MOUNTING

The Wall Mount bracket is designed to fit on standard Wall Mount plates.

**1. Choose a spot near an electrical outlet and a telephone jack.**

Your phone requires a modular telephone jack and a standard electrical outlet (120v AC). The power cord is six feet long; make sure there is an electrical outlet within reach of the Base. The outlet should not be controlled by a wall switch. If the switch is ever turned off, the phone will not operate. (Unless you have a power back-up battery)

**2. Position the wall mounting bracket on the Base.**

Line up the tabs on the wall mounting adaptor with the holes on the bottom of the base (Figure 1). Snap the wall mounting adaptor firmly in place.

**3. Mount the Base on the wall.**

Position the Base so the mounting studs will fit into the holes on the bottom of the Base. Position the power cord to extend down the wall the phone is to be mounted on. Slide the base down on the mounting studs until it locks into place.

**4. Connect the telephone cord.**

The telephone line cord has a snap-in plug at each end. Insert one of the plugs into the jack on the back of the Base. Insert the other end of the plug into the wall jack.

**5. Plug the AC adaptor into an electrical outlet and the DC connector into the power jack located on the back of the Base Unit (Figure 2).**

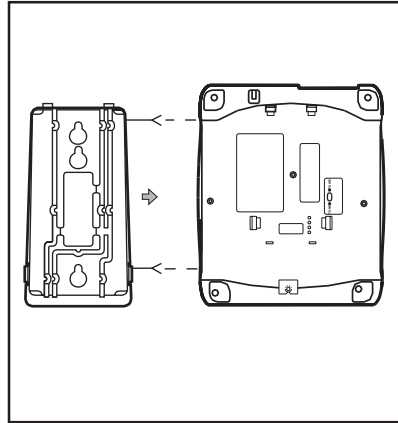

Figure 1

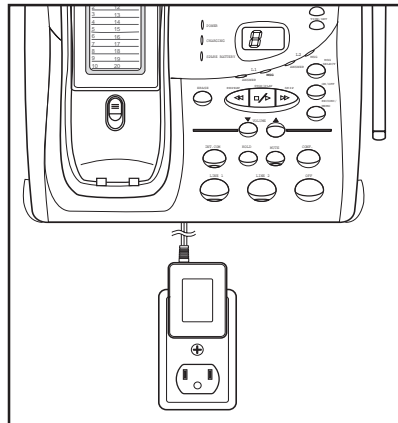
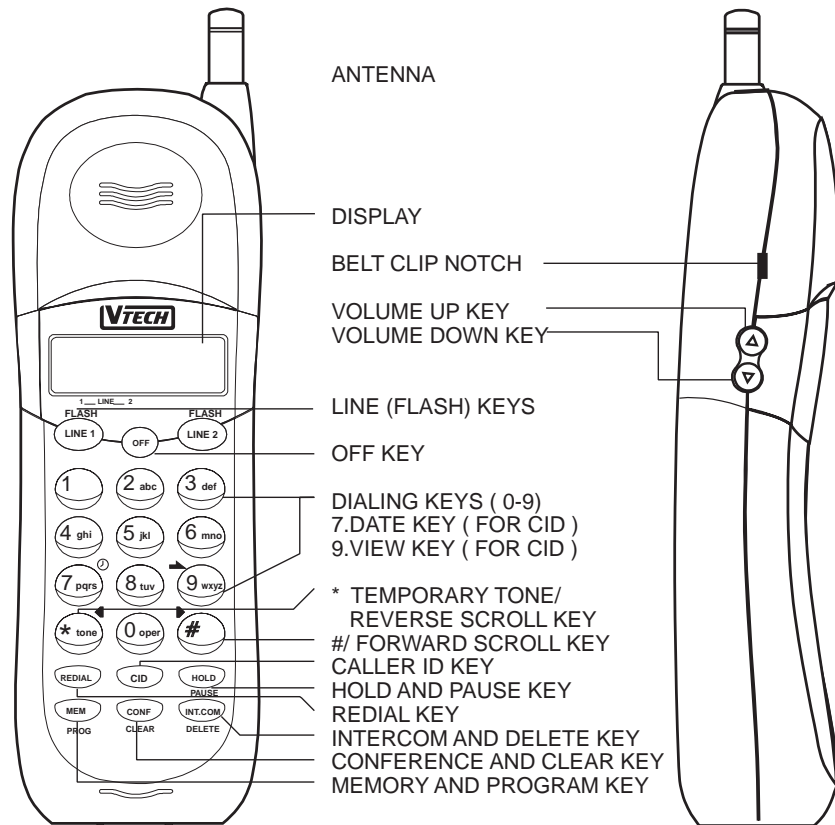

Figure 2

# HANDSET FEATURES

## HANDSET FEATURES



## HANDSET FEATURES

### **LINE 1 KEY**

Press this key to select LINE 1.

If the Handset has already accessed LINE 1, pressing this key will **FLASH** the line.

If LINE 1 is on HOLD, pressing this key will take LINE 1 off HOLD and return you to your call.

If LINE 2 is IN USE, or you are in CONFERENCE mode, pressing this key access LINE 1 and put LINE 2 on HOLD.

If you are reviewing CID records, pressing this key will dial the contents (last 7 digits) of the record displayed on the LCD.

### **LINE 2 KEY**

Press this key to select LINE 2.

If the Handset has already accessed LINE 2, pressing this key will **FLASH** the line.

If LINE 2 is on HOLD, pressing this key will take LINE 2 off HOLD and return you to your call.

If LINE 1 is IN USE, or you are in CONFERENCE mode, pressing this key access LINE 2 and put LINE 1 on HOLD.

If you are reviewing CID records, pressing this key will dial the contents (last 7 digits) of the record displayed on the LCD.

### **OFF KEY**

Press this key to end your call.

Press this key to exit from MEMORY DIALING, CID, or any programming mode.

In CONFERENCE mode, pressing this key will disconnect **both** lines.

### **\*TONE KEY**

From the PULSE (rotary) dialing mode, press this key to switch to TEMPORARY TONE mode.

When the call is ended, the phone will return to PULSE dialing mode.

### **MEM/PROG (MEMORY/PROGRAM) KEY**

With the Handset OFF, press this key for less than 1 second to enter MEMORY DIALING mode.

With the Handset OFF, press and hold this key for more than 1 second to enter PROGRAMMING mode. Both MEMORY DIAL phone numbers and ringer types for the Handset and Base Unit are programmable by the user.

### **CALLER ID (CID) KEY**

Press this key to display CALLER ID records. While you're in the CALLER ID mode, press the \* ( ◀ ) and # ( ▶ ) keys to scroll through the records.

Press this key a second time to display the phone number associated with the currently displayed CID record. The local (last 7 digits) phone number will be displayed.

## HANDSET FEATURES

### **REDIAL KEY**

Press this key to display and/or dial the last number you called.

When the Handset is On (with dial tone), press this key to dial the last number called.

When the Handset is Off, pressing this key will display the last dialed phone number on the LCD. You can then press a LINE key, and the displayed number will be dialed. If you do not wish to dial, press OFF to exit the REDIAL mode.

### **HOLD/PAUSE KEY**

Press this key when the Handset is on one or both lines to place the call(s) on Hold.

Press the appropriate Line key to cancel Hold. If both lines are on Hold, press the CONF/CLEAR key to cancel Hold and return to the Conference Call.

NOTE: Pressing **OFF** or **HOLD/PAUSE** will not cancel Hold.

Press this key to insert a 2 second pause as you program phone number into MEMORY DIALING. See *TO STORE A NUMBER INTO MEMORY*.

### **CONFERENCE/CLEAR (CONF/CLEAR) KEY**

Press this key to CONFERENCE a call on LINE 1 and a call on LINE 2 simultaneously. To enter CONFERENCE mode, the Handset must be in one of the following conditions.

1. LINE 1 is on a call and LINE 2 is on HOLD
2. LINE 2 is on a call and LINE 1 is on HOLD
3. Both lines are on HOLD.

NOTE: While in CONFERENCE mode, MEMORY DIALING numbers and CID records **cannot** be accessed.

While the Handset is Off, press this key for more than 1 second to clear the LCD display. This is helpful if you should misdial during MEMORY programming.

While in CID or MEMORY DIALING mode, press this key for more than 1 second to delete the entire contents of the list you're examining. The LCD will prompt you to press the **INT.COM/DELETE** key to confirm your decision.

### **INT.COM/DELETE (INTERCOM/DELETE) KEY**

While the Handset is Off or when a line is on Hold, press this key to enter the INTERCOM mode with the Base Unit. Press **OFF** to exit the INT.COM mode.

While the Handset is Off, press and hold this key for more than 1 second to delete the last digit entered, as reflected by the LCD display. This is comparable to a Backspace function on a keyboard. If you continue to hold the **INT.COM/DELETE** key, the backspace function will continue.

## HANDSET FEATURES

While you are reviewing CID or MEMORY DIALING records, press and hold this key to delete the record currently displayed. The LCD will confirm deletion.

### **VOLUME CONTROL KEY**

Located on the edge of the Handset opposite the antenna, this key controls the earpiece volume.

Press and hold the ▲ portion of the key to raise the volume.

Press and hold the ▼ portion of the key to lower the volume.

The Handset LCD will display the volume level as you adjust it. One bar indicates the minimum volume level; 4 bars indicates the maximum.

The **VT 2960** is also equipped with a detachable belt clip. Align the pins on the inside edge of the belt clip with the notches on the inside of the **VT 2960** Handset. The belt clip should snap securely into place. Do not force the connection. See illustration:

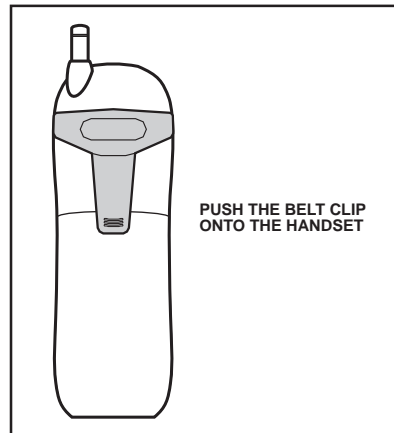

# EXAMPLES OF THE LCD DISPLAY



The handset has accessed LINE 1



The handset has accessed LINE 2



The Base Unit has accessed LINE 1



The handset has accessed LINE 1, while the Base Unit has accessed LINE 2



Both handset and Base have accessed LINE 1



Current Handset volume level



Handset battery requires recharging



Handset has entered INTERCOM



Base Unit is attempting to contact Handset via INTERCOM key



LINE 1 on hold



LINE 2 on hold



Extension phone is using LINE1



Extension phone is using LINE2



Handset is in Conference mode with LINES 1 & 2



Base Unit is in Conference mode with LINES 1 & 2



Both Handset and Base Unit is in Conference mode with LINES 1 & 2

## EXAMPLES OF THE LCD DISPLAY

PROGRAM  
LOCATION \_ \_

Handset is asking for 2-digit location during Memory Dial programming

PROGRAMMING  
INCOMPLETE

A mistake was made during Memory Dial programming

SPEED DIAL  
LOCATION \_ \_

Enter a 2-digit location for Memory (Speed) Dialing

LOCATIONXX  
DELETED

The contents of a Memory Dial location have been deleted

CHANNEL  
SEARCHING ...

The Handset has lost communication with the Base Unit, and is attempting to re-link

FOUND  
CHANNEL X

The Handset has reestablished contact with the Base Unit

CALL DROPPED

The Handset could not regain contact with the Base Unit, and has dropped the call

ABC COMPANY  
503-6438981 

Example of alphanumeric CID display when a call comes in

503-6438981  
8:30A AUG31

Press & hold 7 key while reviewing CID records to view the phone # and when it came in

CALL # 15   
ABC COMPANY

Scrolling through the CID records, this displays the caller's name, CID location, and LINE

ABC COMPANY  
INC

Press & hold 9 key while reviewing CID records to view additional letters of the name

CALL # 15   
503-6438981

CID record if you subscribe to **number-only** Caller ID

DELETING  
SINGLE CALL

You have deleted a single CID record

DELETING  
ALL CALLS

You have deleted **all** CID records

## EXAMPLES OF THE LCD DISPLAY

LOCATION 13  
5036438981

The contents of Memory Dial location #13

LOCATION 15  
DELETED

You have deleted Memory Dial location #15

DELETE ALL?  
DEL TO ALLOW

To prevent accidental deletions of all CID records or Memory Dial locations, this message prompts you to confirm your decision

DELETING ALL  
LOCATIONS

Confirms mass deletion of all CID records or Memory (Speed) Dial locations

?: 1=HANDSET  
2=BASE

During Ringer programming, you are prompted to select Handset or Base Unit ringer

?: 1=LINE 1  
2=LINE 2

During Ringer programming, you are prompted to select a LINE

HANDSET 1  
RINGER 1

Example of the LCD as you select a ringer type

UNAVAILABLE  
UNAVAILABLE

The name and number of the caller are unavailable as the call comes in

PRIVATE  
PRIVATE

As the phone rings, this indicates that the caller has blocked CID information

CALL # 01 1  
UNAVAILABLE

As you review CID records, this indicates that the name and/or phone number is unavailable

CALL # 02 1  
PRIVATE

As you review CID records, this indicates that the calling party has blocked CID information

TRANSMISSION  
ERROR

Incoming Caller ID data was incomplete

12 NEW CALLS

12 new calls have been received since you last reviewed CID records

# BASE UNIT FEATURES

## BASE UNIT FEATURES

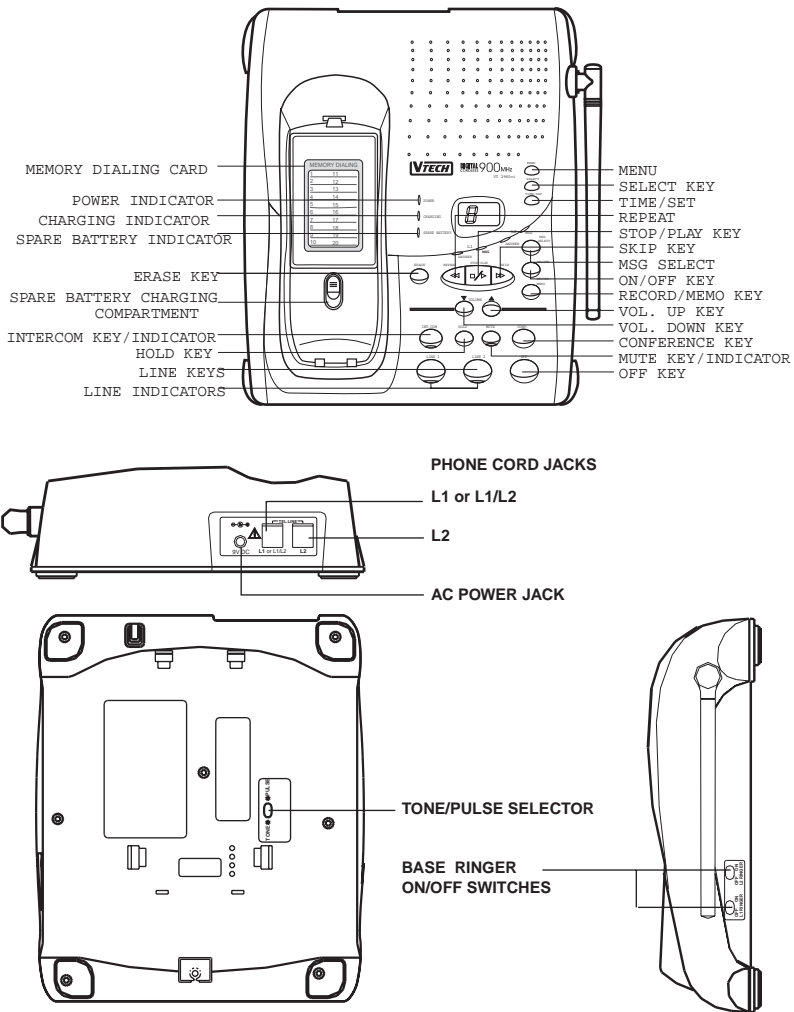

## BASE UNIT FEATURES

### BASE LED INDICATORS

#### POWER LED

Glow when the AC adaptor is supplying power to the Base Unit.

#### CHARGE LED

Glow when the Handset is placed in the Base Unit cradle to charge.

#### SPARE BATTERY LED

Glow when the (optional) battery pack is installed in spare battery compartment in the Base Unit.

#### INTERCOM LED

Glow when the Base Unit has entered the INTERCOM mode with the Handset.

#### MUTE LED

Glow when the **MUTE** key has been pressed, indicating that the Base Unit microphone has been temporarily disabled.

#### LINE 1 (EXTENSION IN USE) LED

Glow steadily when the Base Unit is accessing LINE 1.

Flashes slowly when only the Handset or an extension phone is accessing LINE 1.

Flashes rapidly when LINE 1 is placed on HOLD.

Flashes in cadence with the incoming ring when you receive a call.

#### LINE 2 (EXTENSION IN USE) LED

Glow steadily when the Base Unit is accessing LINE 2.

Flashes slowly when only the Handset or an extension phone is accessing LINE 2.

Flashes rapidly when LINE 2 is placed on HOLD.

Flashes in cadence with the incoming ring when you receive a call.

#### LINE 1 KEY

Press this key to access or FLASH LINE 1.

During CONFERENCE mode, pressing this key will maintain access to LINE 1 while placing LINE 2 on HOLD.

#### LINE 2 KEY

Press this key to access or FLASH LINE 2.

During CONFERENCE mode, pressing this key will maintain access to LINE 2 while placing LINE 1 on HOLD.

#### OFF KEY

Press this key to disconnect the Base Unit during any of the following conditions:

1. The Base Unit is on LINE 1 **or** 2
2. The Base Unit is CONFERENCEING LINES 1 **and** 2
3. The Base is in INTERCOM mode.

NOTE: Pressing this key affects the Base Unit only. Also, pressing **OFF** will **not** disconnect a call which the Base Unit has placed on HOLD.

## BASE UNIT FEATURES

### **CONF KEY**

Press this key to conference LINE 1 and LINE 2.

### **HOLD KEY**

Press this key to place your call on HOLD.

Press the appropriate LINE key to cancel HOLD.

In CONFERENCE mode, press this key to place **both** lines on HOLD. Press **CONF** to cancel HOLD.

### **MUTE KEY**

Press this key to disable the Base Unit microphone during a call (or during INT.COM mode). Press this key again to cancel MUTE.

### **INTERCOM (INT. COM) KEY**

Press this key to page the Handset. If the Handset user responds by pressing **INT. COM**, the **INTERCOM** LED on the Base Unit will glow and the 2 parties can now talk. The Handset user can also choose to terminate the page by pressing **OFF**.

Press **OFF** to exit from the INTERCOM mode.

This feature can be used as a Handset locator. The Handset will ring a maximum of 5 times, giving you an opportunity to find it.

### **VOLUME UP & DOWN KEYS**

Press these keys to raise and lower the Speakerphone volume level. You can hold a key down to achieve maximum (or minimum) volume.

### **RINGER ON/OFF SWITCHES**

Located on the right edge of the Base Unit (antenna side), these switches control the Base Unit ringer for each line. These switches have no effect on the Handset ringers.

### **STONE/PULSE SWITCH**

Located on the underside of the Base Unit, set this switch to the dialing mode compatible with your local telephone service. For most areas, **STONE** is the preferred dialing mode.

## GETTING STARTED

### Setting up your VTech VT 2960

1. Choose an area near an electrical outlet and telephone wall jack(s).
2. Plug the AC power adaptor into the electrical outlet and the DC connector to the back of the Base Unit.

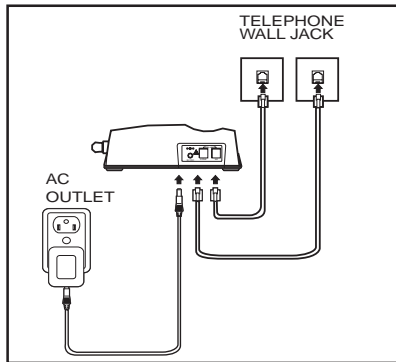

**CAUTION:** Use only the AC adaptor shipped with your VT 2960. This is a Class 2 AC adaptor, specifically designed for use with your telephone.

3. Set the **TONE/PULSE** switch, located on the underside of the Base Unit. Select the mode compatible with your local telephone service (for most areas, TONE is the preferred dialing mode).
4. Set the Base Unit **RINGER** switches to ON or OFF, depending on your preference.
5. **CHARGE THE HANDSET BATTERY PACK BEFORE USE.** The battery pack should be charged for **16 hours** before using your phone for the first time.

**NOTE:** Connect power to the Base Unit before placing the Handset into the cradle.

6. Connect the telephone line cords:

**If you have 2 telephone lines installed on a single jack (type RJ-14),** use the 2-line cord provided. This is a 4 wire cord. Plug one end of this cord into the jack marked **L1 or L1/L2**, located on the back edge of the Base Unit. Plug the other end of this cord into your 2-line wall jack.

**If you have 2 separate telephone line jacks (2 RJ-11 jacks),** plug one telephone line cord into the jack marked **L1 or L1/L2**, and another cord into the jack marked **L2**. In this situation, it does not matter which line cord you choose for each line. Plug the other end of the 2 line cords into your separate wall jacks.

**NOTE:** For two line operation, you must have 2 telephone lines, each with their own unique phone number. If you have only one telephone line, your **VT 2960** will still operate, but only as a single line phone.

7. **CHECK FOR DIAL TONE.** After the battery pack is charged, raise the Base Unit Antenna to an upright position. Then, pick up the Handset and press **LINE 1** or **LINE 2**. The LCD should display **HANDSET ON 1 (or 2)**, and you should hear a dial tone. If you do not hear a dial tone, there may be a problem with the telephone jack or the wiring. See **IN CASE OF DIFFICULTY**.

## BASIC OPERATIONS

### **MAKING CALLS**

**Extend the Antenna whenever you remove the Handset from the Base Unit cradle**

**There are two ways to make a call:**

- Press **LINE 1/FLASH** or **LINE 2/FLASH** and listen for dial tone. The LCD will display **HANDSET ON 1 (or 2)**. Dial the phone number.

**OR**

- With the Handset OFF, dial the phone number. Then, press the desired **LINE** key. After a 2 second delay to access dial tone, the phone number you entered will automatically be dialed.

**NOTE:** If you make a mistake while entering digits (with the Handset OFF), press and hold the **INT.COM/DELETE** key. The LCD will begin to delete digits, one by one, until you release the key.

If you want to delete ALL digits at once, press and hold the **CONF/CLEAR** key. All previously entered digits will be deleted, and the LCD will be blank.

To end your call, press **OFF**, or return the Handset to the Base Unit cradle.

**To put a call on HOLD from the Handset:**

Press the **HOLD/PAUSE** key to place a call on HOLD.

Press the appropriate **LINE** key to cancel HOLD and return to the conversation.

If you are on LINE 1 and press **LINE 2**, LINE 1 will automatically go into HOLD mode. Press **OFF** to end your call with LINE 2, then press **LINE 1** to return to your party on LINE 1. Otherwise, with LINE 1 on HOLD and LINE 2 active, press **CONF/CLEAR** to enter CONFERENCE mode.

If you are on LINE 2 and press **LINE 1**, LINE 2 will automatically go into HOLD mode. Press **OFF** to end your call with LINE 1, then press **LINE 2** to return to your party on LINE 2. Otherwise, with LINE 2 on HOLD and LINE 1 active, press **CONF/CLEAR** to enter CONFERENCE mode.

To end a 2-Line CONFERENCE, press **OFF**.

**NOTE:** You **cannot** end a call when it is on HOLD. First, press the appropriate LINE key, then press **OFF** (or return the Handset to the Base Unit cradle).

### **REDIAL**

Press the appropriate **LINE** key and listen for dial tone. Then press **REDIAL**. The most recent phone number you called will automatically be redialed.

Similar to **Making Calls** above, you can also press **REDIAL** with the Handset OFF, and then press the desired **LINE** key. The **VT 2960** will wait 2 seconds for a dial tone, and then **REDIAL** the last number you called.

## BASIC OPERATIONS

### ANSWERING CALLS FROM THE HANDSET

**Extend the Antenna whenever you remove the Handset from the Base Unit cradle.**

In addition to the audible ringer, a flashing arrow in the lower portion of the Handset LCD will indicate which line is receiving an incoming call.

*With the Handset OFF:* When the phone rings, press **any** key other than the OFF or Volume keys.

*With the Handset IN USE* (one line is active): If you are on a call on either line, the Handset will emit a single alert signal through the earpiece to warn you that someone is attempting to reach you on the unoccupied line. You may now do the following:

1. Press **OFF** to end your first call, then press **any** key other than the OFF or Volume keys to answer the new call.

**OR**

2. Press the **LINE/Flash** key to answer the incoming call. Your original call will be placed on HOLD. To join both lines in CONFERENCE mode, press the **CONF/CLEAR** key. To end a 2-Line conference call, press the **OFF** key.

See the section **CONFERENCE CALLS** for more details.

**NOTE:** You cannot end a call which has been placed on HOLD unless you first press the appropriate **LINE** key to take the call off HOLD, and then press **OFF** (or return the Handset to the Base Unit).

### ANSWERING CALLS FROM THE BASE UNIT (SPEAKERPHONE)

In addition to the audible ringer, the LINE LED flashes in cadence with the incoming ring signal to indicate an incoming call.

With the Base Unit OFF: When the phone rings, press the appropriate **LINE** key.

Press **OFF** to end your call.

*With the Base Unit IN USE* (one line is active): If you are on a call on either line, and a call comes in on the unoccupied line, you can:

- Press **OFF** to end your original call, then press the appropriate **LINE** key to answer the incoming call;

**OR**

- Press the appropriate **LINE** key to answer the incoming call. Your original call will be placed on HOLD. You can now join both lines in CONFERENCE mode by pressing **CONF**. Press **OFF** to end your conference call.

See the section **CONFERENCE CALLS** for more details.

**NOTE:** You cannot end a call which has been placed on HOLD unless you first press the appropriate **LINE** key to take the call off HOLD, and then press **OFF**.

## BASIC OPERATIONS

**NOTE:** If you use the Speakerphone in an environment that is not very quiet, your caller's voice may fade in and out. Should this occur, press the **MUTE** key before your party begins to speak, then press **MUTE** again (to turn MUTE off) when it's your turn to speak.

### **CALL WAITING**

If you receive a CALL WAITING tone while you are on a call, press the appropriate **LINE/Flash** key to switch from your current call to the new caller.

Press the **LINE/Flash** key again to return to the original call.

**NOTE:** *CALL WAITING* is a subscription service from your local telephone service provider. Contact your provider for ordering information.

### **SWITCHING FROM HANDSET TO BASE OR BASE TO HANDSET**

#### **Switching from Handset to Base Unit Speakerphone**

If you are on a call using the Handset, and want to switch to the Base Unit Speakerphone for hands-free conversation, do the following:

1. Press **HOLD** on the Handset.
2. Press the appropriate **LINE** key on the Base Unit to resume your conversation.

#### **Switching from Speakerphone to Handset**

If you are on a Speakerphone call, and want to switch to the Handset:

1. Press **HOLD** on the Speakerphone.
2. Press the appropriate **LINE/Flash** key on the Handset to resume your conversation.

**NOTE:** The Handset and Speakerphone can both be on the same call at the same time.

### **INTERCOM/PAGE**

The Handset and Base Unit can be used as an INTERCOM when **1)** neither line is active, or **2)** all calls are placed on HOLD.

The INTERCOM feature allows 2-way conversation between the Handset and Base Unit. It also serves as a **PAGE/FIND** feature. By pressing **INT.COM** on the Base Unit, the Handset will ring **5** times, alerting the Handset user, or allowing you the opportunity to find the Handset, in the event it is misplaced.

## BASIC OPERATION

### Base Unit Paging Handset

When the **INT.COM** key is pressed on the Base Unit, the Handset will ring differently than its incoming call ring. The LCD will display **BASE PAGING HANDSET**, as well. The Handset user can then do the following:

- Press **INT.COM**. The Base Unit and Handset are now in INTERCOM mode.

OR

- Press **OFF**. The alerting ring will stop.

OR

- Let the ringing continue. It will stop after **5** rings.

### Handset Paging Base Unit

When the **INT.COM** key is pressed on the Handset, the Base Unit rings **once**, and then automatically enters INTERCOM mode. The person at the Base Unit does not need to press any keys to respond to the Handset.

While in INTERCOM mode, either party can press **OFF** to terminate this feature.

If a call comes in while your **VT 2960** is in INTERCOM mode, the Handset and Base Unit will ring normally. Once the appropriate **LINE** key is pressed on either component, you will be connected with the caller, and the INTERCOM mode is terminated.

## ADVANCED OPERATIONS

### CONFERENCE CALLS

This feature allows you to link both lines together for a 3-way conversation between you and the parties on LINE 1 and LINE 2. Conference calls can take place from the Handset or the Base Unit.

### To Conference both lines:

1. Place the original call on HOLD by pressing the **LINE/Flash** key corresponding to the unoccupied LINE (either to make a call or answer an incoming call).
2. Once you have connected with your second party, while the original call remains on HOLD, press **CONF/CLEAR**. You are now linked to both lines.
3. To end your conference call, press **OFF**.

### Conference Call Tips:

While in CONFERENCE mode, pressing **HOLD** will place both lines on HOLD. Press **CONF** again to return to your conference call.

While in CONFERENCE mode, if you want to disconnect one line **only**, do the following:

1. Press the **LINE** key corresponding to the LINE you wish to disconnect. The other line will be placed on HOLD.
2. Press **OFF**.
3. Press the appropriate **LINE** key to return to the remaining call.

If the Handset is in CONFERENCE mode, the Base Unit can join the call.

If the Base Unit is in CONFERENCE mode, the Handset can join the call.

For example: If the Handset is in CONFERENCE mode, and someone at the Base Unit wants to join the conversation, press either **LINE** key on the Base Unit. The Base Unit has now entered CONFERENCE mode.

When both the Handset and the Base Unit are in CONFERENCE mode, pressing **OFF** on either unit does not hang up the lines. It only turns the particular unit OFF. **OFF** needs to be pressed on both the Handset **and** Base Unit to end your 4-Way conference call.

### PROGRAMMING THE RINGER

The **VT 2960** Handset and Base Unit are capable of four different types of ringer tones for each line. In addition, you can turn the ringer OFF. The following sections detail how to program the Base Unit and Handset ringers.

### Programming the Handset Ringer

1. Press and hold the **MEM/PROG** key until the LCD displays **PROGRAM LOCATION \_ \_**.
2. Press **#**. LCD displays **?: 1=HANDSET 2=BASE**.
3. Press **1**. LCD displays **?:1=LINE1 2=LINE 2**.
4. Press **1** (or **2**, depending on which line you're programming).
5. Press **1,2,3,4**, or **0** (ringer OFF). The Handset will generate the tone you've selected. Press any of the other ringer selections (1,2,3,4) to compare the different tones.
6. Once you have selected a ringer tone, press **OFF**.

## ADVANCED OPERATIONS

### Programming the Base Unit Ringer

1. Press and hold the **MEM/PROG** key until the LCD displays **PROGRAM LOCATION** \_\_.
2. Press **#**. LCD displays **?: 1=HANDSET 2=BASE**.
3. Press **2**. LCD displays **?: 1=LINE 1 2=LINE 2**.
4. Press **1** (or **2**, depending on which line you're programming).
5. Press **1,2,3**, or **4**. The Base Unit will generate the tone you've selected. Press any of the other ringer selections (1,2,3,4) to compare the different tones.
6. Once you have selected a ringer tone, press **OFF**.

To turn the Base Unit ringer OFF, locate the **L1 RINGER** and **L2 RINGER ON/OFF** switches, on the right-hand edge (antenna side) of the Base Unit.

**NOTE:** Adjusting the Base Unit ringer switches does **not** affect the Handset ringer settings.

### MEMORY DIALING

Your **VT 2960** can store **20** phone numbers in memory. Each phone number can contain up to 20 digits.

### Programming Phone Numbers into Memory

1. With the Handset OFF, enter the telephone number you wish to store. View the number on the LCD to make sure you've entered it correctly. If you've made a mistake, either press and hold the **CONF/CLEAR** key to erase the entire string of numbers, or press and hold the **INT.COM/DEL** key, which will backspace your entry, one digit at a time.

2. Press and hold **MEM/PROG**. The LCD displays **PROGRAM LOCATION** \_\_.
3. Enter a 2-digit memory location (01 - 20). The Handset will emit a warbled, happy tone to confirm successful programming.

If the LCD displays **PROGRAMMING INCOMPLETE**, repeat **STEPS 1-3**.

### Storing a Phone Number from REDIAL

1. With the Handset OFF, press **REDIAL**. The last phone number you called will be displayed on the LCD.
2. Press and hold **MEM/PROG**. The LCD displays **PROGRAM LOCATION** \_\_.
3. Enter a 2-digit memory location (01-20). The Handset will emit a warbled, *happy tone* to confirm successful programming.

### Storing a Pause in a Phone Number

To insert a pause when programming a phone number into memory, press the **HOLD/PAUSE** key at the appropriate point in the number sequence. A **P** will be displayed on the LCD, and is treated as a stored digit. The pause is approximately 2 seconds. For a longer pause, press **HOLD/PAUSE** two or more times.

For example, to store 9-PAUSE-555-1234 in Memory Location **08**:

1. Press **9**
2. Press **HOLD/PAUSE**
3. Enter 5551234
4. Press and hold **MEM/PROG**
5. Enter 08

## ADVANCED OPERATIONS

### Dialing from Memory

1. Press the desired **LINE** key to get a dial tone.
2. Press **MEM/PROG**. The LCD displays **SPEED DIAL LOCATION** \_\_.
3. Enter the 2-digit Memory location (01-20).

### Alternate Memory Dialing Method

1. With the Handset OFF, Press **MEM/PROG**. The LCD displays **SPEED DIAL LOCATION** \_\_.
2. Enter the 2-digit Memory location (01-20).
3. Press the desired **LINE** key. After a 2 second delay to allow for a dial tone, the phone number displayed on the LCD will be generated.

#### NOTE:

Any digits displayed in the LCD prior to entering Memory Dialing mode will be appended to the front of the contents of your selected memory location. For example, if **1800** was entered (with the Handset OFF), and the phone number in the memory location you selected was **5551212**, the number that would be dialed upon pressing a **LINE** key becomes **1-800-555-1212**.

### CHANGING STORED NUMBERS

To change or replace a number stored in a memory location, simply follow the steps outlined in *Programming Phone Numbers into Memory*. The new phone number will be stored in any location you designate. Any phone number previously stored in that location will be deleted.

### DELETING STORED NUMBERS

You can delete individual phone numbers stored in memory, or all stored numbers at one time.

#### To Delete a single phone number stored in Memory:

With the Handset OFF, press the **MEM/PROG** key, and then access the desired memory location by entering the 2-digit location number (01-20), or by scrolling through the directory using the \* ( ◀ ) and # ( ▶ ) keys.

Once you have found the desired memory location, press and hold the **INT.COM** key until the LCD displays:



LOCATION XX  
DELETED

#### To delete all phone numbers stored in Memory:

With the Handset OFF, press the **MEM/PROG** key, and then access any memory location by entering a 2-digit location number (01-20), or by scrolling through the directory using the \* and # keys.

Once a Memory location is displayed in the LCD, press and hold the **CONF/CLEAR** key until the LCD changes to **DELETE ALL? DEL TO ALLOW**.

To confirm, press **INT.COM/DEL**. The LCD will display **DELETING ALL LOCATIONS**. To cancel mass deletion of stored phone numbers, press **OFF** instead.

## CID-CALLER ID

Your **VT 2960** cordless telephone is capable of displaying the name and phone number of the calling party, before you answer the call. In addition, it will display Caller ID information when you are on the phone and receive a **Call Waiting** signal. **Subscription to CALLER ID and CALL WAITING ID** (otherwise known as Type II Caller ID) through your local telephone service provider is **required** to fully utilize this feature. The names of these services may vary from one provider to another.

If you subscribe to **alphanumeric** (name & number) Caller ID service, the calling party's **name** and **number** (when available) will be displayed as the call comes in.

If you subscribe to **numeric** (number only) Caller ID service, the calling party's phone number (when available) as the call comes in.

### **A WORD ABOUT CALLER ID - CID**

Due to regional incompatibilities, Caller ID information will **not** be available for every call you receive. In addition, the calling parties may intentionally block their name and phone number from being sent.

### **Examples of Caller ID Displays**

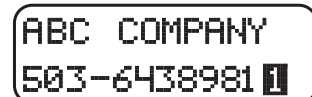

ABC COMPANY  
503-6438981

ABC Company is calling on LINE 1.



12 NEW CALLS

12 CID records have been received since you last reviewed them.



CALL # 01  
ABC COMPANY

Press the **CID** key to view CID records. The LCD will display the most recent record (#01). Press the \* (◀) and # (▶) keys to scroll through the records. The **VT 2960** stores the last 50 calls received. An arrow at the end of the name indicates that there are additional characters to be viewed.



ABC COMPANY  
LTD

While reviewing a CID record, press and hold the **9** (▶) key. Additional letters, if any, will be displayed (to a maximum of 15 characters, including spaces).

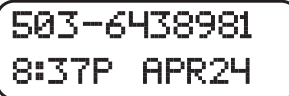

503-6438981  
8:37P APR24

While reviewing a CID record, press and hold the **7** (⊙) key. The caller's phone number, along with the time and date of the call is displayed.



UNAVAILABLE  
UNAVAILABLE

Neither name nor number is available (call came in on LINE 1).



PRIVATE  
PRIVATE

Caller has blocked CID data from being transmitted (call came in on LINE 2).

## CID-CALLER ID

TRANSMISSION  
ERROR LINE X

Caller ID data transmission is incomplete. If this display appears often, contact your local service provider.

### DELETING CID RECORDS

Your **VT 2960** stores the most recent 50 CID records in memory. When CID memory is completely filled, the **oldest** record is automatically deleted as a new call is stored. Therefore, you do **not** have to delete CID records manually. However, if you want to delete CID records, follow the steps listed below:

#### Deleting a single CID record

1. With the Handset OFF, press the **CID** key. The most recent call will be displayed on the LCD (Call #01).
2. Press the \* (◀) or # (▶) keys to scroll to the desired record.
3. Press and hold the **INT.COM/DELETE** key until the LCD displays **DELETING SINGLE CALL**.
4. If you have other records to delete, scroll to the desired record and repeat the process.
5. Press **OFF** when done.

#### Deleting ALL CID records

1. With the Handset OFF, press the **CID** key. The most recent call will be displayed on the LCD (Call #01).
2. Press and hold the **CONF/CLEAR** key until the LCD displays **DELETE ALL? DEL TO ALLOW**.

3. Press **INT.COM/DELETE** to confirm deletion of all CID records. The LCD will display **DELETING ALL CALLS**. Pressing any key other than **INT.COM/DELETE** cancel this operation.

### DIALING FROM CID MEMORY

**NOTE:** Only the last 7 digits of the phone number will be dialed from CID memory. You can manually append additional digits ("1" plus area code, for example) to the number prior to dialing.

1. With the Handset OFF, press **CALLER ID**.
2. Use the \* (◀) or # (▶) keys to scroll to the desired CID record.
3. Press the desired **LINE** key. The number associated with the CID record will be dialed (last 7 digits only).

#### Adding digits for CID dialing

For example, if the CID record is:

503-6438981  
8:37A JUN8

only **643-8981** will be dialed when the **LINE** key is pressed. To dial **1(503)643-8981**, do the following:

1. With the Handset OFF, enter **1503**.
2. Press **CID**.
3. Use the \* (◀) or # (▶) key to scroll to the CID record.
4. Press the desired **LINE** key. The number dialed will include the long distance "1" plus the area code.

## CID-CALLER ID

### **STORING CID RECORDS IN MEMORY DIALING LOCATIONS**

You can store a phone number from a CID record in a *Memory Dialing* location.

1. With the Handset OFF, press the **CID** key.
2. Use the \* (◀) or # (▶) keys to scroll to the CID record you wish to store in memory.
3. Press **CID** again. The LCD displays the phone number.
4. Press and hold the **MEM/PROG** key. The LCD will display **PROGRAM LOCATION** \_\_.
5. Enter a 2-digit memory location (01-20). The Handset will emit a warbled, happy tone to confirm successful programming.

Similar to Dialing from CID Memory, if you need to append digits to the phone number prior to storing in a Memory Dialing location (for example, "1" plus Area Code), simply enter the digits (with the Handset OFF), and follow steps 1 - 5 above.

## THE VT2960 ANSWERING SYSTEM

### PLEASE READ AND FOLLOW THE INSTRUCTIONS STEP BY STEP

#### The VT2960 Answering System will:

- Record messages on either **Line 1**, **Line 2**, or both lines.
- Play your outbound announcement without recording messages on either **Line 1**, **Line 2**, or **both lines** (Announce-Only mode).
- Allow you to record two separate outbound announcements for each line; one for **normal** (accept messages) mode, and one for **Announce-Only** mode.
- Allow you to play messages recorded from **Line 1**, **Line 2**, or both lines.

### SETTING UP YOUR VT2960 ANSWERING SYSTEM

The VT2960 Answering System allows you to customize the following features for each line:

- Your Outgoing Message
- Security Code for remote access
- Announce -Only (answers calls without accepting messages)
- Number of rings at which the answering system will "pick-up"

### RECORDING YOUR OUTGOING MESSAGES

1. Press **MENU**. Voice prompt says, "Please select line."
2. Press **SELECT**. Voice prompt says, "Line 1" or "Line 2". Choose the line you want to program.
3. Press **TIME/SET** to confirm your line choice. Voice prompt says, "Line 1 (or 2) Selected," followed by a beep; then the voice prompt will say "Set Outgoing Message."
4. Press **RECORD/MEMO**. Voice prompt says "Now Recording." Record your outgoing message, speaking towards the front edge of

the Base Unit. The Base display becomes a timer as you record your message.

5. Press **STOP/PLAY** when you complete your outgoing message. It will automatically be played back to you. You can re-record your outgoing message at any time, by repeating the above sequence.

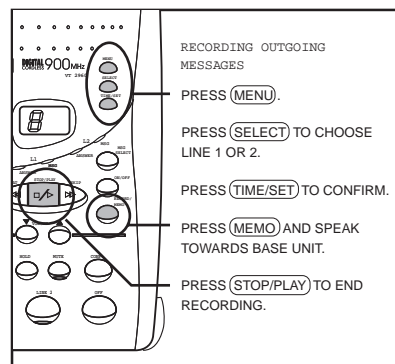

### PLAYBACK OF OUTGOING MESSAGES

To listen to your outgoing message, do the following:

1. Press **MENU**. Voice prompt says, "Please select line."
2. Press **SELECT** to choose the desired line.
3. Press **TIME/SET** to hear confirmation of your line choice, followed by "Set outgoing message."
4. Press **STOP/PLAY** to hear the outgoing message.

### SETTING SECURITY CODES

In order to access your VT2960 remotely, from another telephone line, a two-digit security code is required (see **REMOTE OPERATIONS**). This code is preset at **19** for **Line 1** and **29** for **Line 2**. You can assign any two-digit code, from 00 to 99, to each line. It is recommended that you assign a

## THE VT2960 ANSWERING SYSTEM

different security code for each line. To set the security code:

1. Press **MENU**. Voice prompt says, "Please select line."
2. Press **SELECT** until the voice prompt announces the desired line.
3. Press **TIME/SET**. The voice prompt will confirm your line choice, followed by "Set outgoing message."
4. Press **MENU**. Voice prompt says, "Set Security Code."
5. Press **SELECT**. Voice prompt says, "XX" (current security code).
6. Press **SELECT** to change your security code. Hold the **SELECT** button down to increase the security code by increments of 10.
7. When you have reached the desired security code, press **TIME/SET**. Voice prompt says, "Security Code is XX".

Press **MENU** to advance to the next programming function, or press **STOP/PLAY** to exit programming mode.

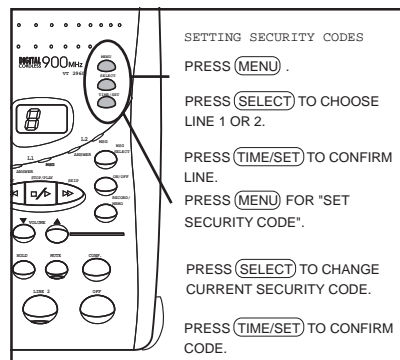

### SETTING ANNOUNCE-ONLY MODE

The **VT2960** is preset to record your callers' messages. You can also program one or both lines to simply play an outgoing message without recording incoming messages; for example:

"We are unavailable to take your call. Please call back later."

1. Press **MENU**. Voice prompt says, "Please select line."
2. Press **SELECT**. Voice prompt says, "Line 1" or "Line 2". Choose the line you want to program.
3. Press **TIME/SET**. Voice prompt says, "Line 1 (or 2) Selected," Followed by a beep; then the voice prompt will say "Set Outgoing Message."
4. Press **MENU** twice, until voice prompt says, "Set Announce-Only."
5. Press **SELECT**. Voice prompt says, "ON" or "OFF". If you want the answering system to play your outgoing messages without recording callers' messages, select **ON**. Otherwise, announce-only mode should be set to **OFF** (callers' messages will be recorded).
6. Press **TIME/SET** to confirm your selection. Voice prompt says, "Announce-Only is ON" (or "OFF"). Press **MENU** to advance to the next programming function, or press **STOP/PLAY** to exit programming mode.

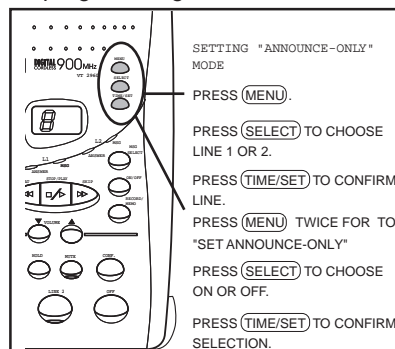

**IMPORTANT!!** To record your callers' messages, **Announce-Only** must be set to **OFF**. If you want your callers to hear your outgoing messages only, without allowing them to leave messages, **Announce-Only** must be set to **ON**.

## THE VT2960 ANSWERING SYSTEM

### SETTING THE NUMBER OF RINGS

For each line, the answering system can answer calls after **2, 4 or 6 rings**; or **Toll Saver**.

Toll Saver is a feature which, when selected, will command the answering system to answer an inbound call after **2 rings only** if there are new, unplayed messages in memory. Otherwise, the answering system will answer after 4 rings. The purpose of this feature is to assist you in avoiding long distance charges when calling your **VT2960** from a remote location to retrieve messages. If the **VT2960** does not answer after 2 rings, you can hang up. There aren't any new messages. To set the number of rings:

1. Press **MENU**. Voice prompt says, "**Please select line.**"
2. Press **SELECT** to choose the desired line.
3. Press **TIME/SET** to hear confirmation of your line choice, followed by "**Set outgoing message.**"
4. Press **MENU** three times, until voice prompt says, "**Set number of rings.**"
5. Press **SELECT** to choose between **2, 4, 6 rings**, or **Toll Saver**.
6. Press **TIME/SET** to confirm your choice. Voice prompt will say, "**Number of Rings selected is \_\_\_\_\_.**"

Press **MENU** to advance to the next programming function, or press **STOP/PLAY** to exit programming mode.

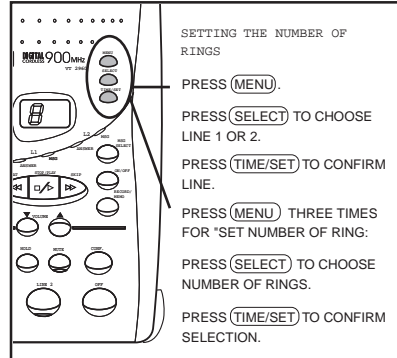

The following programming affects both lines, simultaneously:

- Call Screening
- Audible Message Alert
- Day and Time

### CALL SCREENING

This feature allows you to hear incoming messages at the Base Unit, while they are being recorded. To program Call Screening:

1. Press **MENU** twice. Voice prompt says, "**Set Call Screening.**"
2. Press **SELECT** to choose "**ON**" or "**OFF**"
3. Press **TIME/SET** to confirm your selection ("**Call Screening is \_\_\_\_\_**")

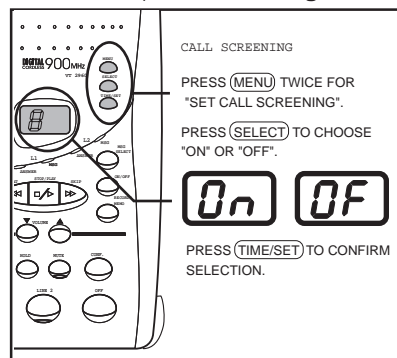

4. Press **MENU** to advance to the next programming function, or press **STOP/PLAY** to exit programming mode.

## THE VT2960 ANSWERING SYSTEM

### AUDIBLE MESSAGE ALERT

This feature provides a beep tone from the Base Unit at approximately 10 second intervals, alerting you to new, unplayed messages. To program Audible Message Alert:

1. Press **MENU** three times. Voice prompt says, "Set Audible Message Alert."
2. Press **SELECT** to choose "ON" or "OFF".
3. Press **TIME/SET** to confirm your selection. ("Audible Message Alert is \_\_\_\_")
4. Press **MENU** to advance to the next programming function, or press **STOP/PLAY** to exit programming mode .

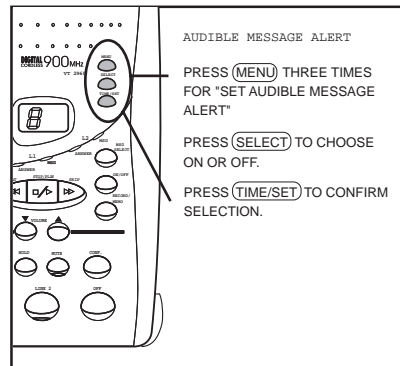

### SETTING THE DAY AND TIME

1. Press **MENU** four times until voice prompt says, "Set Day and Time."
2. Press **SELECT** to choose the correct day.
3. Press **TIME/SET**. Voice prompt will announce an hour setting.
4. Press **SELECT** until you reach the correct hour.
5. Press **TIME/SET**. Voice prompt will announce a minute setting.
6. Press **SELECT** until you reach the correct minute. Holding the

**SELECT** button down will increase the minute setting by increments of 10.

7. Press **TIME/SET**. Voice prompt will announce the current day and time.
8. Press **STOP/PLAY** to exit programming mode.

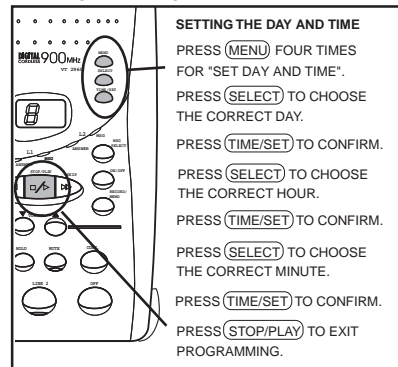

### BASIC ANSWERING SYSTEM OPERATION

#### TURNING THE ANSWERING SYSTEM ON AND OFF

As you press the **ON/OFF** button repeatedly, the voice prompt goes through the following sequence, and the corresponding **L1 ANSWER** and **L2 ANSWER** indicators will illuminate:

"Answering Machine **ON** for Both Lines"

"Answering Machine **ON** for Line 1, OFF for Line 2"

"Answering Machine OFF for Line 1, **ON** for Line 2"

"Answering Machine **OFF** for Both Lines"

**NOTE:** If **L1 Answer** and/or **L2 Answer** indicators are flashing, it is to remind you that the system is in the **Announce-Only** mode for that particular line(s).

## THE VT2960 ANSWERING SYSTEM

### SELECTING LINES FOR MESSAGE PLAYBACK

Pressing the **MSG SELECT** button allows you to hear recorded messages from **Line 1**, **Line 2**, or **Both Lines**. As you press **MSG SELECT**, the corresponding **L1 MSG** and **L2 MSG** indicators will illuminate.

### PLAY

Press **STOP/PLAY** to play messages. Press **STOP/PLAY** again to stop.

If there are new, unplayed messages, your **VT2960** will play only those new messages, and then stop. Press **STOP/PLAY** again to review previously heard messages.

### ERASE

Press **ERASE** during message playback to erase the message currently being played.

While the **VT2960** is in idle mode, press **ERASE** to delete all old, previously heard messages.

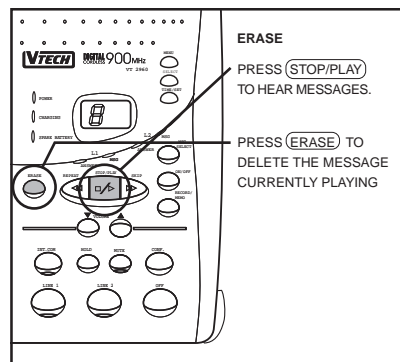

### SKIP >>

During message playback, press **SKIP** to advance to the next message.

### REPEAT <<

During message playback, press **REPEAT** to return to the beginning of the message currently being played. Press **REPEAT** twice during message playback to return to the previous message.

### VOLUME

The **VOLUME UP** and **VOLUME DOWN** buttons control the answering system playback volume.

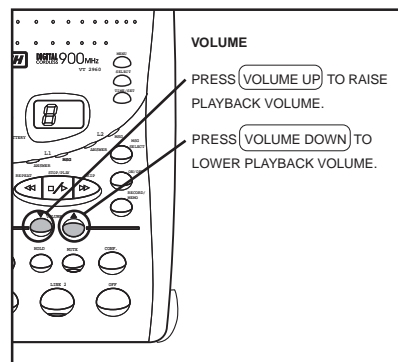

## THE VT2960 ANSWERING SYSTEM

### MEMO RECORDING

To record a memo, do the following:

1. Press **RECORD/MEMO**. Voice prompt says, "**Now Recording**," followed by a beep. Speak toward the front of the Base Unit.
2. Press **STOP/PLAY** when finished. Voice prompt says, "**End of Recording**," followed by a beep.

The message counter stores a memo as a new message.

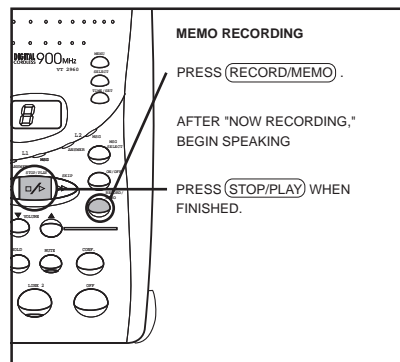

### REMOTE OPERATION OF YOUR VT2960 ANSWERING SYSTEM

From a remote location, you can access many of the answering system features, such as listening to messages and changing your outgoing message.

Touch Tone service is required to access your **VT2960** remotely.

To access your **VT2960** answering system from a remote location, dial one of the telephone numbers to which the system is connected. Once you hear the outgoing message begin:

Press #, then the appropriate 2-digit security code.

You will then hear a confirmation beep, followed by an announcement of how many messages are in memory for that line. Afterwards, automatic playback of messages will begin.

The following is a **menu of remote commands and functions**:

### BASIC FUNCTIONS

- Press **#2** to play all messages
- Press **#5** to STOP (playback or recording)
- Press **#4** to repeat the message
- Press **#6** to skip to the next message
- Press **#9** (during playback) to erase the message
- Press **#3** (then # and the appropriate security code) to access the other line
- Press **#1** for advanced functions

### ADVANCED FUNCTIONS

- Press **#7** to review your outgoing message
- Press **\*7** to record your outgoing message
- Press **\*8** to record a memo
- Press **#4** twice to repeat previous message
- Press **#0** to turn the system on or off
- Press **#1** for basic functions
- Press **\*0** to exit remote control mode

# HEADSET INSTALLATION AND OPERATING INSTRUCTIONS

Your **VT2960** cordless telephone is equipped with a 2.5mm Headset Jack for use with an optional accessory Headset or hands-free operation. If you choose to use the Headset option, you must do the following:

## INSTALLATION

Obtain an optional accessory Headset, which is compatible with the **VT2960**.

Once you have a compatible 2.5mm Headset, locate the Headset Jack on the Handset of your **VT2960**. Connect the plug on the Headset to the jack on the cordless Handset. The plug should fit securely. Do not force the connection. See illustration.

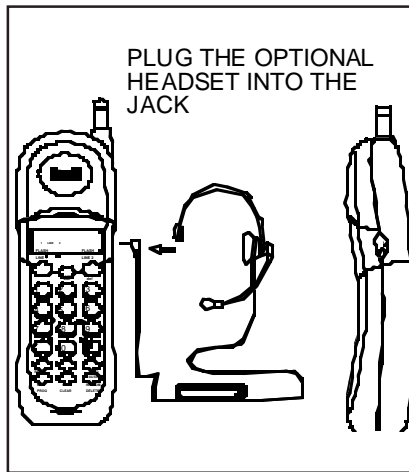

The headset has a monaural design which is reversible, so you can wear your Headset on either the left or right ear, leaving one ear free for room conversation.

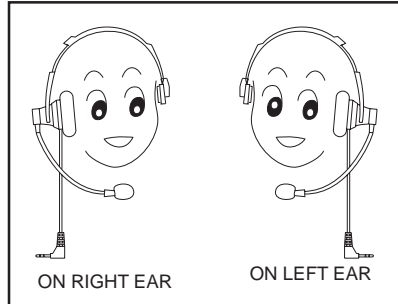

The headband can be adjusted to fit the contour of your head. Using both hands, slide the headband up or down so that it rests comfortably on your head with the speaker cushion centered against your ear.

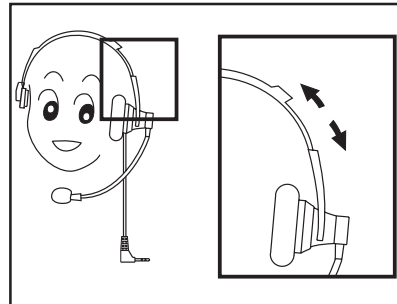

For maximum sound quality, the flexible microphone should be positioned at the corner of your mouth, about one inch from your face. For maximum sound quality, the flexible microphone should be positioned at the corner of your mouth, about one inch from your face.

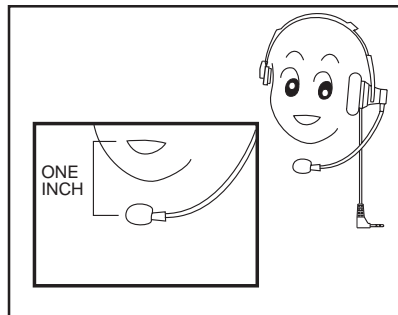

## MAINTENANCE

### MAINTENANCE TAKING CARE OF YOUR TELEPHONE.

Your **VTech VT 2960** cordless telephone contains sophisticated electronic parts so it must be treated with care.

#### Avoid rough treatment

Place the Handset down gently. Save the original packing materials to protect your telephone if you ever need to ship it.

#### Avoid water

Your telephone can be damaged if it gets wet. Do not use the Handset outdoors in the rain, or handle it with wet hands. Do not install your Base Unit near a sink, bathtub or shower.

Remember that electrical appliances can cause serious injury if used when you are wet or standing in water. If your Base Unit should fall into water, **DO NOT RETRIEVE IT UNTIL YOU UNPLUG THE POWER CORD AND TELEPHONE LINE CORDS FROM THE WALL.** Then pull the unit out by the unplugged cords.

#### Electrical storms

Electrical storms can sometimes cause power surges harmful to electronic equipment.

For your own safety, use caution when using electric appliances during storms.

#### Cleaning your telephone

Your telephone has a durable plastic casing that should retain its luster for many years. Clean it only with a soft cloth slightly dampened with water or a mild soap. Do not use excess water or cleaning solvents of any kind.

## IN CASE OF DIFFICULTY

If you have difficulty operating your phone, the suggestions below should solve the problem. If you still have difficulty after trying these suggestions, In the US call:

**VTech Communications at  
1-800-595-9511**

In Canada call **VTECH Electronics at  
1-500-267-7377**

### **THE PHONE DOESN'T WORK AT ALL.**

- Make sure the power cord is plugged in.
- Make sure the telephone line cord is plugged firmly into the Base Unit and the telephone wall jack.
- Make sure the battery pack is properly charged. If the **LOW BATTERY** is displayed on the Handset, the battery pack needs charging. If a **LINE LED** (on the Base Unit) and a **LINE** indicator (on the Handset) do not light when you press a **LINE** key, you should charge the battery pack.
- If you recently installed a new battery pack, make sure it is installed correctly.

### **NO DIAL TONE.**

- First check all the suggestions above.
- If you still don't hear a dial tone, disconnect the Base Unit from the telephone jack and connect a different phone. If there is no dial tone on that phone either, the problem is in your wiring or local service. Call your local telephone company.

### **YOU GET NOISE, STATIC, OR A WEAK SIGNAL EVEN WHEN YOU'RE NEAR THE BASE UNIT.**

- Place the Handset in the Base momentarily to reset the security code. Then press **LINE** to get a line.

Household appliances plugged into the same circuit as the Base Unit can sometimes cause interference. Try moving the appliance or the Base Unit to another outlet.

### **YOU GET NOISE, STATIC, OR A WEAK SIGNAL WHEN YOU'RE AWAY FROM THE BASE UNIT.**

- You may be out of range. Either move close to the base, or relocate the Base Unit.
- The layout of your home may be limiting the range. Try moving the Base Unit to the second or third floor, or to some other location.

### **THE HANDSET DOES NOT RING WHEN YOU RECEIVE A CALL.**

- Ensure that the ringer is turned on.
- Make sure the telephone line cord is plugged firmly into the Base Unit and the telephone jack. Make sure the power cord is plugged in.
- You may be too far from the Base Unit.
- You may have too many extension phones on your telephone line to allow all of them to ring. Try unplugging some of the other phones.

### **THE BASE DOES NOT RING**

- Make sure the **BASE RINGER** switch is not set to off.
- There may be too many extension phones on your line. Try unplugging one of the other phones.

## IN CASE OF DIFFICULTY

### **YOUR CALLER FADES IN AND OUT.**

You may be nearly out of range. Move closer, or relocate the base.

### **YOU HEAR OTHER CALLS WHILE USING YOUR PHONE.**

- Replace the Handset in the base cradle, wait a few moments and try again.
- Disconnect your Base Unit from the telephone jack, and plug in a regular telephone. If you still hear other calls, the problem is probably in your wiring or local service. Call your local telephone company.

### **YOU HEAR NOISE IN THE HANDSET, AND NONE OF THE KEYS OR BUTTONS WORK.**

- Make sure the power cord is plugged in.
- Your Base Unit and Handset may not be operating on the same channel or security code. Place the Handset in the cradle for a few moments to reload the security code and reset the channel.

### **COMMON CURE FOR ELECTRONIC EQUIPMENT**

Electronics, like people, can sometimes get confused. If the unit does not seem to be responding normally, then try putting the Handset in the cradle to re-initialize the unit. If it still does not seem to respond, perform the following steps (in the order listed):

1. Disconnect the power to the Base Unit.
2. Remove the Handset battery Pack
3. Wait a few minutes.
4. Connect power to the Base Unit.
5. Install the Handset battery pack.
6. Watch for the Handset to display "FOUND CHANNEL X".

## WARRANTY STATEMENT

### WHAT DOES OUR WARRANTY COVER?

- Any defect in material or workmanship.

### FOR HOW LONG AFTER THE ORIGINAL PURCHASE?

- To the original purchaser only - ONE YEAR.

### WHAT WILL VTECH DO?

- At our option, repair or replace your unit.

### HOW DO I SEND MY UNIT, IN OR OUT OF WARRANTY?

- In the U.S. Call VTECH Communications customer service for Return Authorization at: **1-800-595-9511**  
In Canada call VTECH Electronics at:  
**1-800-267-7377**
- Properly pack your unit. Include any cables & accessories which were originally provided with the product. We recommend using the original carton and packing materials.
- Include in the package a copy of the sales receipt or other evidence of date of original purchase (if the unit was purchased within the last twelve months).
- Print your name and address, along with a description of the defect, and include this in the package.
- Include payment for any service or repair not covered by warranty, as determined by VTECH Communications.
- Ship the unit via UPS Insured, or equivalent to:  
In the U.S.

**VTECH COMMUNICATIONS**  
8770 SW NIMBUS AVENUE  
BEAVERTON, OREGON 97008

In Canada

**VTECH ELECTRONICS**  
SUITE 200-7671 ALDERBRIDGE WAY  
RICHMOND, B.C. V6X 1Z9

***VTECH Communications assumes no responsibility for units sent without prior Return Authorization.***

## WARRANTY STATEMENT

### WHAT DOES OUR WARRANTY NOT COVER?

- Batteries
- Damage from misuse, neglect, or acts of nature (lightning, floods, power surges, etc.)
- Products which may have been modified or incorporated into other products
- Products purchased and/or operated outside the USA, its territories, or Canada.
- Products serviced by the owner or a service facility not expressly authorized by VTECH Communications
- Products purchased more than 12 months from current date
- Units purchased in "AS IS" condition, or units purchased as "Distressed Merchandise".

### HOW DOES STATE LAW OR PROVINCIAL LAW RELATE TO THIS WARRANTY?

- This warranty gives you specific rights. You may also have other rights which vary from state to state or province to province.

## FCC AND IC REGULATIONS

This equipment complies with Parts 15 and 68 of the Federal Communications Commission (FCC) rules for the United States. It also complies with Industry Canada (IC) rules RSS210 and CS-03 for Canada.

A label is located on the underside of the Base Unit containing either the FCC registration number and Ringer Equivalence Number (REN). You must, upon request, provide this information to your local telephone company.

This equipment is compatible with inductively coupled hearing aids.

Should you experience trouble with this telephone equipment, please contact:

**In the United States:  
VTECH COMMUNICATIONS  
1-800-595-9511  
IN CANADA:  
VTECH ELECTRONICS  
1-800-267-7377**

for repair/warranty information. The telephone company may ask you to disconnect this equipment from the line network until the problem has been corrected.

Your **VT 2960** is designed to operate at the maximum power allowed by the FCC and IC. This means your Handset and Base Unit can communicate only over a certain distance - which will depend on the location of the Base Unit and Handset, weather, and the construction and layout of your home or office.

### FCC Part 15

**Warning:** Changes or modifications to this unit not expressly approved by the party responsible for compliance's could void the user's authority to operate the equipment.

The equipment has been tested and found to comply with part 15 of the FCC rules. These limits are designed to provide reasonable protection against harmful interference in a residential installation. This equipment generates, uses and can radiate radio frequency energy and, if not installed and used in accordance with the instructions, may cause harmful interference to radio communications. However, there is no guarantee that interference will not occur in a particular installation. If this equipment does cause harmful interference to radio or television reception, which can be determined by turning the equipment off and on, the user is encouraged to try and correct the interference by one or more of the following measures:

- Re-orientate or relocate the receiving antenna.
- Increase the separation between the equipment and receiver.
- Connect the equipment into an outlet or on a circuit different from that to which the receiver is connected.
- Consult the dealer or an experienced radio/TV technician for help.

## FCC AND IC REGULATIONS

### **FCC Part 68**

The FCC requires that you connect your cordless telephone to the nationwide telephone network through a modular telephone jack (USOC RJ11C/RJ11W or RJ14C/RJ14W).

Your telephone company may discontinue your service if your equipment causes harm to the telephone network. They will notify you in advance of disconnection, if possible. During notification, you will be informed of your right to file a complaint with the FCC.

Occasionally, your telephone company may make changes in its facilities, equipment, operation, or procedures that could affect the operation of your equipment. If so, you will be given advance notice of the change to give you an opportunity to maintain uninterrupted service.

The Base Unit contains no user serviceable parts. The Handset contains a user replaceable battery pack.

If it is determined that your telephone equipment is malfunctioning, the FCC requires that it not be used and that it be unplugged from the modular jack until the problem has been corrected. Repairs to this telephone equipment can only be made by the manufacturer or its authorized agents or by others who may be authorized by the FCC. For repair procedures, follow the instructions outlined under the VTECH Limited Warranty.

This equipment may not be used on coin service provided by the phone company or Party Lines.

The REN is useful in determining the number of devices you may connect to your telephone line and still enable the devices to ring when you receive a call. The general rule is that the REN value should not exceed 5.0 total; however, contact your local telephone company for the specific number in your area.

## FCC AND IC REGULATIONS

### IC (Industry Canada)

This telephone is registered for use in Canada.

**Notice:** The REN/IES assigned to this telephone determines the number of devices you may connect to the telephone loop which is used by the device to prevent overloading. The termination on a loop may consist of any combination of devices subjected only to the requirement that the sum of the REN/IES does not exceed five (5.0).

**Notice:** The Industry Canada label identifies certified equipment. This certification means that the equipment meets certain telecommunications network protective, operational and safety requirements. The Department does not guarantee the equipment will operate to user's satisfaction.

Before installing this equipment, user's should ensure that it is permissible to be connected to the facilities of the local telecommunications company. The equipment must also be installed using an acceptable method of connection. The customer should be aware that compliance with the above conditions may not prevent degradation of services in some situations.

Repairs to certified equipment should be made by an authorized Canadian maintenance facility designated by the supplier. Any repairs or alterations made by the user to this equipment, or equipment malfunctions, may give the telecommunications company cause to request the user to disconnect the equipment.

Users should ensure for their own protection that the electrical ground connections of the power utility, telephone lines and internal metallic water pipe system, if present, are connected together. The precaution may be particularly important in rural areas.

**Caution:** Users should not attempt to make such connections themselves, but should contact the appropriate electrician, as appropriate.

## SPECIFICATIONS

### FREQUENCY CONTROL

Crystal Controlled Dual PLL Synthesizer

### TRANSMIT FREQUENCY

Handset: 925.05 MHz to 927.75 MHz  
(All ten channels within this range)

Base : 902.3 MHz to 905.0 MHz  
(All ten channels within this range)

### RECEIVE FREQUENCY

Handset: 902.3 MHz to 905.0 MHz  
(All ten channels within this range)

Base : 925.05 MHz to 927.75 MHz  
(All ten channels within this range)

### NOMINAL EFFECTIVE RANGE

Maximum power allowed by FCC and IC.  
Actual operating range may vary according to environmental conditions at the time of use.

### SIZE

Handset: 202x64x46 mm (LxWxT)  
Maximum (Antenna excluded)

Base : 225x205x64.5mm (LxWxT)  
Maximum (Antenna excluded)

### WEIGHT

Handset : 292 g (Battery included)  
Base : 800 g

### POWER REQUIREMENTS

Handset : Self-contained nickel-cadmium rechargeable battery supply, 3.6V nominal, 600mAh capacity.

Base : 11V DC 600mA

### MEMORY

Speed Dial: 20 Memory locations, 20 digits per location.

CID : Alpha Numeric Display 50 Memory locations.

ITAD : 15 minutes of Digital record time from all sources.

**VTECH reserves the right to make design and specification changes for product improvement without prior notice.**

# TABLE OF CONTENTS

<b>INTRODUCTION</b> .....	<b>1</b>
Special Features .....	2
Parts Checklist .....	3
<b>IMPORTANT SAFETY INSTRUCTIONS</b> .....	<b>4</b>
<b>RECHARGEABLE BATTERY PACKS</b> .....	<b>6</b>
Charging the Handset Battery Pack .....	6
To Charge the Battery Pack .....	6
Spare Battery Charger .....	6
A Word about Rechargeable Batteries .....	6
Replacing the Handset Battery Pack .....	7
<b>WALL MOUNTING</b> .....	<b>8</b>
<b>HANDSET FEATURES</b> .....	<b>9</b>
LINE1/FLASH KEY .....	10
LINE2/FLASH KEY .....	10
OFF KEY .....	10
* TONE KEY .....	10
MEM/PROG (MEMORY/PROGRAM) KEY .....	10
CALLER ID KEY .....	10
REDIAL KEY .....	11
HOLD/PAUSE KEY .....	11
CONF/CLEAR (CONFERENCE/CLEAR) KEY .....	11
INT.COM/DELETE (INTERCOM/DELETE) KEY .....	11
VOLUME CONTROL KEYS .....	12
<b>EXAMPLES OF DISPLAY MESSAGES</b> .....	<b>13</b>
<b>BASE UNIT FEATURES</b> .....	<b>16</b>
BASE INDICATOR LIGHTS .....	17
POWER Indicator .....	17
CHARGING Indicator .....	17
SPARE BATT Indicator .....	17
INT.COM (INTERCOM) Indicator .....	17
MUTE Indicator .....	17
LINE1 (EXTENSION IN USE) Indicator .....	17
LINE2 (EXTENSION IN USE) Indicator .....	17
LINE 1 KEY .....	17
LINE 2 KEY .....	17
OFF KEY .....	17
CONF (CONFERENCE) KEY .....	18
HOLD KEY .....	18
MUTE KEY .....	18
INT.COM (INTERCOM) KEY .....	18
VOLUME UP & DOWN KEYS .....	18
RINGER ON/OFF SWITCHES .....	18
TONE/PULSE SWITCH .....	18
<b>GETTING STARTED</b> .....	<b>19</b>
Setting up your <b>VT 2960</b> .....	19
<b>BASIC OPERATIONS</b> .....	<b>20</b>
MAKING CALLS .....	20
REDIAL .....	20
ANSWERING CALLS FROM THE HANDSET .....	21
ANSWERING CALLS FROM THE BASE UNIT (SPEAKERPHONE) .....	21
CALL WAITING .....	22

## TABLE OF CONTENTS

SWITCHING FROM THE HANDSET TO BASE OR BASE TO HANDSET .....	22
Switching from Handset to Base Unit Speakerphone .....	22
Switching from Speakerphone to Handset .....	22
INTERCOM/PAGE .....	22
Base Unit Paging Handset .....	23
Handset Paging Base Unit .....	23
<b>ADVANCED OPERATIONS .....</b>	<b>24</b>
CONFERENCE CALLS .....	24
PROGRAMMING THE RINGER .....	24
MEMORY DIALING .....	25
Programming Phone Numbers into Memory .....	25
Storing a Phone Number from REDIAL .....	25
Storing a Pause in a Phone Number .....	25
Dialing from Memory .....	26
Alternate Memory Dialing Method .....	26
CHANGING STORED NUMBERS .....	26
DELETING STORED NUMBERS .....	26
<b>CALLER ID (CID) .....</b>	<b>27</b>
A WORD ABOUT CALLER ID (CID) .....	27
DELETING CID RECORDS .....	28
DIALING FROM CID MEMORY .....	28
STORING CALLER ID (CID) RECORDS IN MEMORY DIALING LOCATIONS .....	29
<b>THE VT2960 ANSWERING SYSTEM.....</b>	<b>30</b>
SETTING UP YOUR VT2960 ANSWERING SYSTEM.....	30
RECORDING OUTGOING MESSAGES.....	30
PLAYBACK OF OUTGOING MESSAGES.....	30
SETTING SECURITY CODES.....	30
SETTING "ANNOUNCE-ONLY" MODE.....	31
SETTING THE NUMBER OF RINGS.....	32
CALL SCREENING.....	32
AUDIBLE MESSAGE ALERT.....	33
SETTING THE DAY AND TIME.....	33
TURNING THE ANSWERING SYSTEM ON AND OFF.....	33
SELECTING LINE(S) FOR MESSAGE PLAYBACK.....	34
BASIC ANSWERING SYSTEM OPERATION.....	34
PLAY.....	34
ERASE.....	34
SKIP.....	34
REPEAT.....	34
VOLUME.....	34
MEMO RECORDING.....	35
REMOTE OPERATION OF YOUR VT 2960 ANSWERING SYSTEM.....	35
<b>HEADSET INSTALLATION AND OPERATING INSTRUCTIONS.....</b>	<b>36</b>
<b>MAINTENANCE.....</b>	<b>37</b>
<b>IN CASE OF DIFFICULTY .....</b>	<b>38</b>
<b>WARRANTY STATEMENT .....</b>	<b>40</b>
<b>FCC AND IC REGULATIONS .....</b>	<b>42</b>
<b>SPECIFICATIONS .....</b>	<b>45</b>



VTECH COMMUNICATIONS LTD.



Is a trademark of VTECH COMMUNICATIONS LTD., a member  
of THE VTECH GROUP OF COMPANIES.

Distributed in the U.S.A. by VTECH Communications, 8770 SW Nimbus Avenue /  
Beaverton, Oregon, 97008.

Distributed in Canada by VTECH Electronics Canada Ltd., Suite 200 - 7671 Alderbridge  
Way Richmond, B.C. V6X 1Z9.

Copyright 1998 for VTECH COMMUNICATIONS LTD..  
Printed in China

91-4054-13-00  
ISSUE 0



VTech

VTech

DIGITAL CORDLESS 900MHz  
VT 2960

FLASH LINE 1 OFF FLASH LINE 2

1 2 abc 3 def  
4 ghi 5 jkl 6 mno  
7 pqrs 8 tuv 9 wxyz  
\* tone 0 oper #  
REDIAL CID HOLD  
MEM CONF PAGE IN/COM  
PROG CLEAR DELETE

POWER

CHARGING

SPARE BATTERY

ANSWER

L 1

ERASE

REPEAT

STOP/PLAY

SKIP

VOLUME

INT.COM

HOLD

MUTE

CONF.

LINE 1

LINE 2

OFF

MIC

MENU

SELECT

TIME/SET

MSG

L 2

MSG SELECT

ON/OFF

RECORD/MEMO

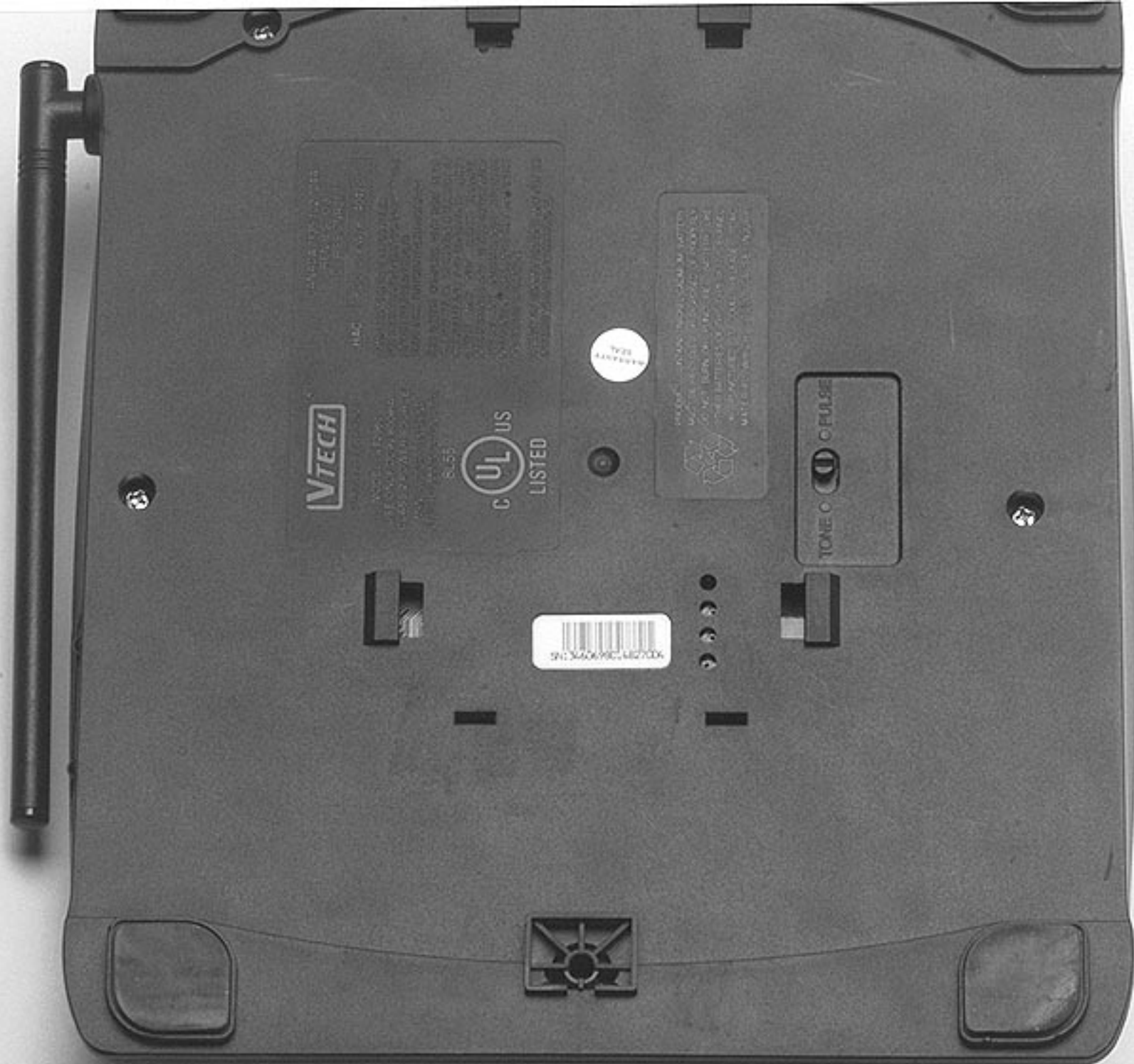

VTECH

UL LISTED

SN: 3A0690C14627006

TONE PULSE



**VTECH**

DIGITAL  
CORDLESS 900MHz  
VT 2960

MENU

SELECT

TIME/SET

POWER

CHARGING

SPARE  
BATTERY

MSG

L 2

MSG  
SELECT

ON/OFF

RECORD/MEMO

ANSWER

MSG

ANSWER

L 1

ERASE

REPEAT

STOP/PLAY

SKIP

VOLUME

INT.COM

HOLD

MUTE

CONF.

LINE 1

MIC

LINE 2

OFF



