



Important Safety Instructions

When using your telephone equipment, basic safety precautions should always be followed to reduce the risk of fire, electric shock and injury, including the following:

1. Read and understand all instructions.
2. Follow all warnings and instructions marked on the product.
3. Unplug this product from the wall outlet before cleaning. Do not use liquid cleaners or aerosol cleaners. Use a damp cloth for cleaning.
4. Do not use this product near water (for example, near a bath tub, kitchen sink, or swimming pool).
5. Do not place this product on an unstable cart, stand, or table. The product may fall, causing serious damage to the product.
6. Slots and openings in the cabinet and the back or bottom are provided for ventilation. To protect it from overheating, these openings must not be blocked by placing the product on the bed, sofa, rug, or other similar surface. This product should never be placed near or over a radiator or heat register. This product should not be placed in a built-in installation where proper ventilation is not provided.
7. This product should be operated only from the type of power source indicated on the marking label. If you are not sure of the type of power supply to your home, consult your dealer or local power company.
8. Do not allow anything to rest on the power cord. Do not locate this product where the cord will be abused by persons walking on it.
9. Never push objects of any kind into this product through cabinet slots as they may touch dangerous voltage points or short out parts that could result in a risk of fire or electric shock. Never spill liquid of any kind on the product.
10. To reduce the risk of electric shock, do not disassemble this product, but take it to an authorized service facility. Opening or removing cabinet parts other than specified access doors may expose you to dangerous voltages or other risks. Incorrect reassembling can cause electric shock when the appliance is subsequently used.
11. Do not overload wall outlets and extension cords as this can result in the risk of fire or electric shock.

Important Safety Instructions

12. Unplug this product from the wall outlet and refer servicing to an authorized service facility under the following conditions:
 - A. When the power supply cord or plug is damaged or frayed.
 - B. If liquid has been spilled into the product.
 - C. If the product has been exposed to rain or water.
 - D. If the product does not operate normally by following the operating instructions. Adjust only those controls that are covered by the operating instructions, because improper adjustment of other controls may result in damage and will often require extensive work by an authorized technician to restore the product to normal operation.
 - E. If the product has been dropped and the cabinet has been damaged.
 - F. If the product exhibits a distinct change in performance.
13. Avoid using a telephone (other than a cordless type) during an electrical storm. There may be a remote risk of electric shock from lighting.
14. Do not use the telephone to report a gas leak in the vicinity of the leak.



If you have questions about this product, or if you're having difficulty with setup or operation, do not return your phone to the store. Call our Customer Support Center at:

1-800-595-9511

In Canada, call

1-800-267-7377

SAVE THESE INSTRUCTIONS



Before You Begin

Enhanced 2.4GHz Technology - *Dual Band* transmission combines the best of 2.4GHz and 900MHz technologies, providing enhanced performance over standard cordless telephones.

About Caller Identification (Caller ID)

This product has a Caller ID with Call Waiting feature that works with service from your local phone service provider.

Caller ID with Call Waiting lets you see who's calling before you answer the phone, even when you're on another call.

You may need to change your phone service to use this feature. Contact your phone service provider if:

- You have both Caller ID and Call Waiting, but as separate services (you may need combined service)
- You have only Caller ID service, or only Call Waiting service.
- You don't subscribe to any Caller ID or Call Waiting services.

You can use this product with regular Caller ID service, and you can use this product's other features without subscribing to either Caller ID or combined Caller ID with Call Waiting service.

There are fees for Caller ID services, and they may not be available in all areas. This product can provide information only if both you and the caller are in areas offering Caller ID service, and if both telephone companies use compatible equipment.



Before You Begin

Parts Check List:

1. Base Unit
2. Handset
3. AC Power Adaptor
4. Telephone Line Cord
5. Battery Pack
6. Belt Clip
7. User's Manual

To purchase replacement battery packs, call VTech Communications, Inc. at 1-800-595-9511. In Canada, call VTech Telecommunications Canada Ltd. at 1-800-267-7377.



Handset

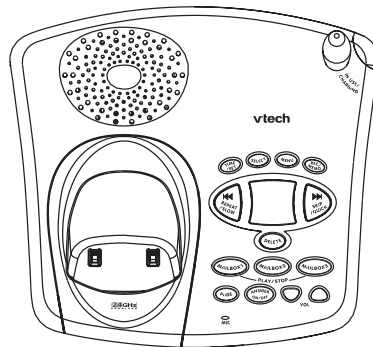

Base Unit



Telephone Line Cord

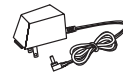

AC Power Adaptor



Battery Pack



User's Manual



Belt Clip



Installation

Before You Install

- 1 **Choose a location for the Base near an electrical outlet and a telephone jack.**

This phone requires a modular telephone jack and a standard electrical outlet (110v AC) not controlled by a wall switch.

- 2 **Install the Handset battery.**

Use only VTech battery.

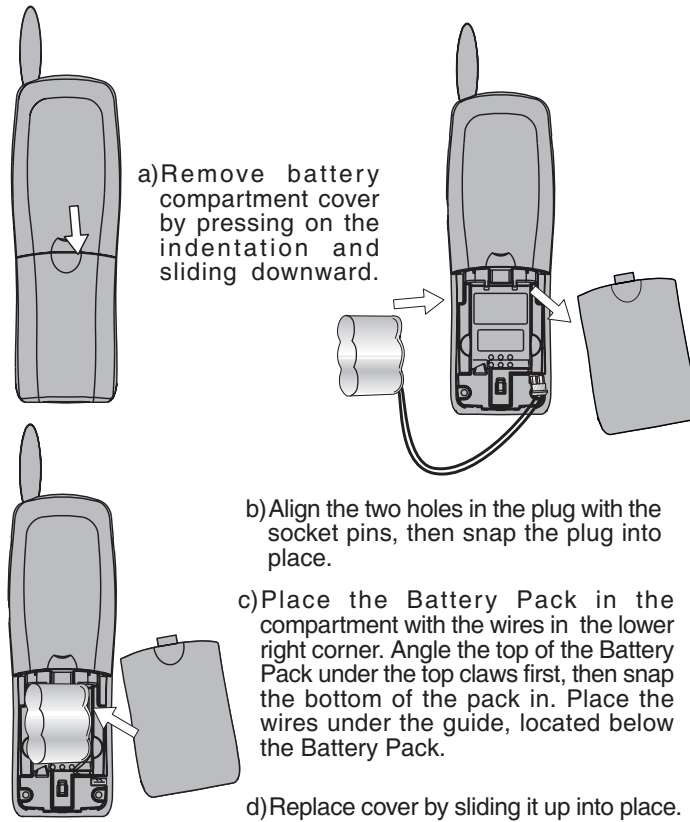

Installation

3 Attach Belt Clip to the cordless Handset (optional).

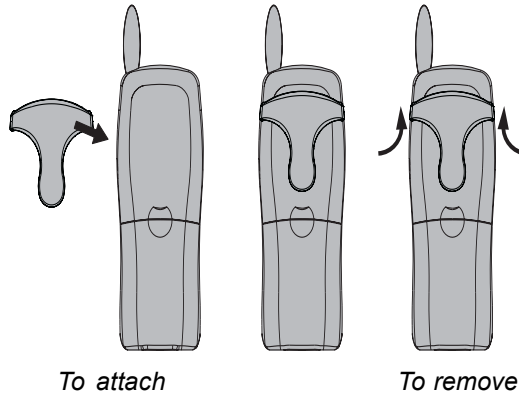

NOTE: Install the Base Unit away from electronic equipment such as personal computers, television sets or microwave ovens. Avoid excessive heat, cold, dust or moisture.

Table/Desk Installation

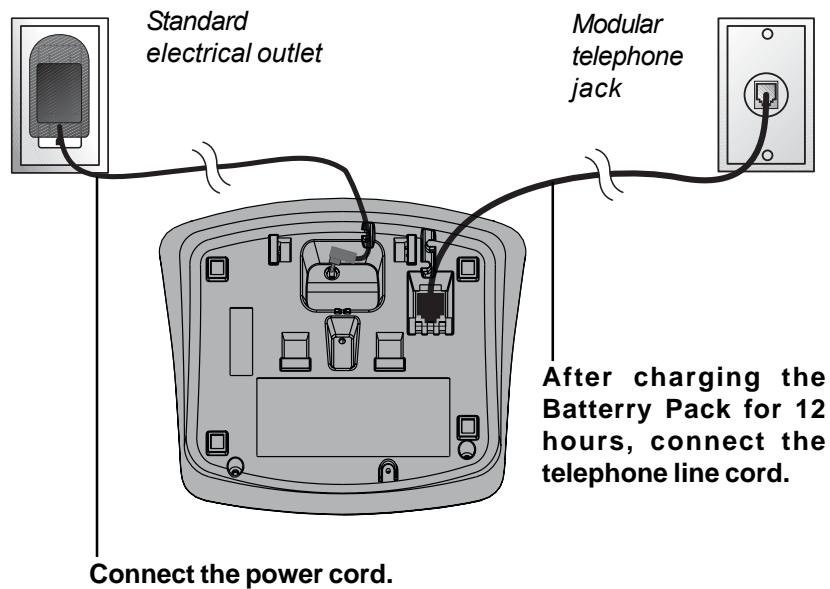



Installation

4 Charge the Handset Battery.

Place the Handset in the Base. Charge the battery for at least 12 hours the first time.

5 Check for Dial Tone.

After the batteries are charged, pick up the handset and press **PHONE**; you should hear a dial tone.

6 Set the Dial Mode.

If you have touch tone service, the phone is ready to use as soon as the batteries are charged.

If you have dial pulse (rotary) service, you'll need to change the dial mode.

- Press **PROG/CHAN** on the Handset to enter programming mode.
- Press ◀ or ▶ until the screen displays **DIAL MODE:** and the currently selected mode.
- Press **SELECT**. The current setting blinks.
- Press ▶ to select **TONE** or **PULSE**.
- Press **SELECT** to save the displayed mode.

7 Set Time and Date

If you subscribe to Caller ID service, the date and time will be set automatically with the first incoming call.

If you do not have Caller ID service, you can set the date and time manually.

- Press **PROG/CHAN**, and then press ◀ or ▶ until **DATE/TIME** is displayed. Press **SELECT**.
- The month is flashing. Press ◀ or ▶ until the screen displays the correct month. Press **SELECT**.
- The day is flashing. Press ◀ or ▶ until the screen displays the correct day. Press **SELECT**.
- The hour is flashing. Press ◀ or ▶ until the screen displays the correct hour. Press **SELECT**.
- The minute is flashing. Press ◀ or ▶ until the screen displays the correct minute. Press **SELECT**.
- **AM** or **PM** is flashing. Press ◀ or ▶ to choose between **AM** or **PM**. Press **SELECT**.



Installation

Wall Mounting

You can obtain a wall mounting accessory by calling 1-800-595-9511. In Canada, call 1-800-267-7377.

The Wall Mount bracket is designed for use on standard Wall Mount plates only.

1. Line up the tabs on the wall mount bracket with the slots on the bottom of the Base Unit. Snap the bracket firmly in place.
2. Plug the AC adapter into an electrical outlet, and the DC connector to the Base. If the battery pack has not been previously charged, place the Handset in the cradle, and allow it to charge for 12 hours.
3. Connect the telephone line cord to the jack on the Base, and the other end to the wall jack.
4. Mount the Base on the wall. Position the Base Unit so the mounting studs will fit into the holes on the wall mount bracket. Slide the Base Unit down on the mounting studs until it locks into place.

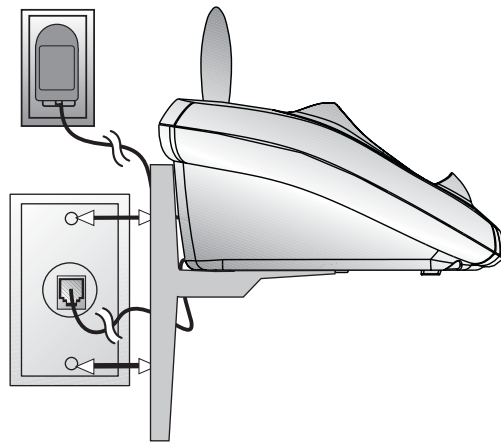

- a) Align holes on bracket with mounting studs on wall plate.
- b) Slide bracket down on studs until it locks into place.

Telephone Operation

Answer a Call
Press any key except **OFF**.

Hold
Press to put a call on hold. Press again to release hold, **OR** Lift the Handset of an extension.

Make a Call
Press **PHONE**, then dial the number **OR** Dial the number (use ◀ to backspace and correct digits), then press **PHONE** to call.

Flash/Call Waiting
Access special telephone company subscriber services.

Memory
Press **MEM** to program and access names and numbers in **Telephone Memory**.

Handset Volume
While on a call, adjust volume of what you hear.

Select
Use **SELECT** in conjunction with **PROG/CHAN** during Handset programming.

End a Call
Press **OFF** **OR** Place Handset in Base.

Exit programming.
Cancel a page.

Redial
Press **PHONE**, then press **REDIAL/PAUSE** to call last number dialed (up to 32 digits).

Program / Channel
Switch to a clearer channel while on a call.

Enter programming mode with Handset idle(on hook)

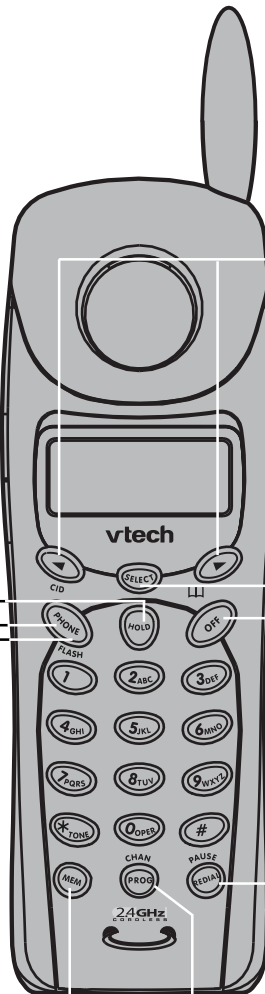

Telephone Operation

In Use/Charging

Flashes in cadence with the inbound ringing.
Flashes slowly when the Handset is in use.
Flashes rapidly when a call is on hold.
Glows steadily when the Handset is charging.

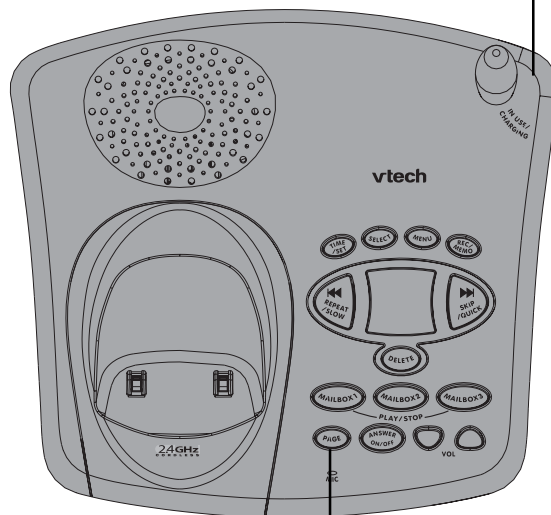

Page/Handset Locator

Press to page the Handset for up to 60 seconds. Press again to cancel, or press **OFF** on Handset.

Telephone Operation

Handset Ringer Style/Battery Save

You can select from four different Handset ringer styles, or turn the ringer off and extend the battery life.

- 1 Make sure the Handset is off.
- 2 Press **PROG/CHAN** to enter programming mode.
- 3 Press **▶** until the screen displays **RINGER:**.
- 4 Press **SELECT**. The current setting blinks, and you will hear a sample of the ring.
- 5 Press **◀** or **▶** to select **RINGER: 1, 2, 3, 4** or **OFF**. You will hear a sample of each ring.
- 6 Press **SELECT** to choose the displayed ringer setting.

Temporary Tone Dialing

If you have dial pulse (rotary) service, you can change from dial pulse to touch tone dialing during a call by pressing ***TONE**. This is useful if you need to send touch tone signals for access to telephone banking or long-distance services.

- 1 Dial the number.
- 2 Press ***TONE**. Buttons pressed after this send touch tone signals.
- 3 After you hang up, the phone automatically returns to dial pulse (rotary) service.

Headset Jack

You can use this telephone hands-free when you install any VTech 2.5 mm Headset, purchased separately.

Plug the headset into the jack located on the right side of the Handset (under the small rubber flap). Do not force the connection, but make sure the plug fits securely.

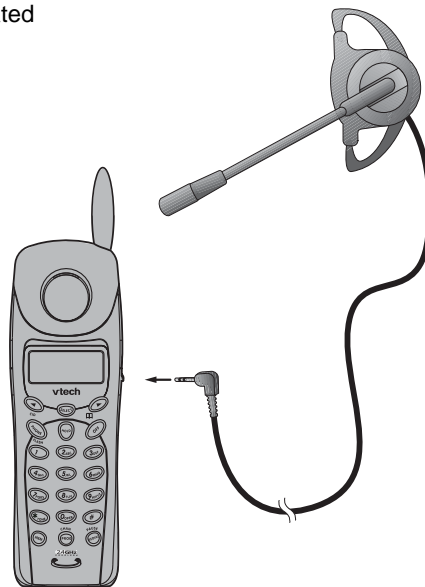

Telephone Operation

Operating Range

This cordless telephone operates within the maximum power allowed by the Federal Communications Commission (FCC). Even so, this Handset and Base can communicate over only a certain distance — which can vary with the locations of the Base and Handset, the weather, and the construction of your home or office.

If you receive a call while you are out of range, the Handset might not ring or if it does ring, the call might not connect when you press **PHONE**. Move closer to the Base, then press **PHONE** to answer the call.

If you move out of range during a phone conversation, you might hear noise or interference. To improve reception, move closer to the Base.

If you move out of range without pressing OFF, your phone will be left “off the hook.” To hang up properly, walk back into range, periodically pressing **OFF**.

Display Screen Messages

Screen Displays:	When:
** RINGING **	There is a call coming in.
CONNECTING...	The Handset is waiting for a dial tone.
PHONE ON	The Handset is in use.
** PAGING **	The Base is paging the Handset.
HOLD	There is a call on hold.
BATTERY LOW	The Battery Pack needs to be recharged.



Telephone Memory

This cordless phone can store 10 telephone numbers with names, each up to 16 digits long in memory locations you assign (0-9).

Note: Press **OFF** at any time to exit memory dial mode.

This cordless phone can store an additional 40 telephone numbers with names alphabetically in the directory. See **TELEPHONE DIRECTORY** for instructions.

Store a Number/Name in Memory

- 1 Press **PROG/CHAN**. Then press **▶** until the screen displays **MEM DIAL**.
- 2 Press **MEM**. The screen displays **ENTER 0-9**.
- 3 Press the key (0-9) for the memory location where you're storing this entry. If the selected location is empty, the screen displays **ENTER NAME**.

Note: If the location is not empty, the current entry is displayed. Press **OFF** to exit memory dial mode and start again, or follow the instructions to dial, edit or erase the current entry.

- 4 Using the chart below, enter up to 15 characters for the name you're storing with the number. Use **◀** to backspace and make corrections; use **▶** to advance and add a space.

Dial Key	Presses					
	1	2	3	4	5	6
1	1					
2	A	B	C	2		
3	D	E	F	3		
4	G	H	I	4		
5	J	K	L	5		
6	M	N	O	6		
7	P	Q	R	S	7	
8	T	U	V	8		
9	W	X	Y	Z	9	
0	0					
*	*					
#	&	'	,	-	.	#



Telephone Memory

- 5 When you finish entering the name, press **SELECT** or **PROG/CHAN**. The screen displays **ENTER NUMBER**.
- 6 Enter the telephone number. Use **◀** to backspace and make a correction. Press **REDIAL/PAUSE** to store a pause in the dialing sequence.
— OR —
Press **REDIAL/PAUSE** to display the last number dialed from this phone.
- 7 Press **SELECT** or **PROG/CHAN** to store your entry. The screen displays **DISTINCT RING?** and the current setting.
- 8 Press **◀** or **▶** to change the setting. Choose **Y** (for Yes) if you wish the phone to alert you to calls from this number by changing to a distinctive ringing pattern after the first ring. Choose **N** (for No) for a normal ringing pattern.
- 9 Press **SELECT** or **PROG/CHAN** to confirm your selection. If you chose **Y** in **Step 8**, a **D** will be displayed with the directory entry.

Edit a Number/Name Stored in Memory

- 1 Press **MEM**. The screen displays **ENTER 0-9**.
- 2 Press the memory location key of the entry you wish to edit.
- 3 When the screen displays the number you want to edit, press **SELECT**. Then press **▶** until **EDIT** flashes.

```
DIAL EDIT ERASE
9735550123
```

- 4 Press **SELECT**. The screen displays the name and number. The flashing cursor appears at the end of the name. Use **◀**, **▶** and the dial pad keys to edit the name. Press **SELECT** to move on to edit the number. Use **◀** to backspace and make corrections. Press **SELECT** to move on to edit the Distinctive Ring setting.
- 5 Press **SELECT** to save the edited information.

Delete a Number/Name Stored in Memory

- 1 Press **MEM**. The screen displays **ENTER 0-9**.
- 2 Press the memory location key of the entry you wish to delete.
- 3 When the screen displays the number you want to delete, press **SELECT**. Then press **▶** until **ERASE** flashes.

```
DIAL EDIT ERASE
9735550123
```

- 4 Press **SELECT**. The screen displays **ERASE NO YES** and the number. The current choice flashes.
- 5 Press **▶** until **YES** flashes.
- 6 Press **SELECT**. You will hear a beep confirming the deletion.



Telephone Memory

Dial a Memory Number

- 1 Press **MEM**. The screen displays **ENTER 0-9**.
- 2 Enter the memory location key of the entry you want to dial.
- 3 Press **PHONE** to dial the displayed memory number.

Telephone Directory

This cordless phone can store an additional 40 telephone numbers with names, each up to 16 digits long. Entries are stored alphabetically. For consistency with Caller ID entries, you may wish to enter last names first.

Note: Press **OFF** at any time to exit the directory.

Store a Number/Name in the Directory

- 1 Press **PROG/CHAN**. The screen displays **DIRECTORY**.
- 2 Press **SELECT**. The screen displays **ENTER NAME**.
- 3 Using the chart below, enter up to 15 characters for the name you're storing with the number. Use ◀ to backspace and make corrections; use ▶ to advance and add a space.

Dial Key	Presses					
	1	2	3	4	5	6
1	1					
2	A	B	C	2		
3	D	E	F	3		
4	G	H	I	4		
5	J	K	L	5		
6	M	N	O	6		
7	P	Q	R	S	7	
8	T	U	V	8		
9	W	X	Y	Z	9	
0	0					
*	*					
#	&	'	,	-	.	#

- 4 When you finish entering the name, press **SELECT** or **PROG/CHAN**. The screen displays **ENTER NUMBER**.
- 5 Enter the telephone number. Use ◀ to backspace and make a correction. Press **REDIAL/PAUSE** to store a pause in the dialing sequence.
— OR —
Press **REDIAL/PAUSE** to display the last number dialed from this phone.
- 6 Press **SELECT** or **PROG/CHAN**. The screen displays **DISTINCT RING?** and the current setting.



Telephone Directory

- 7 Press ◀ or ▶ to change the setting. Choose **Y** (Yes) if you wish the phone to alert you to calls from this number by changing to a distinctive ringing pattern after the first ring. Choose **N** (No) for a normal ringing pattern.
- 8 Press **SELECT** or **PROG/CHAN** to confirm your selection. If you chose **Y** in Step 7, a  will be displayed with the directory entry.

Note: When memory is full the screen displays **MEMORY FULL**, an error tone sounds, and you will not be able to store a new number until you delete a stored number.

Edit a Number/Name Stored in the Directory

- 1 Press ▶ (). The screen displays **DIRECTORY**.
- 2 Press ◀ or ▶ to scroll alphabetically through entries stored in memory — **OR** — Press the dial pad key for the first letter of the entry you want to edit.
- 3 When the screen displays the number you want to edit, press **SELECT**. Then press ▶ until **EDIT** flashes.

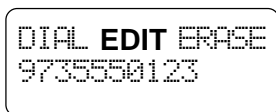

- 4 Press **SELECT**. The screen displays the name and number. The flashing cursor appears at the end of the name. Use ◀, ▶ and the dial pad keys to edit the name. Press **SELECT** to move on to edit the number. Use ◀ to backspace and make corrections. Press **SELECT** to move to edit the Distinctive Ring setting.
- 5 Press **SELECT** to save the edited information.

Delete a Number/Name Stored in the Directory

- 1 Press ▶ (). The screen displays **DIRECTORY**.
- 2 Press ◀ or ▶ to scroll alphabetically through entries stored in memory — **OR** — Press the dial pad key for the first letter of the entry you want to delete.
- 3 When the screen displays the number you want to delete, press **SELECT**. Then press ▶ until **ERASE** flashes.

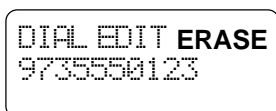

- 4 Press **SELECT**. The screen displays **ERASE NO YES** and the number. The current choice flashes.
- 5 Press ▶ until **YES** flashes.
- 6 Press **SELECT**. You'll hear a long beep confirming the deletion.



Telephone Directory

Dial a Number from the Directory

- 1 Press **▶** (). The screen displays **DIRECTORY**.
- 2 Press **◀** or **▶** to scroll alphabetically through entries stored in memory.
— **OR** —
Press the dial pad key for the first letter of the entry you want to dial.
- 3 When the screen displays the number you want to dial, press **SELECT**. **DIAL** is flashing.



DIAL BIT ERGE
973336123

- 4 Press **SELECT**. The phone automatically dials the number.
— **OR** —
When the screen displays the number you want to dial, press **PHONE**.

Caller ID Operation

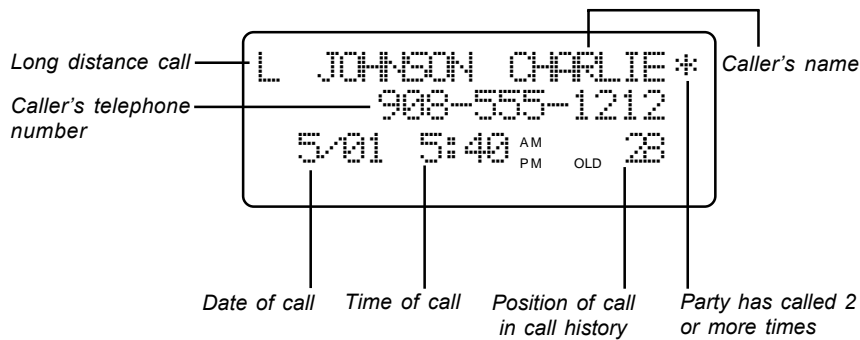

About Call History (Caller ID)

This phone assigns each incoming call a number from 1 to 99. The most recent call will have the highest number. When the memory is full, the oldest call information is deleted to make room for new incoming call information.

For each call that comes in, the screen displays the following information between the first and second rings:

- Your caller's name (15 letters are sent by your telephone company)
- The caller's area code and telephone number
- The time and date of the call

Caller ID is displayed for approximately 15 seconds after it is received.

If you answer a call before the information appears on the screen, it will not be in the call history.

Note: Press **OFF** at any time to exit call history.

Review Call History

- 1 Press ◀ (CID) to view call history.
- 2 Use ◀ and ▶ to scroll through records in call history.

Delete Records from Call History

Delete a Specific Call

- 1 Locate the record you want to delete from call history.
- 2 Press **SELECT**, then press ▶ until **ERASE** flashes.



Caller ID Operation

- 3 Press **SELECT**. The screen displays **ERASE NO YES ALL** and the phone number. The current choice flashes.
- 4 Press **▶** until **YES** flashes.
- 5 Press **SELECT**. You'll hear a long beep confirming the deletion.

Delete All Calls

- 1 While viewing call history, press **SELECT**, then press **▶** until **ERASE** flashes.



DIAL PGM ERASE
973-555-0123
5:01 5:40PM OLD 28

- 2 Press **SELECT**. The screen displays **ERASE NO YES ALL** and the phone number. The current choice flashes.
- 3 Press **▶** until **ALL** flashes, then press **SELECT**. The screen displays **ERASE ALL NO YES**. The current choice flashes.
- 4 Press **▶** until **YES** flashes.
- 5 Press **SELECT**. You will hear a long beep confirming the deletion.

Dial a Displayed Number

- 1 Locate the record in call history that you want to dial.
- 2 If you wish to change how the number is dialed, press **#**. The screen displays any alternate dialing sequences available for this call (area code + number; 1 + area code + number; number only; 1+ number).
- 3 Press **SELECT**. **DIAL** is flashing.



DIAL PGM ERASE
973-555-0123
5:01 5:40PM OLD 28

- 4 Press **SELECT** again. The number is automatically dialed.
— OR —

When the number is correctly displayed for dialing, you want to dial, press **PHONE**.

Caller ID Operation

Store a Call History Record in the Directory

- 1 Locate the record in call history you want to store in memory.
- 2 If you wish to change how the number is stored, press **#** . The screen displays any alternate dialing sequences available for this call (area code + number; 1 + area code + number; number only; 1+ number).
- 3 Press **SELECT**, then press **▶** until **PGM** flashes.

```
DIAL PGM ERASE
973-555-0123
5:01 5:40PM OLD28
```

- 4 Press **SELECT** three times. The screen displays:

```
DISTINCT RING? Y
973-555-0123
5:01 5:40 PM OLD28
```

- 5 Press **◀** or **▶** to select **Y** or **N** for distinctive ring option.
- 6 Press **SELECT**. You'll hear a beep confirming that the name and number were stored.

Display Screen Messages

Screen Displays:	When:
PRIVATE	The other party is blocking name and/or number information.
OUT OF AREA	Your phone company is unable to receive information about this caller's name and/or number.
* (after the name)	This caller has called you more than once.

Answering System Operation At The Base

Audible Indicators

This system gives you voice prompts for feature operations and voice confirmations when you press a button or complete an operation.

Setting Day/Time

1. Make sure the answering system is on.
2. Press **TIME/SET**. The system announces the clock setting, then announces: "To Set Day and Time, press **TIME/SET**."
3. Press **TIME/SET**.
4. Press **SELECT** until the system announces the correct day, then press **TIME/SET**.
5. Press **SELECT** until the system announces the correct hour, then press **TIME/SET**.
6. Press **SELECT** until the system announces the correct minute, then press **TIME/SET**. The system announces the current clock setting.

*Note: To advance the minutes by 10, press and hold **SELECT**.*

About Mailboxes

This answering system has three voice mailboxes. Callers using a touch tone phone can select the mailbox in which their messages will be recorded by pressing **1**, **2** or **3**. Otherwise, messages will be recorded in Mailbox 1.

About Announcements

- You can record two different announcements — one for normal answering and one for when you've set the system to play the announcement only.
- Use normal answering when you want the system to record callers' messages. Use Announce Only when you want to give information to callers without accepting messages.
- If you choose not to record an announcement, the system answers with a pre-recorded announcement.
- The normal answering pre-recorded announcement says: "Hello. I'm unable to answer your call right now. Please leave your name, number and a message after the tone." The **Announce Only** pre-recorded announcement says: "Hello, I'm unable to answer your call right now. Please call again. Thank you."
- By setting **Announce Only** to **ON** or **OFF**, you decide which announcement your callers will hear when the system answers a call (the system comes set for normal answering, with Announce Only turned **off**). See "**Set Announce Only**", located in the **Feature Summary** chart later in this section, to change your announcement selection.

Answering System Operation At The Base

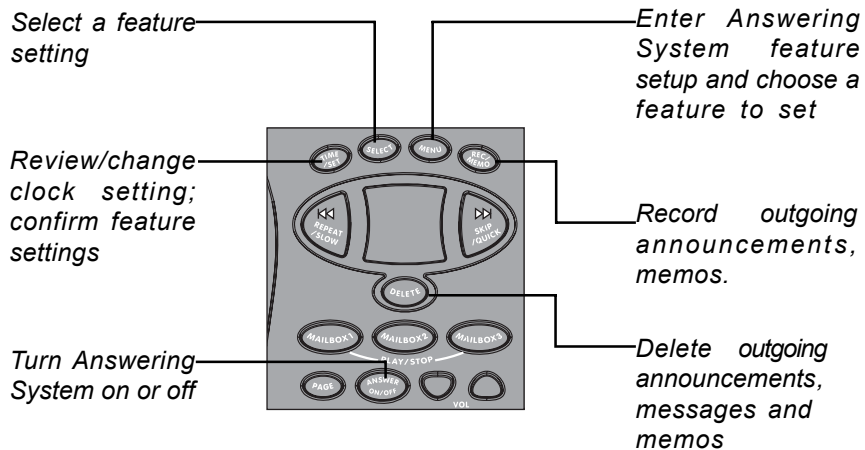

Record Your Announcement

NOTE: If you have assigned different mailboxes to different people, be sure to tell callers in your announcement to press **1**, **2**, or **3** to leave a message in the appropriate mailbox. For example:

"Thank you for calling. To leave a message for Bob, press **1** now. To leave a message for Sue, press **2** now. To leave a message for Elmo, press **3** now. Or, wait for the beep, and leave your message."

- 1 Press **MENU** until you hear "Set Outgoing Message."
- 2 Press **REC/MEMO**. After you hear "Now recording" followed by a beep, speak toward the Base to record an announcement up to 90 seconds long.
- 3 Press any **MAILBOX** button to stop recording. The system plays back your recorded message.

To review your announcement at any time:

- 1 Press **MENU** until you hear "Set Outgoing Message."
- 2 Press any **MAILBOX** button.

To delete your announcement:

Press **DELETE** during announcement playback. The system will use the pre-recorded announcement until you record a new one.

Answering System Operation At The Base

Setting Up Your Answering System

You can set up one feature at a time, or you can set up a feature and then move on to set up another feature.

1. Make sure the answering system is on.
2. Press **MENU** until the system announces the feature you want to set. Refer to the "Feature Summary" below for a description of the features and your choices.
3. Press **SELECT** until the system announces the desired setting.
4. Press **TIME/SET** to confirm your selection.
5. Press **MENU** to move on to the next feature, or press a **MAILBOX** button to exit Feature Setup.

Feature Summary

Default settings indicated by * .

System announces:	Description/directions:
"Set Security Code" 50*	Use SELECT to choose the remote access code you will use to access features and functions of the answering system from a touch tone phone. You can select any 2-digit code, from 40 to 99. <i>Note: To advance the remote access code by 10, press and hold SELECT.</i>
"Set Audible Message Alert " Off * On	When Message Alert is turned on, the base beeps once every 10 seconds when new messages have been received.
"Set Announce Only" Off * On	When you turn Announce Only On , callers hear your announcement, but cannot leave a message
"Set Base Ringer" On * Off	Turn the base ringer on or off.
"Set Number of Rings" 2 4 * 6 Toll Saver	Choose how many times the phone will ring before the system answers a call. With Toll Saver active, the system answers after two rings when you have new messages and after four rings when you have no new messages.

NOTE: You can exit Feature Setup at any time by pressing a **MAILBOX** button.

Answering System Operation At The Base

Listen to, Save & Delete Messages

The system automatically saves your messages until you delete them, and can store approximately 15 minutes of messages, memos, and announcements (up to a maximum of 99 messages). Your caller can leave a message of up to 4 minutes in length.

A **MAILBOX** key will flash to alert you to new, unplayed messages. If all messages in a mailbox have been reviewed, the key will glow steadily. A mailbox containing both old and new messages will play only the new messages first. After all new messages are played, press the **MAILBOX** key again to hear all messages.

Before playing a message, the system announces the day and time it was received. While the message plays, the Message Window displays the number of the message. After playing the last message in a mailbox, the system announces "End of messages." If the system has less than five minutes of recording time left, it announces remaining time.

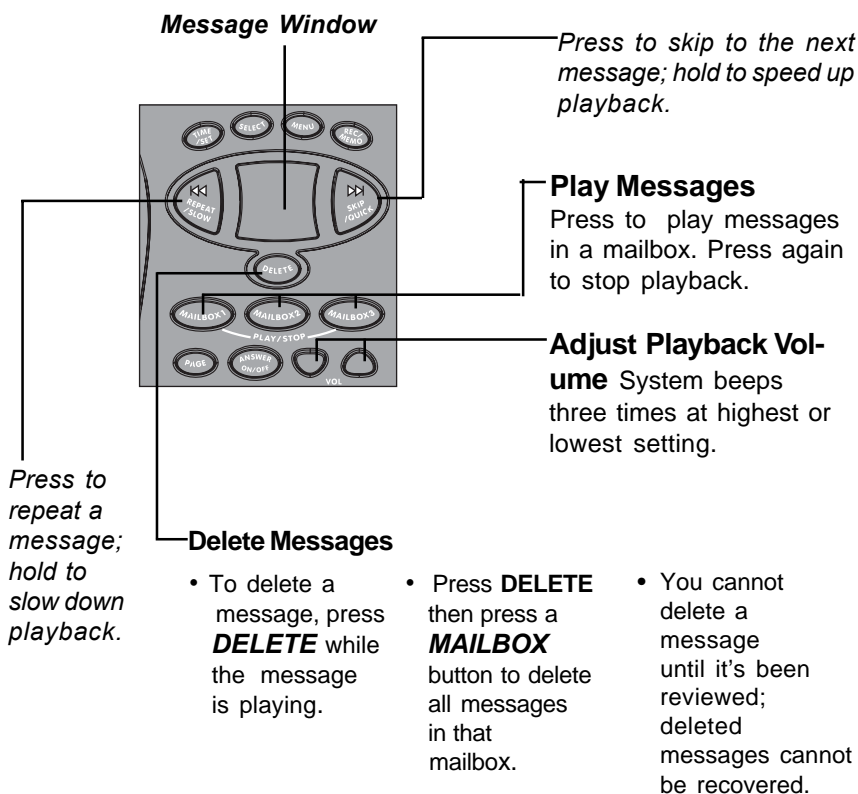

Answering System Operation At The Base

Call Screening/Intercept

- 1 Make sure the answering system is on, and set the message playback volume control above level 1 so you can hear the caller's message.
- 2 If you decide to take the call, press **PHONE** on the Handset.
- 3 If you pick up an extension phone during the announcement and the announcement does not stop right away, press and release the telephone switchhook.

Record a Memo

You can record a memo up to four minutes long, which is stored as an incoming message.

- 1 Press and release **REC/MEMO**.
- 2 Press a **MAILBOX** button to select a mailbox for the memo. After the beep, speak toward the microphone. The Message Window displays the length of your memo.
- 3 To stop recording, press the **MAILBOX** button again.

Message Window Display

Window Display: when:

0	No messages in any mailbox
1 - 99	Total number of messages in all mailboxes, or current message number during message playback
0 - 99 ↔ F	Memory is full, or total number of messages is 99
Counting 1 to 99	Duration of memo recording
99, flashing	Length of recording is more than 99 seconds
1 - 8, steady for one second	Indicates volume level selected when VOLUME ▲ or VOLUME ▼ is pressed
40 - 99	Current Remote Access Code while setting
A	Announce Only mode
ON or OFF, steady for one second	Displayed when any setting is changed from on or off
CL ↔ normal display	Clock needs to be set
--	System is answering a call or is in remote operation
-- , flashing	System is in programming mode or initializing

Answering System Operation - Access From a Remote Location

Connect with the Answering System

You can access many features of this system remotely from a touch tone phone.

- 1 Dial your telephone number.
- 2 When the system answers, enter your Remote Access Code (preset to 50). The system beeps once and then announces the number of new messages.
- 3 Enter a remote command (see "Remote Access Commands").
- 4 Press * 0 to exit remote operation.

Voice Menu

The system has voice prompts to help you with remote operation. Press * 5 to hear the menu while remotely connected to the answering system.

Remote Access Commands

Function:	Command:
Play messages in a mailbox	Press # , then the appropriate mailbox number (1 , 2 , or 3). The system plays new messages. If there are no new messages, the system plays old messages.
Repeat a message	Press # 4 while message is playing; each press backs up another message.
Skip a message	Press # 6 while message is playing; each press advances up another message.
Stop	Press # 5 .
Save messages	Hang up.
Delete message	Press # 9 while message is playing.
Review announcement	Press # 7 ; system plays announcement, then beeps.
Record announcement	Press * 7 ; after beep, record announcement, press # 5 to stop. System plays back announcement.

Answering System Operation - Access From a Remote Location

Remote Access Commands (continued)

Function:	Command:
Record memo	Press * 8 , then mailbox number where you want memo recorded; speak after beep; press # 5 when finished.
End remote access call	Press * 0 .
Turn system off	Press # 0 ; the system announces, "Answering machine off." Press # 0 again to turn the system back on.
Turn system on	When system is off, it answers after 10 rings and announces, "Please enter your security code." Enter your remote access code.

NOTE: If no key is pressed within 10 seconds of entering remote access, the voice menu will be announced. After the voice menu announcement, if no key is pressed within 20 seconds, the remote access call will automatically end.

Batteries

Battery Care and Maintenance

- This battery should remain charged up to six days with the ringer turned on and up to 10 days with the ringer off. A fully charged battery provides an average talk time of about 10 hours.
- The Battery Pack needs charging when:
 - A new battery is installed in the Handset.
 - The phone beeps twice every five seconds.
 - The screen displays **BATTERY LOW** and the low battery icon.
- Place the Handset in the Base so the CHARGING light turns on. The Battery Pack is typically fully charged in 10 hours.
- You can keep the battery fully charged by returning the Handset to the Base after each use.
- If you repeatedly get a low battery indicator, even after charging overnight, the battery should be replaced.



CAUTION: To reduce the risk of fire or injury to persons or damage to the telephone, read and follow these instructions carefully: Charge the battery provided with or identified for use with this product only in accordance with the instructions and limitations specified in the User's Manual.

Replacing the Handset Battery Pack

- 1 Remove the battery compartment cover on the Handset by pressing on the indentation and sliding the cover downward.
- 2 Lift out the old Battery Pack and disconnect.
- 3 Align the two holes in the new Battery Pack's plug with the socket pins, and snap the plug into place. Snap the Battery Pack in the compartment, as described in **Installation**, page 5.
- 4 Replace the cover by sliding it up into place.
- 5 The new Battery Pack must be charged before using the phone. Place the Handset in the Base and allow it to charge for at least 12 hours the first charge. The telephone might operate before that, but for best performance, let the Battery Pack charge fully.

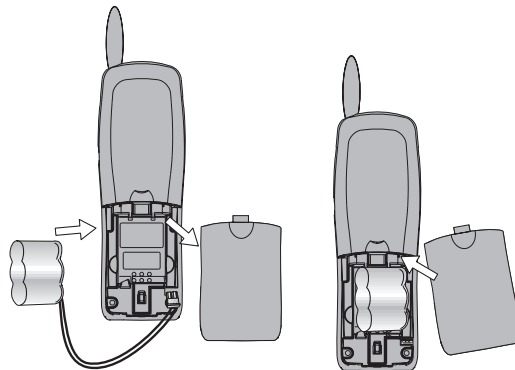



In Case Of Difficulty

If the phone doesn't work at all, check these items first:

- Make sure the AC adapter is plugged into an outlet not controlled by a wall switch.
- Make sure the telephone line cord is plugged firmly into the Base Unit and the modular jack.
- If the Handset does not beep when you press **PHONE**, the battery might need charging.
- Make sure the Battery Pack is installed correctly.
- If you have dial pulse (rotary) service on your phone line, make sure the dial mode is set to Pulse (see INSTALLATION).
- Microwave appliances may cause interference with this phone. If you experience interference, move away from the microwave

If the above suggestions don't solve the problem, try re-initializing the Handset and Base:

- 1 Disconnect the power to the Base.
- 2 Remove the Handset battery pack.
- 3 Wait a few minutes.
- 4 Connect the power to the Base.
- 5 Insert the Handset battery pack.
- 6 Put the Handset in the Base to re-initialize.

If you hear a two-beep signal when you try to use the handset:

- You might be out of range. Move closer to the Base and try again.
- If moving closer to the Base doesn't help, try following the directions above for re-initializing the Handset and Base.

If the phone does not ring when you receive a call:

- Make sure the Handset ringer is on.
- Make sure the telephone line cord is connected firmly to the Base and the telephone jack.
- Make sure the AC adapter is plugged firmly into an outlet not controlled by a wall switch.
- You might be too far from the Base; move closer.
- You might have too many extension phones on your telephone line to allow all of them to ring. Try unplugging some of them.

If you hear noise or interference when using the phone:

- You may be out of range. Move closer to the Base.
- Press and release **PROG/CHAN** to change to another of the 30 channels available. If noise is exceptionally loud, move closer to the Base before changing channels.
- Household appliances plugged into the same circuit as the Base can sometimes cause interference. Try moving the appliance or the Base to another outlet.
- Using the Handset near household appliances (microwaves, computers, television, stereos, etc.) can sometimes cause interference. Move away from appliances while using the Handset.





In Case Of Difficulty

- The layout of your home or office might be limiting the operating range. Try moving the Base to another location, preferably on an upper floor.
- If the buttons don't work, try placing the Handset in the Base for at least 15 seconds.

If you hear other calls while using your phone:

- Press **PROG/CHAN** to change to another channel.
- Disconnect the Base from the modular jack and plug in a corded telephone. If you still hear other calls, the problem is probably in your wiring or local service. Call your local telephone service company.

If you lose a call after changing channels:

You were probably almost out of range. Move closer to the Base before changing channels. Before placing another call, set the Handset in the Base for at least 15 seconds.

If you are unable to operate special telephone services or other equipment requiring touch tone signals:

If you have dial pulse (rotary) service, follow the directions under "Temporary Tone Dialing" in the TELEPHONE OPERATION section of this manual.

If messages are incomplete:

- If a caller leaves a very long message, part of it may be lost when the system disconnects the call after three minutes.
- If the caller pauses for more than seven seconds, the system stops recording and disconnects the call.
- If the system's memory becomes full during a message, the system stops recording and disconnects the call.

If you have difficulty hearing messages:

Check the volume setting on the Base.

If the system does not answer after the correct number of rings:

- Make sure that the answering system is on.
- If Toll Saver is on, the number of rings changes to two when you have new messages waiting.
- In some cases, the system may be affected by the ringing system used by the local telephone company.
- If the memory is full or the system is off, the system answers after 10 rings.

If CL appears in the Message Window:

You need to reset the clock.





In Case Of Difficulty

If the Answering System does not record messages:

- Make sure the Answering System is On. (**Answer ON/OFF** key is glowing.)
- Make sure **Announce Only** feature is set to OFF.

If the system does not respond to commands from a remote touch tone phone:

- Make sure you are calling from a touch tone phone. When you dial a number, you should hear tones. If you hear clicks instead, the phone is not a touch tone telephone.
- The answering system may not detect the Remote Access Code while your announcement is playing. Try waiting until the announcement is over before entering the code.
- Make sure you enter your Remote Access Code correctly.
- There may be noise or interference on the phone line you are using. Press keys firmly.

If your outgoing announcement isn't clear:

- When you record your announcement, make sure you speak in a normal tone of voice, about nine inches from the base.
- Make sure there is no "background" noise (TV, music, etc.) while you are recording.





Maintenance

Taking Care Of Your Telephone

Your cordless telephone contains sophisticated electronic parts, so it must be treated with care.

Avoid rough treatment

Place the Handset down gently. Save the original packing materials to protect your telephone if you ever need to ship it.

Avoid water

Your telephone can be damaged if it gets wet. Do not use the Handset outdoors in the rain, or handle it with wet hands. Do not install your Base Unit near a sink, bathtub or shower.

Electrical storms

Electrical storms can sometimes cause power surges harmful to electronic equipment.

For your own safety, use caution when using electric appliances during storms.

Cleaning your telephone

Your telephone has a durable plastic casing that should retain its luster for many years. Clean it only with a soft cloth slightly dampened with water or a mild soap. Do not use excess water or cleaning solvents of any kind.

Remember that electrical appliances can cause serious injury if used when you are wet or standing in water. If your Base Unit should fall into water, **DO NOT RETRIEVE IT UNTIL YOU UNPLUG THE POWER CORD AND TELEPHONE LINE CORDS FROM THE WALL.** Then pull the unit out by the unplugged cords.





Warranty Statement

What does this limited warranty cover?

- The manufacturer of this **VTech** product, **VTech Communications**, warrants to the holder of a valid proof of purchase (“Consumer” or “you”) that the product and all accessories provided by **VTech** in the sales package (“Product”) are free from material defects in material and workmanship, pursuant to the following terms and conditions, when installed and used normally and in accordance with operation instructions. This limited warranty extends only to the Consumer for Products purchased and used in the United States of America.

What will VTech Communications do if the Product is not free from material defects in materials and workmanship during the limited warranty period (“Materially Defective Product”)?

- During the limited warranty period, VTech’s authorized service representative will repair or replace at VTech’s option, without charge, a Materially Defective Product. If we repair this product, we may use new or refurbished replacement parts. If we choose to replace this product, we may replace it with a new or refurbished product of the same or similar design. VTech will return repaired or replacement products to you in working condition. VTech will retain defective parts, modules, or equipment. Repair or replacement of Product, at VTech’s option, is your exclusive remedy. You should expect the repair or replacement to take approximately 30 days.

How long is the limited warranty period?

- The limited warranty period for the product extends for ONE(1)YEAR from the date of purchase if we repair or replace a Materially Defective Product under the terms of this limited warranty. This limited warranty also applies to repaired or replacement Products for a period of either (a) 90 days from the date the repaired or replacement Product is shipped to you or (b) the time remaining on the original one-year warranty; whichever is longer.

What is not covered by this limited warranty?

This limited warranty does not cover

1. Product that has been subjected to misuse, accident, shipping or other physical damage, improper installation, abnormal operation or handling, neglect, inundation, fire, water or other liquid intrusion; or
2. Product that has been damaged due to repair, alteration or modification by anyone other than an authorized service representative of VTech; or
3. Product to the extent that the problem experienced is caused by signal conditions, network reliability or cable or antenna systems; or
4. Product to the extent that the problem is caused by use with non-VTech electrical accessories; or





Warranty Statement

5. Product whose warranty/quality stickers, Product serial numbers plates or electronic serial numbers have been removed, altered or rendered illegible; or
6. Product purchased, used, serviced, or shipped for repair from outside the United States, or used for commercial or institutional purposes (including but not limited to Products used for rental purposes); or
7. Product returned without valid proof of purchase (see 2 below); or
8. Charges for installation or set up, adjustment of customer controls, and installation or repair of systems outside the unit.

How do you get warranty service?

- To obtain warranty service in the United States of America, call 1-800-595-9511 for instructions regarding where to return the Product. Before calling for service, please check the user's manual. A check of the Product controls and features may save you a service call.
- Except as provided by applicable law, you assume the risk of loss or damage during transit and transportation and are responsible for delivery or handling charges incurred in the transport of Product(s) to the service location . VTech will return repaired or replaced product under this limited warranty to you, transportation, delivery or handling charges prepaid .VTech assumes no risk for damage or loss of the Product in transit.
- If the Product failure is not covered by this limited warranty, or proof of purchase does not meet the terms of this limited warranty, VTech will notify you and will request that you authorize the cost of repair prior to any further repair activity. You must pay for the cost of repair and return shipping costs for the repair of Products that are not covered by this limited warranty.



What must you return with the Product to get warranty service?

1. Return the entire original package and contents including the Product to the VTech service location along with a description of the malfunction or difficulty;
2. Include "valid proof of purchase" (sales receipt) identifying the Product purchased (Product model) and the date of purchase or receipt; and
3. Provide your name, complete and correct mailing address, and telephone number.

Other Limitations

- This warranty is the complete and exclusive agreement between you and VTech. It supersedes all other written or oral communications related to this Product. VTech provides no other warranties for this product. The warranty exclusively describes all of VTech's responsibilities regarding the product. There are no other express warranties. No one is authorized to make modifications to this limited warranty and you should not rely on any such modification.





Warranty Statement

State Law Rights: This warranty gives you specific legal rights, and you may also have other rights which vary from state to state.

Limitations: Implied warranties, including those of fitness for a particular purpose and merchantability (an unwritten warranty that the product is fit for ordinary use) are limited to one year from date of purchase. Some states do not allow limitations on how long an implied warranty lasts, so the above limitation may not apply to you.

- In no event shall VTech be liable for any indirect, special, incidental, consequential, or similar damages (including, but not limited to lost profits or revenue, inability to use the product, or other associated equipment, the cost of substitute equipment, and claims by third parties) resulting from the use of this product. Some states do not allow the exclusion or limitation of incidental or consequential damages, so the above limitation or exclusion may not apply to you.



FCC, ACTA and IC Regulations

This equipment complies with Parts 15 of the Federal Communications Commission (FCC) rules for the United States. It also complies with regulations RSS210 and CS-03 of Industry and Science Canada. Operation is subject to the following two conditions: (1) this device may not cause interference, and (2) this device must accept any interference, including interference that may cause undesired operation of the device. A label is located on the underside of the Base Unit containing either the FCC registration number and Ringer Equivalence Number (REN) or the IC registration number and Load Number. You must, upon request, provide this information to your local telephone company.

This equipment is compatible with inductively coupled hearing aids.

Should you experience trouble with this telephone equipment, please contact:

VTech Communications Inc

CUSTOMER SERVICE. at 1-800-595-9511. In Canada, call VTech Telecommunications Canada Ltd. at 1-800-267-7377.

For repair/warranty information, the telephone company may ask you to disconnect this equipment from the line network until the problem has been corrected.

FCC Part 15

Warning: Changes or modifications to this unit not expressly approved by the party responsible for compliance could void the user's authority to operate the equipment.

The equipment has been tested and found to comply with part 15 of the FCC rules. These limits are designed to provide reasonable protection against harmful interference in a residential installation. This equipment generates, uses and can radiate radio frequency energy and, if not installed and used in accordance with the instructions, may cause harmful interference to radio communications. However, there is no guarantee that interference will not occur in a particular installation. If this equipment does cause harmful interference to radio or television reception, which can be determined by turning the equipment off and on, the user is encouraged to try and correct the interference by one or more of the following measures:

- Reorient or relocate the receiving antenna.
- Increase the separation between the equipment and receiver.
- Connect the equipment into an outlet or on a circuit different from that to which the receiver is connected.
- Consult the dealer or an experienced radio/TV technician for help.

FCC Part 68 and ACTA

If this equipment was approved for connection to the telephone network prior to July 23, 2001, it complies with Part 68 of the Federal Communications Commission (FCC) rules. If the equipment was approved after that date, it complies with the Part 68 rules and with Technical Requirements for Connection of Equipment to the Telephone Network adopted by the Administrative Council for Terminal Attachments (ACTA). We are required to provide you with the following information.





FCC, ACTA and IC Regulations

1. Product identifier and REN information

The label on the back or bottom of this equipment contains, among other things, an identifier indicating product approval and the Ringer Equivalence Number (REN). This information must be provided to your local telephone company upon request. For equipment approved prior to July 23, 2001, the product identifier is preceded by the phrase "FCC Reg No." and the REN is listed separately. For equipment approved after that date, the product identifier is preceded by "US" and a colon (:), and the REN is encoded in the product identifier without a decimal point as the sixth and seventh characters following the colon. For example, the product identifier US:AAAEQ03T123XYZ would indicate an REN of 0.3.

The REN is used to determine how many devices you may connect to your telephone line and still have them ring when you are called. In most, but not all areas, the sum of all RENs should be five (5.0) or less. You may want to contact your local telephone company for more information.

2. Connection and use with the nationwide telephone network

The plug and jack used to connect this equipment to the premises wiring and the telephone network must comply with the applicable Part 68 rules and technical requirements adopted by ACTA. A compliant telephone cord and modular plug is provided with this product. It is designed to be connected to a compatible modular jack that is also compliant. An RJ11 jack should normally be used for connecting to a single line and an RJ14 jack for two lines. See Installation Instructions in the user's manual. This equipment may not be used with Coin Telephone Lines or with Party Lines. If you have specially wired alarm dialing equipment connected to your telephone line, ensure the connection of this equipment does not disable your alarm equipment. If you have questions about what will disable alarm equipment, consult your telephone company or a qualified installer.

3. Repair instructions

If this equipment is malfunctioning, it must be unplugged from the modular jack until the problem has been corrected. Repairs to this telephone equipment can only be made by the manufacturer or its authorized agents. For repair procedures, follow the instructions outlined under the Limited Warranty.

4. Rights of the telephone company

If this equipment is causing harm to the telephone network, the telephone company may temporarily discontinue your telephone service. The telephone company is required to notify you before interrupting service. If advance notice is not practical, you will be notified as soon as possible. You will be given the opportunity to correct the problem and the telephone company is required to inform you of your right to file a complaint with the FCC. Your telephone company may make changes in its facilities, equipment, operation, or procedures that could affect the proper functioning of this product. The telephone company is required to notify you if such changes are planned.

5. Hearing aid compatibility

If this product is equipped with a corded or cordless Handset, it is hearing aid compatible.





FCC, ACTA and IC Regulations

6. Programming/testing of emergency numbers

If this product has memory dialing locations, you may choose to store police, fire department and emergency medical service telephone numbers in these locations. If you do, please keep three things in mind:

- a We recommend that you also write the telephone number on the directory card, so that you can still dial the emergency number manually if the memory dialing feature doesn't work.
- b This feature is provided only as a convenience, and the manufacturer assumes no responsibility for customer reliance upon the memory feature.
- c Testing the emergency telephone numbers you have stored is not recommended. However, if you do make a call to an emergency number:
 - You must remain on the line and briefly explain the reason for the call before hanging up.
 - Programming/testing of emergency numbers should be performed during off-peak hours, such as in the early morning or late evening, when the emergency services tend to be less busy.

IC (Industry Canada)

This telephone is registered for use in Canada.

The term "IC:" before the radio certification number only signifies that Industry Canada technical specifications were met.

Notice:

This equipment meets the applicable Industry Canada Terminal Equipment Technical Specifications. This is confirmed by the registration number. The abbreviation, IC, before the registration number signifies that registration was performed based on a Declaration of Conformity indicating that Industry Canada technical specifications were met. It does not imply that Industry Canada approved the equipment.

Notice:

The Ringer Equivalence Number (REN) for this terminal equipment is 0.1. The REN assigned to each terminal equipment provides an indication of the maximum number of terminals allowed to be connected to a telephone interface. The termination on an interface may consist of any combination of devices subject only to the requirement that the sum of the Ringer Equivalence Numbers of all the devices does not exceed five.

Before installing this equipment, users should ensure that it is permissible to be connected to the facilities of the local telecommunications company. The equipment must also be installed using an acceptable method of connection. The customer should be aware that compliance with the above conditions may not prevent degradation of services in some situations.

Repairs to certified equipment should be made by an authorized Canadian maintenance facility designated by the supplier. Any repairs or alterations made by the user to this equipment, or equipment malfunctions, may give the telecommunications company cause to request the user to disconnect the equipment.



The RBRC[®] Seal



The RBRC[®] Seal on the nickel-cadmium battery indicates that VTech Communications, INC. is voluntarily participating in an industry program to collect and recycle these batteries at the end of their useful lives, when taken out of service within the United States and Canada.

The RBRC[®] program provides a convenient alternative to placing used nickel-cadmium batteries into the trash or municipal waste, which may be illegal in your area.

VTech's participation in RBRC[®] makes it easy for you to drop off the spent battery at local retailers participating in the RBRC program or at authorized VTech product service centers. Please call **1-800-8-BATTERY™** for information on Ni-Cd battery recycling and disposal bans/restrictions in your area. VTech's involvement in this program is part of its commitment to protecting our environment and conserving natural resources.

RBRC[®] is a registered trademark of Rechargeable Battery Recycling Corporation.

Technical Specifications

FREQUENCY CONTROL

Crystal controlled
PLL synthesizer

WEIGHT

Handset : 148 grams
Base : 344 grams

TRANSMIT FREQUENCY

Base: 2411.15 - 2418.4 MHz
Handset: 912.75 - 917.10 MHz

POWER REQUIREMENTS

Handset : 400mAH Ni-Cd
Battery Pack

RECEIVE FREQUENCY

Base: 912.75 - 917.10 MHz
Handset: 2411.15 - 2418.4 MHz

Base : 9V DC @ 400mA

MEMORY

Speed Dial: 10 Memory locations
16 digits per location

CHANNELS

30 Channels

Directory: 40 Memory locations
16 digits per location

NOMINAL RANGE EFFECTIVE RANGE

Maximum power allowed by FCC and IC. Actual operating range may vary according to environmental conditions at the time of use.

CID: Alphanumeric Display
99 Memory locations

SIZE

Handset : 42mm x 57mm x 205mm
Base : 148mm x 171mm x 112mm

**SPECIFICATIONS ARE TYPICAL
AND MAY CHANGE WITHOUT
NOTICE.**



Table Of Contents

IMPORTANT SAFETY INSTRUCTIONS	1
BEFORE YOU BEGIN.....	3
About Caller Identification	3
Parts Check List.....	4
Getting Started.....	5
INSTALLATION	5
Before You Install.....	5
Table/Desk Installation.....	6
Wall Mounting.....	8
Basic Operation.....	9
Telephone Operation.....	9
Make a Call	9
Answer a Call	9
End a Call	9
Program/Channel	9
Redial	9
Handset Volume.....	9
Flash/Call Waiting	9
Hold.....	9
Select.....	9
Memory.....	9
In Use/Charging.....	10
Page/Handset Locator.....	10
Handset Ringer Style/Battery Save	11
Temporary Tone Dialing	11
Headset Jack	11
Operating Range.....	12
Display Screen Messages	12
Telephone Memory	13
Store a Number/Name in Memory	13
Edit a Number/Name Stored in Memory	14
Delete a Number/Name Stored in Memory	14
Dial a Memory Number.....	15
Telephone Directory.....	16
Store a Number/Name in the Directory	16
Edit a Number/Name Stored in Memory	17
Delete a Number/Name Stored in the Directory	17
Dial a Number from the Directory	18





Table Of Contents

Caller ID Operation.....	19
About Call History.....	19
Review Call History.....	19
Delete Records from Call History.....	19
Dial a Displayed Number.....	20
Store a Call History Record in the Directory.....	21
Display Screen Messages.....	21
Answering System Operation At The Base.....	22
Audible Indicators	22
Setting Day/Time.....	22
About Mailboxes	22
About Announcements.....	22
Record Your Announcement	23
Setting up Your Answering System.....	24
Feature Summary.....	24
Listen to, Save & Delete Messages.....	25
Call Screening/Intercept	26
Record a Memo	26
Message Window Display	26
Answering System Operation - Access	
From a Remote Location.....	27
Connect with the Answering System	27
Voice Menu.....	27
Remote Access Commands.....	27
Batteries.....	29
Battery Care and Maintenance.....	29
Replacing the Handset Battery Pack.....	29
Additional Information.....	30
In Case of Difficulty.....	30
Maintenance.....	33
Warranty Statement.....	34
FCC, ACTA AND IC Regulations.....	37
The RBRC Seal.....	40
Technical Specifications.....	41





vtech

VTECH TELECOMMUNICATIONS LTD.

A member of THE VTECH GROUP OF COMPANIES.

Distributed in the U.S.A. by VTech Communications Inc, Beaverton, OR, 97008.

Distributed in Canada by VTech Telecommunications Canada Ltd., Suite 200-7671 Alderbridge Way, Richmond, B.C. V6X 1Z9.

Copyright 2003 for VTECH TELECOMMUNICATIONS LTD.
Printed in China

91-5389-10-00
ISSUED 0





2.4GHz

vtech



vtech
2.4GHz

MIC





2.4GHz CORDLESS PHONE
WITH DIGITAL ANSWERING DEVICE

PAGE

TIME/SET

SELECT

MENU

ANSWER
ON/OFF

REPEAT

SKIP

MAILBOX 1

MAILBOX 2

MAILBOX 3

PLAY/STOP

DELETE

REC/MEMO

VOL

vtech

2.4GHz

MIC

IN USE / CHARGING



S/N GA0801-
538

